

DISS. ETH NO. 19764

**LOCAL ANALYSIS OF RECTIFIABLE AND
NON-RECTIFIABLE CALIBRATED CYCLES OF
DIMENSION 2**

A dissertation submitted to

ETH ZURICH

for the degree of

Doctor of Sciences

presented by

COSTANTE BELLETTINI

M.Sc. Università di Pisa

and Scuola Normale Superiore di Pisa

born June 8, 1983

citizen of Italy

accepted on the recommendation of

Prof. Dr. Tristan Rivière, examiner

Prof. Dr. Camillo De Lellis, co-examiner

2011

to my parents

Acknowledgments

I would like to express my great gratitude to my advisor Professor Tristan Rivière for his guidance and support during my PhD studies, for his contagious enthusiasm and for the fruitful discussions during which he shared with me his deep insights into the subject and his far-reaching intuitions.

I further wish to thank Professor Camillo De Lellis for the both useful and encouraging conversations we had over the years, as well as for accepting the task of being co-examiner.

My research was partially supported in 2010-2011 by the Swiss Polytechnic Federal Institute Graduate Research Fellowship ETH-01 09-3 and in 2010 by the Swiss National Science Foundation Graduate Research Fellowship 200021-126489. I am as well very grateful to all my colleagues at ETH Zurich for their friendship and the conversations we had and to the Department of Mathematics for the excellent research and working conditions.

I thank my family, my girlfriend Tanja and all my friends for their love and encouragement and for the pleasant moments we spent together, providing the necessary distraction from work.

I finally wish to dedicate this thesis to my parents, Anna and Oliviero, for all that they have done for me during my life.

Contents

Abstract	9
Riassunto	11
1 Introduction	13
1.1 Calibrations and Geometric Measure Theory	13
1.1.1 Historical example	13
1.1.2 Notions from Geometric Measure Theory	15
1.1.3 Calibrated currents	17
1.1.4 Some interesting calibrations	19
1.2 Regularity questions	20
1.3 Calibrations: beyond Plateau's problem	22
1.4 Non-rectifiable currents	23
1.5 Results of this thesis	24
1.5.1 Special Legendrian cycles in S^5 : overview	26
1.5.2 Semi-calibrated legendrians in a contact 5-manifold	33
1.5.3 Positive $(1, 1)$ -normal cycles: tangent cones.	36
2 Special Legendrian cycles in S^5	45
2.1 Positive foliations	45
2.2 Tools from intersection theory	53
2.3 Before the induction	58
2.3.1 Uniqueness of the tangent cone	58
2.3.2 Easy case of non-accumulation	65
2.3.3 Relative Lipschitz-type estimate	68
2.4 High order singularities	71
2.4.1 Logical Structure of the proof	71
2.4.2 Choice of Coordinates	73
2.4.3 Multi-valued graph	75
2.4.4 PDEs and Average	76
2.4.5 Unique continuation	85
2.5 Lower Order Singularities	102

3	Semi-calibrated Legendrians in 5-D	123
3.1	Almost complex structures and two-forms.	126
3.1.1	Self-dual and anti self-dual forms.	126
3.1.2	From a two-form to J	127
3.1.3	From J to a two-form.	131
3.2	Proof of theorem 3.0.2	132
3.2.1	Positive foliations	132
3.2.2	Structure of the proof	149
3.3	Final remarks	150
4	Tangent cones to positive $(1, 1)$ cycles	155
4.1	Tangent cones to $(1, 1)$ -normal cycles.	158
4.2	Pseudo holomorphic polar coordinates	160
4.3	Algebraic blow up	166
4.4	Proof of the result	176
4.5	Kiselman's counterexample revisited	179
A	Almost monotonicity formula	185
B	Behaviour under diffeomorphisms	187
	Bibliography	191
	Curriculum Vitae	197

Abstract

This dissertation deals with local regularity issues for rectifiable and non-rectifiable cycles of dimension 2.

In chapters 2 and 3 we prove optimal regularity results for *Special Legendrian* integral cycles in 5-dimensional contact manifolds.

The most well-known example, treated in chapter 2, is that of Special Legendrian integral cycles in S^5 , which are the links of Special Lagrangian cones in \mathbb{R}^6 .

The more general case, described in chapter 3, happens in an arbitrary 5-dimensional contact manifold, where we consider cycles whose approximate tangents are invariant for the action of an almost complex structure J that satisfies, for any vector v in the horizontal distribution, $d\alpha(v, Jv) = 0$.

We prove that these integral cycles are in fact smooth Legendrian curves except possibly at isolated points and we investigate how the mentioned structures J are related to semi-calibrations.

In chapter 4 we turn our attention to normal currents of dimension 2, positive (or semi-calibrated) with respect to a two-form. More precisely we are concerned with pseudo-holomorphic 2-currents having finite mass and zero boundary: they are called *positive (1,1) normal cycles*. We prove a uniqueness result for tangent cones at non-isolated points of positive density (absolute uniqueness is already known to fail). This result also applies to Special Legendrian cycles, but is shown in much wider generality.

Riassunto

Questa tesi di dottorato verte su questioni di regolarità locale per correnti di dimensione 2, sia rettificabili che non rettificabili.

Nei capitoli 2 and 3 si dimostrano risultati ottimali di regolarità per *Legendriane Speciali* intere e senza bordo in una varietà di contatto di dimensione 5. L'esempio più noto è quello delle Legendriane Speciali in S^5 , trattate nel capitolo 2: esse si ottengono intersecando un cono Lagrangiano Speciale in \mathbb{R}^6 con l'ipersfera.

Il caso più generale, descritto nel capitolo 3, si osserva in una varietà di contatto arbitraria, di dimensione 5. Qui consideriamo correnti intere senza bordo i cui tangenti approssimati sono invarianti per l'azione di J , essendo quest'ultima una struttura quasi complessa che soddisfa la condizione $d\alpha(v, Jv) = 0$ per tutti i vettori v nella distribuzione orizzontale.

Si dimostra qui che tali correnti sono, al più fuori da un insieme di punti isolati, curve legendriane lisce. Si discute inoltre come le strutture J descritte siano legate alle semi-calibrazioni.

Nel capitolo 4 l'attenzione si sposta su correnti bidimensionali non necessariamente rettificabili. Ci occupiamo di correnti positive (o semi-calibrate) rispetto a una forma di grado due; più precisamente, studiamo correnti senza bordo e con massa finita di tipo pseudo-olomorfo, anche dette *normali positive di tipo (1, 1)*. Dimostriamo un risultato di unicità per i coni tangenti nei punti a densità positiva non isolati (è noto che non c'è unicità assoluta). Il risultato si applica in modo immediato anche alle Legendriane Speciali di cui si è parlato sopra, è tuttavia mostrato in un contesto molto più generale.

Chapter 1

Introduction

1.1 Calibrations and Geometric Measure Theory

Calibrations have appeared in analysis and geometry more and more in the last 50 years. The word “*calibration*” was used for the first time in 1982 by Harvey and Lawson ([30]): let us start with an example, already analysed earlier, where the key features of *calibrated geometries* had already been observed.

1.1.1 Historical example

Endow \mathbb{R}^4 with the standard flat metric and coordinates (x_1, y_1, x_2, y_2) . The two-form

$$\omega = dx^1 \wedge dy^1 + dx^2 \wedge dy^2$$

acts by definition on 2-vectors: for example, $\omega\left(\frac{\partial}{\partial x^1} \wedge \frac{\partial}{\partial y^1}\right) = 1$ and $\omega\left(\frac{\partial}{\partial x^1} \wedge \frac{\partial}{\partial x^2} + \frac{\partial}{\partial y^1} \wedge \frac{\partial}{\partial y^2}\right) = 0$.

As elements of the exterior algebra, 2-vectors are just algebraic objects: if however we just look at unit, simple 2-vectors, there is a natural geometric meaning to assign, namely we have a bijective correspondence

$$\left\{ \begin{array}{l} \text{Oriented 2-D planes in } \mathbb{R}^4 \\ \text{Oriented Span of } (v_1, v_2) \end{array} \right\} \xleftrightarrow{1-1} \left\{ \begin{array}{l} \text{unit simple 2-vectors} \\ v_1 \wedge v_2 \end{array} \right\}.$$

We can therefore speak of the action of ω on oriented 2-dimensional planes. Recall that the norm of a simple 2-vector $v_1 \wedge v_2$ is just the area of the parallelopete spanned by v_1 and v_2 .

The following observations were made at different stages and in different contexts, more or less explicitly, by Wirtinger [63] in 1936, De Rham [19] in 1957 and Federer [26] in 1965.

- ω is a two-form, therefore we can compare it, on any 2-D oriented plane with the 2-D area form. It turns out that ω is always less or equal than the area form:

$$|v_1 \wedge v_2| = 1 \Rightarrow \omega(v_1 \wedge v_2) \leq 1.$$

- When is equality reached in the previous statement? It is a fairly elementary computation to check that for unit simple 2-vectors $v_1 \wedge v_2$ we have

$$\omega(v_1 \wedge v_2) = 1 \Leftrightarrow v_1 \wedge v_2 \text{ is a complex line of } \mathbb{C}^2 \cong \mathbb{R}^4.$$

Here we are identifying \mathbb{R}^4 and \mathbb{C}^2 in the standard way, so that $z_1 = x_1 + iy_1$ and $z_2 = x_2 + iy_2$ are the usual complex coordinates. A complex line is then a plane of (real) dimension 2, that is invariant under multiplication by i .

- Denote by $\mathcal{G}(\omega)$ the set of complex lines in $\mathbb{C}^2 \cong \mathbb{R}^4$, that are identified (as just seen) with unit simple 2-vectors on which ω gives the value 1. Let $S \subset \mathbb{R}^4$ be a 2-dimensional oriented submanifold with boundary whose tangent planes $T_x S$, at all points $x \in S$, enjoy the following property (such S is also called a complex subvariety):

$$\forall x \ T_x S \in \mathcal{G}(\omega).$$

Then S is **mass minimizing** for its boundary.

The proof of the last statement is rather straightforward: denote by dA the Area-form and let T be a comparison surface, i.e. $\partial T = \partial S$. This means that there exists a 3-dimensional submanifold whose boundary is $T - S$ and we can write

$$\begin{aligned} \text{Area}(S) &= \int_S dA = \int_S \omega = \\ \omega \text{ closed} \\ \text{Stokes thm.} \quad \Rightarrow &= \int_T \omega \leq \int_T dA = \text{Area}(T). \end{aligned} \quad (1.1)$$

Therefore S minimizes the area among surfaces with its same boundary. This is the classical **Plateau problem** of finding (and studying) the surface of minimal area spanning a given boundary: the original works of Plateau ([46]) with soap films aimed to study 2-dimensional surfaces in \mathbb{R}^3 , the problem has then been addressed and studied for general m -dimensional surfaces in \mathbb{R}^N , with $m < N$.

We have just seen that complex subvarieties in \mathbb{R}^4 are minimizers for their boundaries. Federer was the first one to observe that the following surfaces in the unit ball $B_1^4(0)$ of $\mathbb{R}^4 \cong \mathbb{C}^2$ are then also minimizers of the area functional:

$$\{z_1 = 0\} \cup \{x_2 = 0\} \cap B_1^4(0) \text{ and } \{z_1^2 = z_2^3\} \cap B_1^4(0).$$

The boundaries are respectively a disjoint union of two unit circles and a connected curve.

What is new about these surfaces? Both of them are **singular** at the origin, in the sense that in any small ball centered at the origin each surface does not look like a classical submanifold: in the first case there is an intersection of two disks, in the second we have a so-called branch point.

The proof given in (1.1) works however just the same: Stokes theorem can be used by cutting out a small ball around the origin, keeping track of the boundary that is thus created. Shrinking the little ball to a point shows that the contribution of the additional boundary goes to 0 in the limit, so the argument shows again that we are dealing with area-minimizers.

Federer was thus able to show that area-minimizers can indeed have singular points, answering a question still open back then. Federer was actually working with the so-called integral currents, the “generalized submanifolds” of Geometric Measure Theory, introduced some years before by himself and Fleming ([27]). What makes integral currents suitable for *Plateau’s problem* is that they enjoy enough compactness to yield the **existence** of a minimizer for a given boundary, by using the direct method of calculus of variations.

Let us recall the main notions, referring to [25], [28] or [43] for a more complete exposition. The next subsection is just a brief reminder.

1.1.2 Notions from Geometric Measure Theory

Currents were first introduced by De Rham as the dual space of smooth and compactly supported differential forms (see [19]). For 0-forms, i.e. functions, they are just Schwartz distributions.

Some distinguished classes of currents have, since the sixties, played a key role in Geometric Measure Theory (see [27], [25] and [28]). One of them, of major interest in chapters 2 and 3, is the class of *integral currents*.

An integral m -cycle C in M is an integer multiplicity rectifiable current of dimension m without boundary. The definitions are as follows:

- (i) *Rectifiability*: there is a countable family of oriented C^1 submanifolds N_i ($i = 1, 2, 3, \dots$) of dimension m in M ; in each of them we take a \mathcal{H}^m -measurable subset \mathcal{N}_i , so that the \mathcal{N}_i 's are disjoint; let moreover \mathcal{N}_0 be a \mathcal{H}^m -null set. The union $\mathcal{C} = \cup_i \mathcal{N}_i \cup \mathcal{N}_0$ is a so-called *oriented rectifiable set*.

\mathcal{C} possesses an *oriented approximate tangent plane* \mathcal{H}^m -a.e. (see [25] or [28]).

- (ii) *Integer multiplicity*: on \mathcal{C} an integer valued and locally summable *multiplicity function* θ is given, $\theta \in L^1_{\text{loc}}(\mathcal{C}; \mathbb{Z})$; the action of the current C on any m -form ψ , that is smooth and compactly supported in M , is given by

$$C(\psi) = \int_{\mathcal{C}} \theta(x) \langle \psi_x, \xi_x \rangle d\mathcal{H}^m(x),$$

where ξ_x is the oriented tangent at x represented as a unit simple vector.

- (iii) *Boundary*: the boundary ∂C of a current C of dimension m is defined to be the $(m - 1)$ -dimensional current whose action on any smooth $(m - 1)$ -form α , that is compactly supported in M , is given as

$$(\partial C)(\alpha) := C(d\alpha).$$

The term *cycle* refers to the fact that the boundary is 0.

The class of integer-multiplicity, rectifiable currents of dimension m in M is denoted by $\mathcal{R}_m(M)$. The support $\text{spt}(C)$ of the current is defined as the complement of the open set

$$\cup \{A : A \text{ is open and } C(\psi) = 0 \text{ for all } m\text{-forms } \psi \text{ compactly supported in } A\}.$$

Integral currents are denoted by $\mathcal{I}_m(M)$ and are defined as the currents in $\mathcal{R}_m(M)$ whose boundary is a current in $\mathcal{R}_{m-1}(M)$. A family of currents in $\mathcal{I}_m(M)$ with equibounded masses¹ and boundary masses enjoys *compactness*: this important theorem makes them very suitable for minimization problems.

¹The notion of mass for an arbitrary current is recalled in the next subsection. For the moment it suffices to say that, for a rectifiable current, the mass is just the integral of $|\theta|$ with respect to the measure $\mathcal{H}^m \llcorner \mathcal{C}$.

Without loss of generality one can assume the multiplicity θ to be strictly positive: for that purpose it is enough to choose the appropriate orientation for the oriented rectifiable set and neglect the part where $\theta = 0$. With this in mind, one can always express the action of a rectifiable current C by means of a rectifiable set \mathcal{C} on which a multiplicity function $\theta \in L^1_{\text{loc}}(\mathcal{C}; \mathbb{N} \setminus \{0\})$ is given: this underlying rectifiable set \mathcal{C} is referred to as the *carrier* of the current C .

We recall the notions of Smooth Points and Singular Points. A point $x \in \mathcal{C}$ is said to be a *smooth point* if there is a ball $B_r(x)$ in which the current acts as a smooth m -submanifold \mathcal{V} , i.e. if there is some constant $N \in \mathbb{N}$ such that for any smooth m -form ψ compactly supported in $B_r(x)$

$$C(\psi) = N \int_{\mathcal{V}} \psi.$$

The set of smooth points is open in \mathcal{C} by definition; its complement in \mathcal{C} is called the *singular set of C* , denoted by *Sing C* .

Unless the singular set is “very small”, an integral current can be a really irregular and wild object.

While integral currents are the “submanifolds” of Geometric Measure Theory, the wider class of *normal currents*, i.e. currents with finite mass and finite mass of the boundary, can be useful as a non-smooth model of other classical objects; we will come back to normal currents later.

We can now go back to calibrations.

1.1.3 Calibrated currents

What played a role in (1.1)? The *comparison of the form with the Riemannian volume element* and the *closedness* of the form. Remark further that it is enough to have things defined just almost everywhere for the quantities to make sense and that Stokes theorem is just the definition of boundary for currents. So we can do things in much wider generality.

After Wirtinger, DeRham and Federer who observed complex behaviours, the key features of calibrations were used in in [7] and [14] for quaternionic ones. The general notion of calibration then appeared in [30].

Given a m -form ϕ on a Riemannian manifold (M, g) , the comass of ϕ is defined to be

$$\|\phi\|^* := \sup\{\langle \phi_x, \xi_x \rangle : x \in M, \xi_x \text{ is a unit simple } m\text{-vector at } x\}.$$

A form ϕ of comass one is called a **calibration** if it is closed ($d\phi = 0$). We will be dealing also with non-closed forms of unit comass, which will be referred to as **semi-calibrations**.

Let ϕ be a *calibration* or a *semi-calibration*; among the oriented m -dimensional planes that constitute the Grassmannians $G(m, T_x M)$, we pick those that (represented as unit simple m -vectors) realize $\langle \phi_x, \xi_x \rangle = 1$ and define the set $\mathcal{G}(\phi)$ of *m -planes calibrated by ϕ* :

$$\mathcal{G}(\phi) := \cup_{x \in M} \{ \xi_x \in G(m, T_x M) : \langle \phi_x, \xi_x \rangle = 1 \}.$$

In other words, these are exactly the m -planes on which ϕ agrees with the m -volume form.

For a current in $\mathcal{R}_m(M)$, at \mathcal{H}^m -almost every point $x \in \mathcal{C}$ denote by $T_x \mathcal{C}$ the m -dimensional oriented approximate *tangent plane* to the underlying rectifiable set \mathcal{C} ; given a (semi)-calibration ϕ , C is said to be *calibrated by ϕ* (or *ϕ -positive*) if

$$\text{for } \mathcal{H}^m\text{-almost every } x, \text{ sign}(\theta)T_x \mathcal{C} \in \mathcal{G}(\phi).$$

For currents the *mass* is defined by $M(C) := \sup\{C(\beta) : \|\beta\|^* \leq 1\}$ and in general this sup need not be achieved. Remark that the mass coincides with the standard m -dimensional volume if we are dealing with the current of integration on a m -dimensional submanifold. In the case of ϕ -(semi)-calibrated currents, however, it is indeed true that the sup in the definition of mass is achieved: namely when we test on ϕ itself. This yields the following very important facts.

When ϕ is a closed form, then a current calibrated by ϕ is locally homologically *volume-minimizing* as the following computation shows. Let T be calibrated by ϕ and let S be in the same homology class, i.e. $T - S = \partial C$ for a $(m + 1)$ -dimensional current. Then

$$M(T) = T(\phi) = C(d\phi) + S(\phi) = S(\phi) \leq M(S) \quad (1.2)$$

since ϕ has unit comass.

Semi-calibrated integral currents, on the other hand, are not generally minimizers: they are however *almost-minimizers*, or λ -minimizers (in the sense of [22]), since in the case $d\phi \neq 0$, (1.2) shows that (recall $T + \partial C = S$)

$$M(T) = T(\phi) = C(d\phi) + S(\phi) \leq M(S) + \lambda M(C) \quad (1.3)$$

with a constant $\lambda = \|d\phi\|^*$. So λ -minimizers allow an error term in the inequality (1.2).

1.1.4 Some interesting calibrations

Let us start with some “interesting” calibrations in \mathbb{R}^n . What makes a calibration interesting? Usually we would like the calibrating form to have plenty of calibrated submanifolds, or integral currents (see [30] or [34]). The following calibrations do so and were studied in [30].

- *Complex calibrations.* In \mathbb{R}^{2n} , with coordinates $(x_1, y_1, \dots, x_n, y_n)$, take the form

$$\omega = \sum_{j=1}^n dx^j \wedge dy^j.$$

This is the generalization of the example that we have seen in subsection 1.1.1. Calibrated currents are 2-dimensional and have the property that their tangents are complex lines, after identifying $\mathbb{R}^{2n} \cong \mathbb{C}^n$.

We can more generally take the $2m$ -form

$$\frac{1}{m!}(\omega)^m;$$

this is also a calibration (Wirtinger’s inequality) and calibrated integral currents have real dimension $2m$ and the property of having tangents that are complex subspaces.

- *Special Lagrangian calibration* In $\mathbb{C}^n \cong \mathbb{R}^{2n}$ with coordinates $z_j = x_j + iy_j$, $j = 1, \dots, n$ the n -form

$$\operatorname{Re}(dz^1 \wedge dz^2 \dots \wedge dz^n)$$

is closed and has unit comass (see [30]).

As an example, in $\mathbb{R}^6 \cong \mathbb{C}^3$ the form reads

$$dx^1 \wedge dx^2 \wedge dx^3 - dx^1 \wedge dy^2 \wedge dy^3 - dy^1 \wedge dx^2 \wedge dy^3 - dy^1 \wedge dy^2 \wedge dx^3.$$

- Other very interesting calibrations presented in [30] are the so-called *Associative calibration* and *Cayley calibration*.
- We mention the *Nance calibration*, used in a striking and elegant way in [45] to prove one direction of the famous *angle conjecture*, on the condition that makes a pair of m -disks in \mathbb{R}^N area-minimizing.

It is also remarkable that the other half of the conjecture, proved by Lawlor [38], also made use of a calibration, namely the Special Lagrangian one.

So far we have described calibrations in \mathbb{R}^n . Let us now move on to manifolds and observe some analogues of the previous examples.

Almost-complex geometry. We are on a symplectic manifold \mathcal{K}^{2n} of (real) dimension $2n$ with a symplectic form ω and an almost complex structure J .

Recall that the defining conditions for ω to be symplectic are the *closedness*, $d\omega = 0$, and the *non-degeneracy*, $\omega^n \neq 0$. An *almost complex* structure J is an endomorphism of the tangent bundle with the property that on any tangent space $J^2 = -Id$.

The compatibility condition required on the symplectic form ω and on the almost complex structure J relies in the fact that we can define a Riemannian metric g by setting $g(\cdot, \cdot) := \omega(\cdot, J\cdot)$. We will then endow $(\mathcal{K}^{2n}, \omega, J)$ with the metric g .

The form ω is then a calibration and currents calibrated by ω are 2-dimensional and are called *pseudo-holomorphic*. Their property is that their approximate tangent spaces are J -invariant.

It is of course possible to take normalized powers of the symplectic form as in the flat case of \mathbb{R}^n to get even-dimensional forms that are still calibrations: the comass notion is indeed pointwise and closedness of the powers is trivial.

We remark that it is not generally possible (even locally) to find complex coordinates such that J is induced by these coordinates. When that is the case, the almost-complex structure is called *integrable* and the manifold is called *Kähler*. But generally almost complex structures are *non-integrable*.

Special Lagrangian geometry. We are in a so-called Calabi-Yau n -fold (the real dimension is $2n$). These are Kähler manifolds with the following defining property: there exists a n -form Θ that is parallel and such that $\Theta \wedge \bar{\Theta} = c_n d\text{vol}_{2n}$, for some dimensional constant c_n . The form Θ is said to be of type $(n, 0)$.

The form $Re(\Theta)$ is a calibration and the n -dimensional calibrated currents are called Special Lagrangians.

1.2 Regularity questions

The symbolic cornerstone for Geometric Measure Theory is usually set at 1960 with the foundational paper [27] by Federer and Fleming; key features

of rectifiable currents had appeared shortly before in De Giorgi's works [17] and [18] on *sets of finite perimeter*.

As already mentioned, *integral currents* turned out to be, thanks to nice compactness properties, suitable for the study of Plateau's problem of finding a surface of minimal area spanning a given boundary.

Once existence of a minimizer is established, however, one is left with the (hard) question: *how smooth is the minimizer?*

The issue of regularity of the so called *minimizing currents* in codimension one, that is $(n - 1)$ -currents that solve Plateau's problem in \mathbb{R}^n , was brought to a conclusion in the late Sixties thanks to the contributions of Almgren [2], Simons [55], Bombieri, De Giorgi and Giusti [11]: the smoothness up to dimension 7 was proved, while in \mathbb{R}^8 the example of a minimizing cone with a point-singularity was provided.

The higher codimension case for the minimizing problem is much harder: the case of *holomorphic currents* was solved in the works of King [35] and Harvey-Schiffman [32] (later a different proof was given by Alexander, [1]), but for general minimizing currents for long time it was only known that the set of regular points had to be dense (see [25]); there was a sudden breakthrough with Almgren's Big Regularity Paper [2], where it was proved that the singular set has **codimension at most two** in the current. This proof is however long and hard (1000 pages), so that the topic is still of interest. Almgren's student Chang then improved the regularity result in the case of 2-dimensional minimizers ([12]), showing that the singular set in that case is made of isolated points; the proof relies however on [2].

Understanding the proof by Almgren introducing simplifications and new ideas was the goal of [15] and [16] and work there is still in progress.

On the other hand, it is helpful to have simpler proofs, independent of Almgren's monument, for some particular cases of minimizing currents in higher codimension, for example calibrated ones, both in \mathbb{R}^n or in a Riemannian manifold. Having such examples helps the understanding of the possible singular behaviour of such minimizers. The regularity of calibrated and semi-calibrated integral currents, however, also has deep impact on several geometric problems, some of which are overviewed in the next section.

The proofs in [35], [32] and [1] do not extend to the case of non-integrable almost complex structures. The *regularity for pseudo holomorphic cycles* of dimension 2 was proved in [58], [50], [51]: they can only have isolated point-singularities.

If we increase the dimension of the current, we find, among others, a very large class of calibrated currents, the so-called *Special Lagrangians*, described in the previous subsection. Since 2-dimensional Special Lagrangians turn out

to be, up to a change of variable, just pseudo-holomorphic (see [34]), the first difficult dimension to look at is that of 3-dimensional Special Lagrangians in a Calabi-Yau 3-fold.

1.3 Calibrations: beyond Plateau's problem

Some years ago, in a survey paper [21], S.K. Donaldson and R.P. Thomas gave a fresh boost to the analysis of non-linear *gauge theories* in geometry by exhibiting heuristically links between some **invariants in complex geometry** and spaces of **solutions to Yang-Mills** equations in dimensions higher than 4 (which is the usual conformal dimension for these equations).

Remark that doing theory of invariants typically requires perturbations to ensure transversality of spaces involved; this explains one of the needs to be able to handle non-flat structures: for example *almost-complex* manifolds, which are more flexible, rather than just complex ones.

It then became important to understand limiting behaviours of solutions to Yang-Mills. In [59] G. Tian described the loss of compactness of sequences of some *Yang-Mills Fields* in dimension larger than 4. This *loss of compactness* arises along $(n - 4)$ -rectifiable objects, called the **blow-up sets**.

Can one expect the blow-up set to be more than just rectifiable? What is its exact nature?

At such a level of generality this question is wide open and difficult. The situation is better understood for some sub-classes of solutions, namely Ω -anti-self-dual instantons, where blow-up sets naturally come endowed with the property of being calibrated. One example is given by the so-called *SU(4)-Instantons* in a Calabi-Yau 4-fold: among blow-up sets, in this case, we find *Special Lagrangian Integral Currents*.

In [59] we also find examples and conjectures regarding very general links between *invariants theory* and spaces of *solutions to equations*: in these examples a key role is played by a differential form of comass one. The conjectures extend even when dealing with non-closed forms (see final section of [59]). The topic is still very open and provides a lot of inspiration for the study of calibrated or semi-calibrated integral currents.

In 2000 Taubes [58] proved an impressive result, showing that the so-called **Seiberg-Witten invariants** in a 4-dimensional almost-complex manifold agree with certain **Gromov invariants**.

Seiberg-Witten invariants are defined by a suitable counting of solutions to a certain elliptic system. Gromov invariants, on the other hand, are defined by a suitable counting of (classical) pseudo-holomorphic curves in the

manifold.

The two notions, seemingly unrelated, yield the same invariants and the proof by Taubes, in the direction going from Seiberg-Witten to Gromov, makes a key use of the regularity result for pseudo-holomorphic cycles in dimension 4 ([58], [50]). Roughly speaking, starting from a sequence of solutions to Seiberg-Witten equations, Taubes observed the limiting behaviour of some level sets. These objects fulfil the compactness conditions for integral currents and therefore yield an integral cycle as limit. Hard estimates show that the limit must be calibrated by the symplectic form. Regularity of pseudo-holomorphic cycles then allows to view this cycle as a classical pseudo-holomorphic curve, thus getting a connection with Gromov invariants.

Further reasons for studying *Special Lagrangians* come from **String Theory**, more precisely from *Mirror Symmetry*. According to this model, our universe is a product of the standard Minkowsky space \mathbb{R}^4 with a Calabi-Yau 3-fold Y . Based on physical grounds, the so called *SYZ-conjecture* (named after Strominger, Yau and Zaslov) expects, roughly speaking, that this Calabi-Yau 3-fold can be fibrated by (possibly singular) Special Lagrangians, whence the interest in understanding the singularities of a *Special Lagrangian current*. The compactification of the *dual fibration* should lead to the mirror partner of Y . See the survey paper by Joyce [34] for a more thorough explanation.

1.4 Non-rectifiable currents

So far we have concentrated on integer multiplicity rectifiable currents. The notion of being *calibrated* extends however to non-rectifiable currents of finite mass, as we are about to explain. When the current is not rectifiable, we will refer to it as *positive* rather than calibrated (following [30]).

A m -current C in a manifold \mathcal{M} such that $M(C)$ and $M(\partial C)$ are finite is called a *normal current*. Any current C of finite mass is representable by integration (see [28] pages 125-126), i.e. there exist

- (i) a Radon measure $\|C\|$,
- (ii) a generalized tangent space $\vec{C}_x \in \Lambda_m(T_x \mathcal{M})$, that is defined for $\|C\|$ -a.a. points x , is $\|C\|$ -measurable and has² mass-norm 1,
such that the action of C on any m -form β with compact support is expressed as follows

²Recall that the mass-norm for m -vectors is defined in duality with the comass on two-forms. The unit ball for the mass-norm is the convex envelope of unit simple m -vectors.

$$C(\beta) = \int_{\mathcal{M}} \langle \beta, \vec{C} \rangle d\|C\|.$$

As usual, a current with zero boundary is shortly called a *cycle*. Given a (semi)calibration ϕ , we consider a ϕ -**positive** normal m -cycle T . Equivalent notions of ϕ -positiveness (see [30] or [31]) are

- $\vec{T} \in \text{convex hull of } \mathcal{G}(\phi) \quad \|T\| \text{-a.e.}$
- $\langle \phi, \vec{T} \rangle = 1 \quad \|T\| \text{-a.e.}$

The last condition is clearly equivalent to the important equality

$$T(\phi) = \int_{\mathcal{M}} \langle \phi, \vec{T} \rangle d\|T\| = M(T). \quad (1.4)$$

Remark that for arbitrary currents $M(C) := \sup\{C(\beta) : \|\beta\|^* \leq 1\}$ and in general this sup need not be achieved. Also remark that for currents of finite mass the action can be extended to smooth forms with non-compact support (actually to forms with merely bounded Borel coefficients, see [28] page 127). So $T(\phi)$ in (1.4) makes sense.

In the case when ϕ is closed, from (1.4), with the same argument as in (1.2) one gets again that a ϕ -positive T is (locally) homologically mass-minimizing, while for a non-closed ϕ the current T is locally an almost-minimizer of the mass.

A certain class of positive currents has been studied quite extensively, namely when the calibration is a Kähler form. These positive currents in \mathbb{C}^n are strongly related to pluri-subharmonic functions (see [39]) and most of the regularity results known for these currents rely on this connection.

On the other hand, if we turn our attention to almost complex manifold, there is no availability of pluri-subharmonic potentials and indeed a regularity theory for positive currents in an almost complex setting has not been yet developed. We will come back to these issues in section 1.5.3, where we also sketch some applications.

1.5 Results of this thesis

As remarked before, the first interesting dimension for Special Lagrangians, when thinking of regularity issues, is 3. Independently of Almgren, not much can be said for the moment about the smoothness of 3-dimensional Special Lagrangians.

It is a standard result that calibrated integral cycles possess tangent cones at all points (although they are known to be unique only if the current is of dimension 2, see [62], [47]). These tangent cones, that live in the tangent space of the manifold at the point under observation, are also calibrated, namely by the differential form at the point under observation.

In particular, tangent cones to 3-D Special Lagrangians are nothing else but cones in $\mathbb{R}^6 \cong \mathbb{C}^3$ calibrated by

$$\operatorname{Re}(dz^1 \wedge dz^2 \wedge dz^3)$$

(up to a suitable change of coordinates). These cones are the object of chapter 2, where we prove that they are **smooth except possibly at a finite number of lines** through the vertex. The result is optimal and improves the one yielded by Almgren's Big Regularity Paper. The contents of chapter 2 are the result of a joint work with Tristan Rivière ([4]).

The slice of such a cone with the sphere S^5 turns out to be an integral cycle of dimension 2 that is semi-calibrated by the two-form

$$\operatorname{Re}\left(\sum_{i=1}^3 z_i dz^{i+1} \wedge dz^{i+2}\right),$$

with the indexes understood *mod* 3. This two-form is called *Special Legendrian semi-calibration* and a semi-calibrated cycle is thus called *Special Legendrian*. The regularity of Special Lagrangian cones is then deduced from the main result of that chapter, saying that a Special Legendrian cycle can only have **isolated point singularities**. The word legendrian refers to the fact that such cycles are tangent to the standard contact distribution of S^5 (tangency is understood here almost everywhere on the cycle, so where the approximate tangent exists).

In subsection 1.5.1 an overview of the proof and a discussion of the difficulties are presented.

Chapter 3 is then devoted to the study of *semi-calibrated 2-dimensional integral legendrian cycles* in a contact manifold of dimension 5, thus generalizing the case of Special Legendrians in S^5 , where the geometric structures are extremely symmetric. The word legendrian again refers to the fact that for such cycles the approximate tangents lie in the horizontal (contact) distribution. Under quite generic assumptions we get again that such cycles can only have **isolated point singularities**. In subsection 1.5.2 we take a closer look at the setting.

In chapter 4 we turn our attention to non-rectifiable currents, as described in section 1.4. More precisely we will be dealing with *regularity properties*

at the infinitesimal level, namely with the uniqueness of tangent cones, for pseudo holomorphic normal cycles: so we exit the world of rectifiable currents, moving to more general objects. We postpone a more precise description of the problem and of the objects involved to section 1.5.3, where we also discuss possible applications.

1.5.1 Special Legendrian cycles in S^5 : overview

In \mathbb{C}^3 with the standard coordinates $z = (z_1, z_2, z_3)$, $z_i = x_i + iy_i$, consider the *Special Lagrangian calibration*

$$\Omega = \operatorname{Re}(dz^1 \wedge dz^2 \wedge dz^3).$$

We will be interested in Ω -calibrated integral cones with vertex at the origin, i.e. integral currents calibrated by Ω and invariant under the push-forward via homotheties: more precisely, a homothety about the origin is $x \rightarrow \lambda x$ for a positive λ , so the current C is a cone if $(\lambda x)_* C = C$ for any $\lambda > 0$.

Let N denote the radial vector field $N := r \frac{\partial}{\partial r}$ in \mathbb{C}^3 and define the *normal part* of Ω by

$$\Omega_N := \iota_N \Omega,$$

where ι denotes the interior product. We will work in the sphere $S^5 \subset \mathbb{C}^3$, with the induced metric. Consider the pull-back of Ω_N on the sphere via the canonical inclusion map $\mathcal{E} : S^5 \hookrightarrow \mathbb{C}^3$:

$$\omega := \mathcal{E}^* \Omega_N.$$

An easy computation shows that

$$\omega = \operatorname{Re}(z_1 dz^2 \wedge dz^3 + z_2 dz^3 \wedge dz^1 + z_3 dz^1 \wedge dz^2).$$

ω is a 2-form on S^5 of comass one. Indeed, $|N| = 1$ on S^5 and for any simple 2-vector ξ in TS^5

$$|\omega(\xi)| = |\Omega(N \wedge \xi)| \leq \|N \wedge \xi\| = \|\xi\|.$$

Equality is surely reached when $N \wedge \xi$ is a Special Lagrangian 3-plane, compare Proposition 1. We remark that both Ω and ω are $SU(3)$ -invariant. As explained in [30] (Section II.5) or [33] (Section 2.2), ω is non-closed. It can be checked that $d\omega = 3\mathcal{E}^*\Omega$.

ω is referred to as the *Special Legendrian semi-calibration*. Rectifiable currents in S^5 calibrated by ω are called *Special Legendrians*.

Our main result (joint work with Tristan Rivière, [4]) is the following:

Theorem 1.5.1. *An integer multiplicity rectifiable current C without boundary calibrated by ω (this is called a Special Legendrian integral cycle) in S^5 can only have isolated singularities, therefore finitely many.*

In other words: C is, out of isolated points, the current of integration along a smooth Special Legendrian submanifold with smooth integer multiplicity.

Remark 1.5.1. This result is optimal. We will provide an example later, see remark 2.1.2.

Still from [30] (Section II.5) or [33] (Section 2.2), the 2-currents of S^5 on which ω restricts to the area form are exactly those such that the cone built on them is calibrated by Ω :

Proposition 1. *([30] or [33]) A rectifiable current T in S^5 is a Special Legendrian if and only if the cone on T*

$$C(T) = \{tx \in \mathbb{R}^6 : x \in T, t > 0\}$$

is Special Lagrangian.

We know that Special Lagrangian currents (as a particular case of currents calibrated by a closed form) are (locally) homologically area-minimizing in \mathbb{C}^3 ; from [2] we know that volume-minimizing 3-cycles are smooth outside a set of Hausdorff dimension 1. In the case of a cone, this roughly translates into having radial lines of singularities, possibly accumulating onto each other. We establish here that there can only be a finite number of such lines.

Special Lagrangians in general *Calabi-Yau n -folds* are known to possess tangent cones at all points (see [30] sect. II.5), and such cones are Special Lagrangian cones in \mathbb{C}^n . Thanks to Proposition 1, our result can be restated as follows:

Corollary 1.5.1. *Tangent cones to a Special Lagrangian in a Calabi-Yau 3-fold have a singular set made of at most finitely many lines passing through the vertex.*

From [55] (Prop. 6.1.1), T in S^5 is minimal, in the sense of vanishing mean curvature, if and only if $C(T) \subset \mathbb{C}^3$ is minimal. Therefore, Special Legendrians are minimal in S^5 (although not necessarily area-minimizing).

Relying on [2], Chang proved in [12] the corresponding regularity result for area-minimizing 2-dimensional currents.

One advantage coming from the existence of the calibration, as will be seen, is the fact that the current can locally be described as integration along a multi-valued graph satisfying a first order elliptic PDE; the general problem

of volume-minimizing currents, instead, requires an elliptic problem of order two, see [2] or [12].

The proof. We will now give a sketch of our proof. The underlying structure is basically the same as in [58] and [50], where the regularity of J -holomorphic cycles in a 4-dimensional ambient manifold was shown. In our case we have a fifth coordinate to deal with, which introduces new challenging difficulties, as will be seen.

A standard blow-up analysis tells us that at any point x of S^5 the multiplicity function $\theta(x) = \lim_{r \rightarrow 0} \frac{M(C \llcorner B_r(x))}{\pi r^2}$ is³ an integer Q . The monotonicity formula (see [47] or [53]) tells us that, at any x_0 , $\frac{M(C \llcorner B_r(x_0))}{r^2}$ is monotonically non-increasing as $r \downarrow 0$, whence we get that θ is upper semi-continuous. Therefore the set

$$\mathcal{C}^{\leq Q} := \{x \in S^5 : \theta(x) \leq Q\}$$

is open in S^5 . This allows a proof by induction of our result: indeed, the statement of Theorem 3.0.2 is local, so we can restrict the current to $\mathcal{C}^{\leq Q}$ and consider increasing integers Q (see the beginning of section 2.4).

One key ingredient is the construction of families of 3-dimensional surfaces Σ which locally foliate S^5 and that have the property of intersecting positively the Special Legendrian ones. As in [50], this algebraic property can be exploited to provide a self-contained proof of the uniqueness of tangent cones for our current. This result was proved for general semi-calibrated cycles in [47] and for general area-minimizing ones in [62] using a completely different approach⁴.

³Precisely, for any point x_0 , denoting by B_r the geodesic ball of radius r , we have that $\frac{M(C \llcorner B_r(x_0))}{r^2} = R(r) + O(r)$ for a function R which is monotonically non-increasing as $r \downarrow 0$ and tends to the multiplicity at x_0 as $r \downarrow 0$, and a function $O(r)$ which is infinitesimal. The term $O(r)$ however does not affect the arguments and everything works as in the case of a purely monotone function. We will therefore speak of monotonicity formula, although the precise term would be *almost-monotonicity*. This result is proved in [47] and recalled in the appendix.

For general integral cycles, the limit $\lim_{r \rightarrow 0} \frac{M(C \llcorner B_r(x))}{\pi r^2}$ exists a.e. and coincides with the absolute value $|\theta|$ of the multiplicity assigned in the definition of integer cycle. In our case $\lim_{r \rightarrow 0} \frac{M(C \llcorner B_r(x))}{\pi r^2}$ is well-defined everywhere, therefore we can choose (everywhere) this natural representative for θ , after having chosen the correct orientation for the approximate tangent plane.

⁴The proof in [62] relies however on the area-minimality property which is not generally true for Special Legendrians.

Further, the positiveness of intersection allows us to describe our current, locally around a point x_0 of multiplicity Q , as a Q -valued graph from a disk $D^2 \subset \mathbb{C}$ into $\mathbb{R}^3 \cong \mathbb{C} \times \mathbb{R}$. This means that we associate to each $z \in D^2$ a Q -tuple of points in $\mathbb{C} \times \mathbb{R}$. The Q -tuple is to be understood as *unordered*, i.e. as an element of the Q -th symmetric product of $\mathbb{C} \times \mathbb{R}$. It is not possible to find, globally on D^2 , a coherent labeling of the multi-valued graph as a superposition of Q functions.

The transition *current* \rightarrow *multi-valued graph* is done by slicing the current with a “parallel family” of 3-surfaces Σ of the type mentioned above: one must choose a good “direction” for the slicing, namely take a Σ that is transverse to the tangent cone at x_0 . This ensures, locally around x_0 , the constancy of the intersection index when we move Σ “parallel to itself”. The intersection index, which counts intersections with signs, turns out to be constantly Q . But the sign of intersection is always positive, due to the property of the Σ ’s. This yields that the number of points at which the 3-surfaces cross the current is exactly Q , taking multiplicities into account.

Currents of integration along multivalued graphs constitute one of the important objects of interest in Geometric Measure Theory. Multivalued graphs were introduced by Almgren in [2] for the study of Dirichlet-minimizing and volume-minimizing currents and were lately revisited in a new flavour in [15].

As we said above, the proof of theorem 3.0.2 is done by induction on the multiplicity Q . Recall that by upper semi-continuity of the multiplicity, we already know that all points in a neighbourhood of a point of multiplicity Q have multiplicity no higher than Q . Therefore, the inductive step is divided into two parts: in the first one we show that there is no possibility for an accumulation of singularities of multiplicity Q to a singularity of the same multiplicity; in the second part we exclude accumulation of lower order singularities to a singularity of order Q .

First part of the inductive step. There is a situation in which, just by slicing techniques, it is possible to exclude the possibility that singular points of multiplicity Q accumulate onto a point x_0 of the same multiplicity. This case occurs when the tangent cone at x_0 is not made of Q times the same disk and will be referred to as easy case of non accumulation (see theorem 2.3.2).

The case of a point with a tangent made of the same disk counted Q times is considerably harder and leads to theorem 2.4.1. Let us therefore focus on this case and see an overview of the several steps.

We introduce the first order PDEs (for the Q -valued graph) that describe the calibrating condition. These equations turn out to be, in appropriate coordinates, perturbations of the classical Cauchy-Riemann equations, but

with three real functions and two real variables.

More precisely, we denote the Q -valued graph describing the current in a neighbourhood of a point of multiplicity Q by

$$\{(\varphi_j(z), \alpha_j(z))\}_{j=1\dots Q} \quad ,$$

where $z = x + iy$ is the coordinate in the Disk $D^2 \subset \mathbb{C}$, $\varphi_i \in \mathbb{C}$ and $\alpha_i \in \mathbb{R}$. Without loss of generality we can assume $(\varphi_j(0), \alpha_j(0)) = (0, 0)$ for all $j = 1, \dots, Q$, so that we are centered at the origin of $D^2 \times \mathbb{C} \times \mathbb{R}$.

The equations solved by the branches of $\{(\varphi_j(z), \alpha_j(z))\}$ are as follows:

$$\begin{cases} \partial_{\bar{z}}\varphi_j = \nu((\varphi_j, \alpha_j), z) \partial_z\varphi_j + \mu((\varphi_j, \alpha_j), z) \\ \nabla\alpha_j = h((\varphi_j, \alpha_j), z), \end{cases} \quad (1.5)$$

where ν and μ are smooth complex valued functions on \mathbb{R}^5 such that $\nu(0) = \mu(0) = 0$ and h is a smooth \mathbb{R}^2 -valued map on \mathbb{R}^5 .

It is remarkable that if we were dealing with a single (Sobolev) solution $\varphi : D^2 \subset \mathbb{C} \rightarrow \mathbb{C} \times \mathbb{R}$ of the system above, then the regularity question would be easily answered by elliptic theory, yielding that φ is C^∞ .

As soon as we have a multi-valued graph, even just 2-valued, singularities are actually allowed! Then we can restate theorem 3.0.2 by saying that a singular behaviour for a multi-valued graph solving the system above is possible at most at isolated points.

We stress here that in order to get a Q -valued graph solving the system above we need to perform a careful choice of coordinates. Since this choice will require a lot of work, we digress shortly on its importance.

With general coordinates, induced by a slicing with arbitrary 3-dimensional surfaces, we would, in a first instance, lose the property of positive intersection and not any longer get a Q -valued graph. We could only associate to each $z \in D^2$ a set of points $\{A_1(z), \dots, A_P(z), B_1(z), \dots, B_N(z)\}$ with $P, N \in \mathbb{N}$ changing with z . The only thing that would be independent of z would be the difference $P - N = Q$. The points A_i would be those where there is a positive intersection with the slicing surfaces, the B_i -s those where this intersection is negative.

In addition to this, a further difficulty would arise. Writing equations for this ‘‘algebraic’’ Q -valued graph, we would find a supercritical equation, as explained in [51]. In comparison with the system (1.5), we would have a dependence on $\nabla\varphi_j$ inside μ and ν . With such an equation, even for a single-valued graph, we could not perform bootstrapping in order to get regularity, and in our case of multiple values, the unique continuation argument (see below) would fail.

Let us go back to the proof. Using the PDEs (1.5) we prove a $W^{1,2}$ estimate for the average $(\tilde{\varphi}, \tilde{\alpha})$ of the branches of our multivalued graph. We remark here that we give a proof of the $W^{1,2}$ -estimate different than the one in [50], where the authors had the further hypothesis that *Sing C* was \mathcal{H}^2 -negligible (see theorem 2.4.2).

We make a key use of the so-called relative Lipschitz estimate (theorem 2.3.3 and corollary 2.4.1). This estimate tells us the following: taken a point x_0 of multiplicity Q whose tangent cone is made of Q times the same disk D_0 , if there is a sequence of points $\{y_n\}$ of multiplicity Q accumulating onto x_0 then the tangent cones at the points y_n must flatten towards D_0 as $n \rightarrow \infty$ (see figure 2.6).

The $W^{1,2}$ -regularity of the average allows us to translate the issue of accumulation of singularities of multiplicity Q into a problem of accumulation of zeros for a new Q -valued graph solving a PDEs system - equations (2.41) and (2.42), that is again a perturbation of the classical Cauchy-Riemann. The new multi-valued graph, described by (2.40), is obtained from the original one by subtracting the average, as illustrated in figure 2.7. The $W^{1,2}$ -regularity of the average is the minimum regularity required in order to get that the new Q -valued graph (2.40) still represents a boundaryless current in $D^2 \times \mathbb{C} \times \mathbb{R}$: this fact is crucial later for the essential integration by parts formulae (see lemma 2.4.5).

Then by a suitable adaptation of the unique continuation argument used in [58], we prove that the multi-valued graph (2.40) obtained by subtracting the average from each branch cannot have accumulating zeros, thereby concluding the first part of the inductive step. The proof is by contradiction. The argument requires a further modification of the multi-valued graph (see (2.43) and (2.45)): this trick allows to “focus attention” on an accumulating sequence of zeros. In order to get a L^∞ -bound for this multi-valued graph (2.45) we need the Lipschitz-type estimate of corollary 2.4.1. Then we can use the partial integration allowed by lemma 2.4.5 and get a contradiction thanks to the elliptic nature of the equations (2.46) and (2.47) satisfied by the multi-valued graph.

The techniques we employ to show the partial integration formulae for multi-valued graphs are more typical of geometric measure theory; we also provide in lemma 2.4.5 a step that was incomplete in [58].

Second part of the inductive step. Let x_0 be a point of multiplicity Q such that, in a neighbourhood $B_r(x_0)$, the current C is smooth except at points of multiplicity $\leq Q - 1$ that are isolated in $B_r(x_0) \setminus \{x_0\}$ (this is what we have from the inductive assumption and from the first part of the inductive step). Then we aim to prove that it is not possible to have a

sequence of such isolated singularities of multiplicity $\leq Q - 1$ accumulating onto x_0 (this is the content of theorem 2.5.1).

We use an homological argument inspired by the one used in [58], where the same statement was proved in the case of J -holomorphic cycles in a 4-manifold, although in our case the existence of the fifth coordinate induces new difficulties and a more involved argument.

For the moment we just sketch the underlying idea, warning the reader that in section 2.5 the formal proof will require new spaces and functions, different from those sketched here, and some delicate estimates.

As above, we denote the Q -valued graph describing the current in a neighbourhood of a singular point x_0 of multiplicity Q by

$$\{(\varphi_j(z), \alpha_j(z))\}_{j=1 \dots Q} \quad ,$$

and denote $\pi : D^2 \times \mathbb{C} \times \mathbb{R} \rightarrow D^2$ the projection map. There is no loss of generality in taking $x_0 = 0$, the origin of $D^2 \times \mathbb{C} \times \mathbb{R}$. We assume (inductive assumption + first part of the inductive step) that the multi-valued graph is smooth except at 0 and at a sequence of points (different from 0) having multiplicity $\leq Q - 1$, isolated in $D^2 \times \mathbb{C} \times \mathbb{R}$ and accumulating to x_0 (so we are arguing by contradiction to prove theorem 2.5.1). Denote the projection onto D^2 of this sequence by $\{z_j\}$.

Roughly speaking, we would like to exhibit a continuous function $u : D^2 \rightarrow \mathbb{C}$, vanishing exactly on the set $\pi(\text{Sing } C) = \{0, z_1, \dots, z_j, \dots\}$, such that when we observe $\frac{u}{|u|}$ on positively oriented loops in $D^2 \setminus \pi(\text{Sing } C)$ the following hold:

- (i) if the loop γ encloses a point z_j then the topological degree of $\frac{u}{|u|} : \gamma \rightarrow S^1$ on that loop is strictly positive;
- (ii) for any loop $\gamma_r = \partial B_r(0)$ around the origin, the degree of $\frac{u}{|u|} : \gamma_r \rightarrow S^1$ is bounded from below by a constant $k \in \mathbb{Z}$ independent of r .

From these properties we could conclude theorem 2.5.1 by the following homotopy argument.

Take any loop $\gamma_{r_1} = \partial B_{r_1}(0)$ lying in $D^2 \setminus \pi(\text{Sing } C)$ and look at the integer $\deg\left(\frac{u}{|u|}, \gamma_{r_1}\right)$, the degree of $\frac{u}{|u|} : \gamma_{r_1} \rightarrow S^1$. Say it is 1000.

Inside $B_{r_1}(0)$ we can choose $\gamma_{r_2} = \partial B_{r_2}(0)$ lying in $D^2 \setminus \pi(\text{Sing } C)$ so that in the annulus $B_{r_1}(0) \setminus \overline{B_{r_2}(0)}$ there are $1001 + k$ of the points z_j . This is possible by the contradiction assumption of actually having a sequence converging to 0. Around each such z_l take an oriented loop γ_l which encloses exactly one of them. We can of course ensure that each γ_l lies in the annulus

and does not meet $\pi(\text{Sing } C)$. We know from (i) that $\deg\left(\frac{u}{|u|}, \gamma_l\right) \geq 1$ for all l .

By homotopy, since $\frac{u}{|u|}$ is continuous on $D^2 \setminus \pi(\text{Sing } C) = \{u \neq 0\}$, we have

$$\deg\left(\frac{u}{|u|}, \gamma_{r_1}\right) = \deg\left(\frac{u}{|u|}, \gamma_{r_2}\right) + \sum_l \deg\left(\frac{u}{|u|}, \gamma_l\right),$$

where the summation is taken over the $1001 + k$ loops γ_l in the annulus. Each term in this summation is ≥ 1 . From this we get $\deg\left(\frac{u}{|u|}, \gamma_{r_2}\right) \leq k - 1$, contradicting (ii).

This is also the idea in [58]. In that work, the function u is defined by observing the *relative difference* of points having the same projection on D^2 : this is naturally an element of \mathbb{C} in that case.

But for our Special Legendrian, the relative difference naturally lives in $\mathbb{C} \times \mathbb{R}$ (see figure 2.8), and there is no notion of degree for a function $u : D^2 \rightarrow \mathbb{C} \times \mathbb{R}$, therefore we need to change the setting. We will introduce a new space, modelled on the product of the 2-dimensional current with \mathbb{R} and define a function u from this product into $\mathbb{C} \times \mathbb{R}$; this function mimics the *relative difference* and that allows a homological argument.

Close enough to each isolated singularity, the \mathbb{C} -component of the *relative difference* encloses all the topological information and we can neglect the \mathbb{R} -component (see lemmas 2.5.2 and 2.5.3). Unfortunately this is only possible very close to each isolated singularity, and we need to take care also of the \mathbb{R} -component when we seek a global estimate from below (obtained in lemma 2.5.5) analogous to the one in (ii), whence the somewhat curious choice of u and of its domain.

1.5.2 Semi-calibrated legendrians in a contact 5-manifold

Are there more general structures hidden behind the particular case of Special Legendrians in S^5 ? The situation there is extremely symmetric and indeed we can answer this question positively by showing a very natural framework, in which a similar regularity analysis can be performed.

Let $\mathcal{M} = \mathcal{M}^5$ be a five-dimensional manifold endowed with a contact structure⁵ defined by a one-form α that satisfies everywhere

$$\alpha \wedge (d\alpha)^2 \neq 0. \tag{1.6}$$

Remark that the existence of a contact structure implies the orientability of \mathcal{M} . We will assume \mathcal{M} oriented by the top-dimensional form $\alpha \wedge (d\alpha)^2$.

⁵For a broader exposition on contact geometry, the reader may consult [8] or [41].

Condition (1.6) means that the horizontal distribution H of 4-dimensional hyperplanes $\{H_p\}_{p \in M}$ defined by

$$H_p := \text{Ker } \alpha_p \quad (1.7)$$

is “as far as possible” from being integrable. The integral submanifolds of maximal dimension for the contact structure are of dimension two and are called *Legendrians*.

Given a contact structure, there is a unique vector field, called the Reeb vector field R_α (or vertical vector field), that satisfies $\alpha(R_\alpha) = 1$ and $\iota_{R_\alpha} d\alpha = 0$.

An almost-complex structure on the horizontal distribution is an endomorphism J of the horizontal sub-bundle which satisfies $J^2 = -Id$. Given a horizontal, non-degenerate two-form β , i.e. a two-form such that $\iota_{R_\alpha} \beta = 0$ and $\beta \wedge \beta \neq 0$, we say that an almost-complex structure J is compatible with β if the following conditions are satisfied:

$$\beta(v, w) = \beta(Jv, Jw), \quad \beta(v, Jv) > 0 \quad \text{for any } v, w \in H. \quad (1.8)$$

In this situation, we can define an associated Riemannian metric $g_{J,\beta}$ on the horizontal sub-bundle by setting

$$g_{J,\beta}(v, w) := \beta(v, Jw).$$

We can extend an almost-complex structure J defined on the horizontal distribution, to an endomorphism of the tangent bundle $T\mathcal{M}$ by setting

$$J(R_\alpha) = 0. \quad (1.9)$$

Then it holds $J^2 = -Id + R_\alpha \otimes \alpha$.

With this in mind, extend the metric to a Riemannian metric on the tangent bundle by

$$g := g_{J,\beta} + \alpha \otimes \alpha. \quad (1.10)$$

This extensions will often be implicitly assumed. Remark that R_α is orthogonal to the hyperplanes H for the metric g :

$$g(R_\alpha, X) = \beta(R_\alpha, JX) + \alpha(R_\alpha)\alpha(X) = 0 \quad \text{for } X \in H = \text{Ker } \alpha. \quad (1.11)$$

Example: We describe the *standard contact structure* on \mathbb{R}^5 . Using coordinates (x_1, y_1, x_2, y_2, t) the standard contact form is $\zeta = dt - (y_1 dx^1 + y_2 dx^2)$.

The expression for $d\zeta$ is $dx^1dy^1 + dx^2dy^2$ and the horizontal distribution is given by

$$\text{Ker } \zeta = \text{Span}\{\partial_{x_1} + y_1\partial_t, \partial_{x_2} + y_2\partial_t, \partial_{y_1}, \partial_{y_2}\}. \quad (1.12)$$

The standard almost complex structure I compatible with $d\zeta$ is the endomorphism

$$\begin{cases} I(\partial_{x_i} + y_i\partial_t) = \partial_{y_i} \\ I(\partial_{y_i}) = -(\partial_{x_i} + y_i\partial_t) \end{cases} \quad i \in \{1, 2\}. \quad (1.13)$$

I and $d\zeta$ induce, as described above, the metric $g_\zeta := d\zeta(\cdot, I\cdot) + \alpha(\cdot)\alpha(\cdot)$ for which the hyperplanes $\text{Ker } \zeta$ are orthogonal to the t -coordinate lines, which are the integral curves of the Reeb vector field.

We will be interested in two-dimensional Legendrians that are invariant for suitable almost complex structures defined on the horizontal distribution. What we require for an almost-complex structure J on the horizontal subbundle is the following **Lagrangian condition**

$$d\alpha(Jv, v) = 0 \quad \text{for any } v \in H. \quad (1.14)$$

This requirement amounts to asking that any J -invariant 2-plane must be Lagrangian for the symplectic form $d\alpha$, i.e. that $d\alpha$ vanishes on it identically. It also turns out to be equivalent to the following **anti-compatibility condition** (see chapter 3)

$$d\alpha(v, w) = -d\alpha(Jv, Jw) \quad \text{for any } v, w \in H. \quad (1.15)$$

The main result we present (also see [5]) is the following

Theorem 1.5.2. *Let \mathcal{M} be a five-dimensional manifold endowed with a contact form α and let J be an almost-complex structure defined on the horizontal distribution $H = \text{Ker } \alpha$, such that $d\alpha(Jv, v) = 0$ for any $v \in H$.*

Let C be an integer multiplicity rectifiable cycle of dimension 2 in \mathcal{M} such that \mathcal{H}^2 -a.e. the approximate tangent plane $T_x C$ is J -invariant⁶.

Then C is, except possibly at isolated points, the current of integration along a smooth two-dimensional Legendrian curve.

⁶Representing a 2-plane as a simple 2-vector $v \wedge w$, the condition of J -invariance means $v \wedge w = Jv \wedge Jw$. With (3.3) in mind, we see that a J -invariant 2-plane must be tangent to the horizontal distribution.

In **proposition 4** of chapter 3 we describe a direct application of this theorem to semi-calibrations. The cycles of proposition 4 are generally *almost-minimizers* (also called λ -*minimizers*) of the area functional: in section 3.3 we will see some cases when they are also *minimal*, in the sense of vanishing mean curvature.

The key ingredient that we need for the proof of theorem 3.0.2 is the construction of families of 3-dimensional surfaces⁷ which locally foliate the 5-dimensional ambient manifold and that have the property of **intersecting positively** the Legendrian, J -invariant cycles. In chapter 2, due to the fact that we are dealing with an explicit semi-calibration in a very symmetric situation, the 3-dimensional surfaces can be explicitly exhibited (see section 2.1). Here we will achieve this by solving, via fixed point theorem, a perturbation of Laplace's equation. After having done this, the proof can be completed by following that in chapter 2 verbatim.

The same idea was present in [50], where, in an almost complex 4-manifold, the authors produced J -holomorphic foliations by solving a perturbed Cauchy-Riemann equation. In our case the equation turns out to be of second order and, in order to prove the existence of a solution, we need to work in adapted coordinates (see proposition 5 in chapter 3 and the discussion that precedes it).

As already discussed in subsection 1.5.1, the existence of foliations that intersect positively a calibrated cycle fails in general and the lack of such foliations can make the regularity issue considerably harder: in particular the description of the current as a multiple valued graph fails and the PDE describing the current can become supercritical (see [51] for details).

Positive foliations are typical of "pseudo-holomorphic behaviours" in low dimensions; they exist in dimension 4 (see [58] and [50]) and in chapter 3 we show that this is the case also in dimension 5 under the mildest possible assumptions.

1.5.3 Positive $(1, 1)$ -normal cycles: tangent cones.

We turn now to non-rectifiable currents, with an overview of the results presented in chapter 4.

Normal currents in complex manifolds, positive with respect to the normalized powers of the Kähler form, have been studied quite extensively, since the work of Lelong [39]: they appeared at first in relation with the study of

⁷This existence result is where (3.8) and (3.9) play a determinant role.

plurisubharmonic functions and with integration on analytic varieties. Striking results, some of which we will now recall, have been obtained since then. For a reason that we will explain, 2-currents that are positive with respect to the Kähler form are also called positive $(1, 1)$ -currents.

For any positive $(1, 1)$ -current of finite mass and without boundary (a common term for that is *positive $(1, 1)$ -normal cycle*) in a complex manifold, the set of points with strictly positive Lelong number has a very regular structure: this set is a union of algebraic varieties, as shown by Y.-T. Siu in [56]: these varieties are holomorphic outside of possible singular points.

Such a “structure theorem” only holds, however, for the set of points with strictly positive Lelong number: there is no analogous representation for the global current. Indeed, two different positive $(1, 1)$ -cycles of finite mass can coincide on an open set but not globally, as shown in example 1.5.1. This lack of unique continuation allowed C. O. Kiselman in [36] to produce counterexamples to the *uniqueness of tangent cones* at an arbitrary point of a positive $(1, 1)$ -normal cycle.

Siu’s result implies that this failure can only happen at a point x_0 where there exists $\delta > 0$ so that the Lelong number ν fulfils $\nu(x_0) \geq \nu(x) + \delta$ for all points x in a neighbourhood of x_0 .

If we turn to an almost complex manifold and consider positive $(1, 1)$ -currents with respect to a possibly non-integrable almost complex structure J , the structure of the set of points with positive Lelong number has not been investigated much. The approach in the case of complex manifolds relies a lot on a connection with plurisubharmonic functions, not available in an almost complex manifold; due to the loss of such a tool, the strategy for a “structure theorem” (analogous to [56]) in the almost complex setting would require the use of totally different approaches and techniques. The need for such a result comes from several possible applications in geometry, namely problems where the structure must be perturbed from a complex to almost complex one, in order to ensure some transversality conditions (in the spirit of what was said in section 1.3). Related discussions can be found in [21], [50], [58], [59], [60]. An inspiring example is the one given in the last section of [59]. Later in this section we will sketch some explicit applications of such a “structure theorem”.

With this aim in mind we will prove a uniqueness theorem for tangent cones to $(1, 1)$ -normal cycles in an arbitrary almost complex manifold at non-isolated points of positive density. Before stating the result, we describe in a more detailed way the setting and recall the basic notions.

Let (\mathcal{M}, J) be a smooth almost complex manifold of dimension $2n + 2$ (with $n \in \mathbb{N}^*$), endowed with a non-degenerate 2-form ω compatible with J .

If $d\omega = 0$ then we have a symplectic form, but we will not need to assume closedness. Let g be the associated Riemannian metric, $g(\cdot, \cdot) := \omega(\cdot, J\cdot)$.

The form ω is a semi-calibration on \mathcal{M} for the metric g ; let $\mathcal{G}(\omega)$ be the set of 2-planes calibrated by ω .

The condition of being calibrated has an useful equivalent formulation: a 2-plane is in \mathcal{G}_x if and only if it is J_x -invariant or, in other words, if and only if it is J_x -holomorphic.

So an equivalent way to express ω -positiveness (defined in section 1.4) is that $\|T\|$ -a.e. \vec{T} belongs to the convex hull of J -holomorphic simple unit 2-vectors, in particular \vec{T} itself is J -invariant. For this reason ω -positive normal cycles are also called positive $(1, 1)$ -normal cycles⁸. Remarkably the $(1, 1)$ -condition only depends on J , so a positive $(1, 1)$ -cycle is ω -positive for any J -compatible couple (ω, g) .

Positive cycles (see [30] and [47]) satisfy an important *almost monotonicity property*: at any point x_0 the mass ratio $\frac{M(T \llcorner B_r(x_0))}{\pi r^2}$ is an almost-increasing function of r , i.e. it can be expressed as a weakly increasing function of r plus an infinitesimal of r . The precise statement can be found in section 4.1.

Monotonicity yields a well-defined limit

$$\nu(x_0) := \lim_{r \rightarrow 0} \frac{M(T \llcorner B_r(x_0))}{\pi r^2}.$$

This is called the (two-dimensional) **density** of the current T at the point x_0 (*Lelong number* in the classical literature, see [39]). The almost monotonicity property also yields that the density is an upper semi-continuous function.

Consider a dilation of T around x_0 of factor r which, in normal coordinates around x_0 , is expressed by the push-forward of T under the action of the map $\frac{x - x_0}{r}$:

$$(T_{x_0, r} \llcorner B_1)(\psi) := \left[\left(\frac{x - x_0}{r} \right)_* T \right] (\chi_{B_1} \psi) = T \left(\chi_{B_r(x_0)} \left(\frac{x - x_0}{r} \right)^* \psi \right). \quad (1.16)$$

⁸We are using the term *dimension* for a current as it is customary in Geometric Measure Theory, i.e. the dimension of a current is the degree of the forms it acts on. Remark that in the classical works on positive currents and plurisubharmonic functions, e.g. [39] or [56], our 2-cycle in \mathbb{C}^{n+1} would mostly be called a current of bidimension $(1, 1)$ and bidegree (n, n) .

The fact that $\frac{M(T \llcorner B_r(x_0))}{r^2}$ is monotonically almost-decreasing as $r \downarrow 0$ gives that, for $r \leq r_0$ (for a small enough r_0), we are dealing with a family of currents $\{T_{x_0,r} \llcorner B_1\}$ that satisfy the hypothesis of Federer-Fleming's compactness theorem (see [28] page 141). Thus there exist a sequence $r_n \rightarrow 0$ and a rectifiable boundaryless current T_∞ such that

$$T_{x_0,r_n} \llcorner B_1 \rightarrow T_\infty.$$

This procedure is called the *blow up limit* and the idea goes back to De Giorgi [17]. Any such limit T_∞ turns out to be a cone (a so called **tangent cone** to T at x_0) with density at the origin the same as the density of T at x_0 . Moreover T_∞ is ω_{x_0} -positive (see [30]).

The main issue regarding tangent cones is whether the limit T_∞ depends or not on the sequence $r_n \downarrow 0$ yielded by the compactness theorem, i.e. whether T_∞ is **unique or not**. It is not hard to check that any two sequences $r_n \rightarrow 0$ and $\rho_n \rightarrow 0$ fulfilling $a \leq \frac{r_n}{\rho_n} \leq b$ for $a, b > 0$ must yield the same tangent cone, so non-uniqueness can arise for sequences with different asymptotic behaviours.

The fact that a current possesses a unique tangent cone is a symptom of regularity, roughly speaking of regularity at infinitesimal level. It is generally expected that currents minimizing (or almost-minimizing) functionals such as the mass should have fairly good regularity properties. This issues are however hard in general.

The uniqueness of tangent cones is known for some particular classes of integral currents, namely for mass-minimizing integral cycles of dimension 2 ([62]) and for general semi-calibrated integral 2-cycles ([47]). In some other cases, which also follow from either of the forementioned [62] or [47], the proof has been achieved using techniques of positive intersection, namely for integral pseudo-holomorphic cycles in dimension 4 ([58], [50]) and for integral Special Legendrian cycles in dimension 5 (this thesis, chapters 2 and 3, i.e. [4], [8]). In [51] the uniqueness for pseudo holomorphic integral 2-dimensional cycles is achieved in arbitrary codimension. In [54] it is proved that if a tangent cone to a minimal integral current has multiplicity one and has an isolated singularity, then it is unique.

Passing normal currents, things get harder. Many examples of ω -positive normal 2-cycles can be given by taking a family of pseudoholomorphic curves and assigning a positive Radon measure on it (this can be made rigorous). However ω -positive normal 2-cycles need not be necessarily of this form, as the following example shows.

Example 1.5.1. In $\mathbb{R}^4 \cong \mathbb{C}^2$, with the standard complex structure, consider the unit sphere S^3 and the standard contact form γ on it.

The 2-dimensional current C_1 supported in S^3 and dual to γ , i.e. defined by $C_1(\beta) := \int_{S^3} \gamma \wedge \beta \, d\mathcal{H}^3$, is positive-(1,1) and its boundary is given by $\partial C_1(\alpha) := \int_{S^3} d\gamma \wedge \alpha \, d\mathcal{H}^3$, i.e. the boundary is the 1-current given by the uniform Hausdorff measure on S^3 and the Reeb vector field.

Now consider the positive (1,1)-cone C with vertex at the origin, obtained by assigning the uniform measure $\frac{1}{4\pi}\mathcal{H}^2$ on $\mathbb{C}\mathbb{P}^1$, i.e. C is obtained by taking the family of holomorphic disks through the origin and endowing it with a uniform measure of total mass 1. The current $C_2 := C \llcorner (\mathbb{R}^4 \setminus B_1^4(0))$ has boundary $\partial C_2 = -\partial C_1$, therefore $C_1 + C_2$ is a positive (1,1) cycle.

This construction shows that a ω -positive normal 2-cycle T is not very rigid and it is not true that, restricting for example to a ball B , the current $T \llcorner B$ is the unique minimizer for its boundary (which is instead true for integral cycles). This can be interpreted as a *lack of unique continuation* for these currents.

This issue reflects into the fact that the uniqueness of tangent cones to ω -positive normal 2-cycles **fails** in general, already in the case of the complex manifold (\mathbb{C}^n, J_0) , where J_0 is the standard complex structure: this was proven by Kiselman [36]. Further works extended the result to arbitrary dimension and codimension (see [9] and [10], where conditions on the rate of convergence of the mass ratio are given, under which uniqueness holds).

While in the integrable case (\mathbb{C}^n, J_0) positive cycles have been studied quite extensively, there are no results available for (1,1) cycles when the structure J is *almost complex*.

In chapter 4 (see also [6]) we prove the following result:

Theorem 1.5.3. *Given an almost complex $(2n + 2)$ -dimensional manifold $(\mathcal{M}, J, \omega, g)$ as above, let T be a positive (1,1)-normal cycle, i.e. a ω -positive normal 2-cycle.*

Let x_0 be a point of positive density $\nu(x_0) > 0$ and assume that there is a sequence $x_m \rightarrow x_0$ of points $x_m \neq x_0$ all having positive densities $\nu(x_m)$ and such that $\nu(x_m) \rightarrow \nu(x_0)$.

Then the tangent cone at x_0 is unique and is given by $\nu(x_0)[[D]]$ for a certain J_{x_0} -invariant disk D .

The notation $[[D]]$ stands for the current of integration on D . Our proof actually yields the stronger result stated in theorem 4.1.1.

In the integrable case Siu's work [56] gives us a strong and beautiful "structure" theorem, which in our situation states the following: given $c > 0$,

the set of points of a $(1, 1)$ -positive cycle of density $\geq c$ is made of analytic varieties each carrying a positive, real, constant multiplicity. Therefore, in the integrable case, theorem 1.5.3 follows from Siu's result.

In the non-integrable case, on the other hand, there are no regularity results available at the moment. The proofs of Siu's theorem given in the integrable case, see [56], [37], [40], [20], strongly rely on a connection with a plurisubharmonic potential for the current, which is not available in the almost complex setting.

In addition to the interest for tangent cones themselves, theorem 1.5.3 (and its extension 4.1.1) might serve as a first step towards a regularity result analogous to the one in [56], this time in the non-integrable setting.

Such a regularity result could be used for example in the study of pseudoholomorphic maps into algebraic varieties, as those analyzed in [50]. Indeed, if $u : M^4 \rightarrow \mathbb{C}\mathbb{P}^1$ is pseudoholomorphic and weakly approximable as in [50], with M^4 a compact closed 4-dimensional almost-complex manifold, denoting by ϖ the symplectic form on $\mathbb{C}\mathbb{P}^1$, then the 2-current U defined by $U(\beta) := \int_{M^4} u^* \varpi \wedge \beta$ is a positive normal $(1, 1)$ -cycle in M^4 . As explained in [50], the singular set of u is of zero \mathcal{H}^2 -measure and is located where the density of U is $\geq \epsilon$, for a positive ϵ depending on M^4 (this is a so-called ϵ -regularity result, see [52]). Then we would be reduced, in order to understand singularities of u , to the study of points of density $\geq \epsilon$ of U . Knowing that such a set is made of pseudoholomorphic varieties, together with the fact that it is \mathcal{H}^2 -null, would imply that the singular set is made of isolated points, the same result achieved in [50] with different techniques.

The strategy might then be applied to other dimensions. Normal $(1, 1)$ -cycles might also serve as a model case for other kind of problems, in which ϵ -regularity results play a role, for example Yang-Mills fields (see [59] and [60]).

We have been speaking of positive $(1, 1)$ -normal cycles in an almost complex manifold. As a side remark, observe that Special Legendrian currents in a 5-dimensional manifold \mathcal{M}^5 (rectifiable or not), actually fit in the context of this chapter. Indeed, we can take the product $\mathcal{M}^5 \times \mathbb{R}$ and easily extend the almost complex structure J , for which Special Legendrians are pseudo-holomorphic, to an almost complex structure J in $\mathcal{M}^5 \times \mathbb{R}$. Now we are in the hypothesis of chapter 4. In general the almost complex manifold $\mathcal{M}^5 \times \mathbb{R}$ will not admit a closed symplectic form that tames J , but just a non-closed one.

Sketch of the proof. The key idea for the proof of our result is to realize for our current a sort of “*algebraic blow up*”.

This is a well-known construction in Algebraic and Symplectic Geometry, with the name “*blow up*”. Since we have already introduced the notion of blow up as limit of dilations, as customary in Geometric Measure Theory, to avoid confusion we will call it *algebraic blow up*. We briefly recall how it goes in the complex setting (see figure 4.2).

Algebraic blow up (or *proper transform*), (see [41]). Define $\tilde{\mathbb{C}}^{n+1}$ to be the submanifold of $\mathbb{C}\mathbb{P}^n \times \mathbb{C}^{n+1}$ made of the pairs $(\ell, (z_0, \dots, z_n))$ such that $(z_0, \dots, z_n) \in \ell$.

$\tilde{\mathbb{C}}^{n+1}$ is a complex submanifold and inherits from $\mathbb{C}\mathbb{P}^n \times \mathbb{C}^{n+1}$ the standard complex structure, which we denote I_0 . The metric \mathbf{g}_0 on $\tilde{\mathbb{C}}^{n+1}$ is inherited from the ambient $\mathbb{C}\mathbb{P}^n \times \mathbb{C}^{n+1}$, that is endowed with the product of the Fubini-Study metric on $\mathbb{C}\mathbb{P}^n$ and of the flat metric on \mathbb{C}^{n+1} . Let $\Phi : \tilde{\mathbb{C}}^{n+1} \rightarrow \mathbb{C}^{n+1}$ be the projection map $(\ell, (z_0, \dots, z_n)) \rightarrow (z_0, \dots, z_n)$. Φ is holomorphic for the standard complex structures J_0 on \mathbb{C}^{n+1} and I_0 on $\tilde{\mathbb{C}}^{n+1}$ and is a diffeomorphism between $\tilde{\mathbb{C}}^{n+1} \setminus (\mathbb{C}\mathbb{P}^n \times \{0\})$ and $\mathbb{C}^{n+1} \setminus \{0\}$. Moreover the inverse image of $\{0\}$ is $\mathbb{C}\mathbb{P}^n \times \{0\}$.

$\tilde{\mathbb{C}}^{n+1}$ is a complex line bundle on $\mathbb{C}\mathbb{P}^n$ but we will later view it as an orientable manifold of (real) dimension $2n + 2$. The transformation Φ^{-1} (called *proper transform*) sends the point $0 \neq (z_0, \dots, z_n) \in \mathbb{C}^{n+1}$ to the point $([z_0, \dots, z_n], (z_0, \dots, z_n)) \in \tilde{\mathbb{C}}^{n+1} \subset \mathbb{C}\mathbb{P}^n \times \mathbb{C}^{n+1}$. With the almost complex structures J_0 and I_0 , the J_0 -holomorphic planes through the origin are sent to the fibers of the line bundle, which are I_0 -holomorphic planes.

Outline of the argument. We have a positive $(1, 1)$ -normal cycle T in \mathbb{C}^{n+1} , at the moment with reference to the standard complex structure J_0 , and we want to understand the tangent cones at the origin, that we assume to be a point of density 1. By assumption we have a sequence of points $x_m \rightarrow 0$ with densities converging to 1. Take a subsequence x_{m_k} such that $\frac{x_{m_k}}{|x_{m_k}|} \rightarrow y$ for a point $y \in \partial B_1$.

We can make sense (section 4.3) of the proper transform $(\Phi^{-1})_* T$, although the map Φ^{-1} degenerates at the origin, and prove that $(\Phi^{-1})_* T$ is a positive $(1, 1)$ -normal cycle in $(\tilde{\mathbb{C}}^{n+1}, I_0, \mathbf{g}_0)$.

The densities of points different than the origin are preserved under the proper transform (see the appendix), therefore the current $(\Phi^{-1})_* T$ has a sequence of points converging to a certain y_0 (that lives in $\mathbb{C}\mathbb{P}^n \times \{0\} \subset \tilde{\mathbb{C}}^{n+1}$) and the densities of these points converge to 1. More precisely $y_0 = H(y)$, where $H : S^{2n+1} \rightarrow \mathbb{C}\mathbb{P}^n$ is the Hopf projection.

$(\Phi^{-1})_* T$ is a positive $(1, 1)$ -cycle in $(\tilde{\mathbb{C}}^{n+1}, I_0, \mathbf{g}_0)$, so by upper semi-continuity of the density y_0 is also a point of density ≥ 1 .

Turning now to a sequence T_{0, r_n} of dilated currents, with a limiting cone

T_∞ , we can take the proper transforms $(\Phi^{-1})_*T_{0,r_n}$ and find that all of them share the features just described, with the same y_0 . But going to the limit we realize that $(\Phi^{-1})_*T_{0,r_n}$ weakly converge to the proper transform $(\Phi^{-1})_*T_\infty$, which is also $(1, 1)$ and positive.

The mass is continuous under weak convergence of positive (or calibrated) currents, therefore y_0 is a point of density ≥ 1 for $(\Phi^{-1})_*T_\infty$. This limit, however, is of a very peculiar form, being the transform of a cone. Recall that the fibers of $\tilde{\mathbb{C}}^{n+1}$ are holomorphic planes coming from holomorphic planes through the origin of \mathbb{C}^{n+1} . Since T_∞ is a positive $(1, 1)$ -cone, it is made of a weighted family of holomorphic disks through the origin, as described in (4.3), and the weight is a positive measure. Then $(\Phi^{-1})_*T_\infty$ is made of a family of fibers of the line bundle $\tilde{\mathbb{C}}^{n+1}$ with a positive weight. Then the fact that y_0 has density ≥ 1 implies that the whole fiber L^{y_0} at y_0 is counted with a weight ≥ 1 . Transforming back, T_∞ must contain the plane $\Phi(L^{y_0})$ with a weight ≥ 1 .

But the density of T at the origin is 1, so there is no space for anything else and T_∞ **must be** the disk $\Phi(L^{y_0})$ with multiplicity 1. Since we started from an arbitrary sequence r_n , the proof is complete, and it is also clear that $\frac{x_m}{|x_m|}$ cannot have accumulation points other than y .

In the almost complex setting we need to adapt the algebraic blow up, respecting the almost complex structure. Up to passing to a chart we assume to be in the unit ball $B_1^{2n+2} \subset \mathbb{C}^{n+1}$ endowed with an almost complex structure J . In order to adapt the algebraic blow up with respect to J , we employ a pseudo holomorphic polar foliation: we have a family of pseudo holomorphic embedded disks through the origin: these disks foliate a sector \mathcal{S} of the form $\{(z_0, \dots, z_n) \in B_1^{2n+2} \subset \mathbb{C}^{n+1} : \sum_{j=1}^n |z_j|^2 < |z_0|^2\}$.

Such a foliation was used in dimension 4 in [50] and [58] for slicing techniques employed for regularity results on pseudo holomorphic integral 2-cycles. In this work the foliation allows the construction of coordinates that respect the almost complex structure J and substitute the normal coordinates used in the blow up procedure explained in (4.2). The blow up is then performed with respect to these new coordinates and yields the same tangent cones in the limit.

Due to the non-integrability of J , the polar foliation does not cover the whole unit ball but only a sector \mathcal{S} . This is however enough to adapt the algebraic blow up, although only restricting to this sector. In chapter 4 we will mimic, with the due changes and some careful estimates, the proof sketched just above.

Chapter 2

Special Legendrian cycles in S^5

Let C be a Special Legendrian integral cycle in $S^5 \subset \mathbb{C}^3$, i.e. a 2-dimensional integral current without boundary that is semi-calibrated by the two-form $\omega = \operatorname{Re}(z_1 dz^2 \wedge dz^3 + z_2 dz^3 \wedge dz^1 + z_3 dz^1 \wedge dz^2)$. In this chapter we prove the following result (joint work with Tristan Rivière, [4]), an overview of which was presented in section 1.5.1.

Theorem 2.0.4. *C is, out of isolated points, the current of integration along a smooth Special Legendrian submanifold with a smooth integer multiplicity.*

2.1 Preliminaries: the construction of positively intersecting foliations

In this section we are going to construct in a generic way a smooth 3-surface Σ in S^5 with the property that, anytime Σ intersects a Special Legendrian L transversally, this intersection is positive, i.e., the orientation of $T_p L \wedge T_p \Sigma$ agrees with that of $T_p S^5$ (S^5 being oriented according to the outward normal). Then we will construct foliations made with families of 3-surfaces of this kind.

Contact structure. Now we recall some basic facts on the geometry of the contact structure associated to the Special Legendrian calibration in S^5 , see [33] for more details.

S^5 inherits from the symplectic manifold $(\mathbb{C}^3, \sum_{i=1}^3 dz^i \wedge d\bar{z}^i)$ the contact structure given by the form

$$\gamma := \mathcal{E}^* \iota_N \left(\sum_{i=1}^3 dz^i \wedge d\bar{z}^i \right).$$

This is a 1-form with the contact property saying that $\gamma \wedge (d\gamma)^2 \neq 0$ everywhere; the associated distribution of hyperplanes is $\ker(\gamma(p)) \subset T_p S^5$. In the sequel the hyperplane of the distribution at p will be denoted by H_p^4 , where H stands for horizontal¹. The condition on γ is equivalent to the non-integrability of this distribution, i.e. it is impossible (even locally) to find a 4-surface in S^5 which is everywhere tangent to the H^4 . The vectors v orthogonal to H^4 are called vertical; they are everywhere tangent to the Hopf fibers $e^{i\theta}(z_1, z_2, z_3) \subset S^5$.

Special Legendrians are tangent to the horizontal distribution.

The Special Legendrian calibration ω has the property that any calibrated 2-plane in TS^5 must be contained in H^4 . Therefore, Special Legendrian submanifolds are everywhere tangent to the horizontal distribution and they are a particular case of the so called Legendrian curves, which are the maximal dimensional integral submanifolds of the contact distribution. We can shortly justify this as follows: recall that ω and the horizontal distribution are invariant under the action of $SU(3)$. At the point $(1, 0, 0) \in S^5$ the Special Legendrian semi-calibration is easily² computed: $\omega_{(1,0,0)} = dx^2 \wedge dx^3 - dy^2 \wedge dy^3$. Then if a unit simple 2-vector in $T_{(1,0,0)}S^5$ is calibrated, it must lie in the 4-plane spanned by the coordinates x_2, y_2, x_3, y_3 , which is the horizontal hyperplane $H_{(1,0,0)}^4$ orthogonal to the Hopf fiber $e^{i\theta}(1, 0, 0)$. The $SU(3)$ -invariance of ω and of $\{H^4\}$ implies that, at all points on the sphere, Special Legendrians are tangent to the horizontal distribution.

J-structure and J-invariance. We introduce now a further structure: on each hyperplane H_p^4 , ω restricts to a non-degenerate 2-form, so we get a symplectic structure and we can define the (unique) linear map

$$J_p : H_p^4 \rightarrow H_p^4$$

characterized by the properties that $J_p^2 = -Id$ and, for $v, w \in H_p^4$,

$$\omega(p)(v, w) = \omega(p)(J_p v, J_p w), \quad \langle v, w \rangle_{T_p S^5} = \omega(p)(v, J_p w). \quad (2.1)$$

This is a standard construction from symplectic geometry and the uniqueness of the J_p at each point implies that we get a smooth endomorphism of the horizontal bundle; in our case the setting is simple enough to allow an explicit expression of J_p in coordinates, as follows.

¹This is nothing else but the universal horizontal connection associated to the Hopf projection $S^5 \rightarrow \mathbb{C}P^2$ sending $(z_1, z_2, z_3) \rightarrow [z_1, z_2, z_3]$. The fibers $e^{i\theta}p$, $\theta \in [0, 2\pi]$ and $p \in S^5$, are great circles in S^5 and the hyperplanes H_p^4 of the horizontal distribution are everywhere orthogonal to the fibers. This structure is $SU(3)$ -invariant.

²Recall that we are using standard coordinates $z_j = x_j + iy_j$, $j = 1, 2, 3$ on \mathbb{C}^3 .

$\omega_{(1,0,0)} = dx^2 \wedge dx^3 - dy^2 \wedge dy^3$ and recall that $H_{(1,0,0)}^4$ is spanned by the coordinates x_2, y_2, x_3, y_3 . Then choose

$$J_{(1,0,0)} := \begin{cases} \frac{\partial}{\partial x_2} & \rightarrow \frac{\partial}{\partial x_3} \\ \frac{\partial}{\partial y_2} & \rightarrow -\frac{\partial}{\partial y_3} \end{cases} .$$

The conditions in (2.1) hold true at this point.

For any $p \in S^5$, take $g \in SU(3)/SU(2)$ sending p to $(1, 0, 0)$. The $SU(2)$ in the quotient is the stabilizer of $H_{(1,0,0)}^4$. This stabilizer leaves $J_{(1,0,0)}$ invariant (any element of $SU(2)$ commutes with $J_{(1,0,0)}$) and we can define, for $v \in H_p^4$,

$$J_p(v) := dg^{-1}(J_{(1,0,0)}(dg(v))).$$

Thus we get a smooth J -structure on the horizontal bundle.

From the properties in (2.1), if a simple unit 2-vector $v \wedge w$ in H_p^4 is calibrated by ω , then

$$1 = \omega_p(v, w) = \omega_p(J_p v, J_p w) = \langle J_p v, w \rangle_{T_p S^5}$$

so

$$v \wedge w \text{ is a Special Legendrian plane} \Leftrightarrow J_p(v \wedge w) := J_p v \wedge J_p w = v \wedge w,$$

i.e.

Proposition 2. *A 2-plane in $T_p S^5$ is Special Legendrian if and only if it lies in H_p^4 (horizontal for the Hopf connection) and it is J_p -invariant for the J -structure above.*

Since all the above introduced objects are invariant under the action of $SU(3)$, we can afford to work at a given point of S^5 ; from now on we will focus on a neighbourhood of the point $(1, 0, 0) \in S^5$, where we are using the complex coordinates $(z_1, z_2, z_3) = (x_1, y_1, x_2, y_2, x_3, y_3)$ of \mathbb{C}^3 .

Positive 3-surface. We are now ready for the construction of a 3-surface with the property of positive intersection.

Oriented m -planes in \mathbb{C}^3 will be identified with unit simple m -vectors in \mathbb{C}^3 . In particular, TS^5 is oriented so that $TS^5 \wedge \frac{\partial}{\partial r} = \mathbb{C}^3$.

Writing down the Special Lagrangian calibration explicitly

$$\Omega = dx^1 \wedge dx^2 \wedge dx^3 - dx^1 \wedge dy^2 \wedge dy^3 - dy^1 \wedge dx^2 \wedge dy^3 - dy^1 \wedge dy^2 \wedge dx^3,$$

it is straightforward to see that

$$\mathcal{L}_0 = \frac{\partial}{\partial x_1} \wedge \frac{\partial}{\partial x_2} \wedge \frac{\partial}{\partial x_3}$$

is a Special Lagrangian 3-plane passing through the origin of \mathbb{C}^3 and through the point $(1, 0, 0)$. We now consider, for a small positive ε , the following family $\{\mathcal{L}_\theta\}_{\theta \in (-\varepsilon, \varepsilon)}$ of Special Lagrangian planes, where $\{(e^{i\theta}, 0, 0)\}_{\theta \in (-\varepsilon, \varepsilon)}$ is the fiber containing $(1, 0, 0)$ and \mathcal{L}_θ goes through the point $(e^{i\theta}, 0, 0)$:

$$\begin{aligned} \mathcal{L}_\theta &= \left(\begin{array}{ccc} e^{i\theta} & 0 & 0 \\ 0 & e^{-i\theta} & 0 \\ 0 & 0 & 1 \end{array} \right) \mathcal{L}_0 = \\ &= \left(\cos \theta \frac{\partial}{\partial x_1} + \sin \theta \frac{\partial}{\partial y_1} \right) \wedge \left(\cos \theta \frac{\partial}{\partial x_2} - \sin \theta \frac{\partial}{\partial y_2} \right) \wedge \frac{\partial}{\partial x_3}, \end{aligned}$$

which is Special Lagrangian since it has been obtained by pushing forward \mathcal{L}_0 by an element in $SU(3)$.

We introduce the 4-surface Σ^4 in \mathbb{C}^3 obtained by attaching the \mathcal{L}_θ -planes along the fiber $\{(e^{i\theta}, 0, 0)\}_{\theta \in (-\varepsilon, \varepsilon)}$: this 4-surface can be expressed as

$$\Sigma^4 = (ae^{i\theta}, be^{-i\theta}, c),$$

parametrized with $(a, b, c) \in \mathbb{R}^3 \setminus \{0\}$, $\theta \in (-\varepsilon, \varepsilon)$. Then define

$$\Sigma = \Sigma^4 \cap S^5.$$

As stated in the coming lemma 2.1.1, this 3-surface has the desired property of intersecting Special Legendrians positively.

We can make the equivalent construction starting from the form ω restricted to the fiber $\{(e^{i\theta}, 0, 0)\}_{\theta \in (-\varepsilon, \varepsilon)}$, namely

$$\omega = \cos \theta (dx^2 \wedge dx^3 - dy^2 \wedge dy^3) + \sin \theta (-dx^2 \wedge dy^3 - dy^2 \wedge dx^3),$$

and explicitly writing down the J-structure on $H^4_{(e^{i\theta}, 0, 0)}$ introduced above. On $H^4_{(e^{i\theta}, 0, 0)}$ we can use coordinates (x_2, y_2, x_3, y_3) since $H^4 \wedge v = TS^5$, $TS^5 \wedge \frac{\partial}{\partial r} = \mathbb{C}^3$ and $v = i \frac{\partial}{\partial r}$, so $H^4 = \frac{\partial}{\partial x_2} \wedge \frac{\partial}{\partial y_2} \wedge \frac{\partial}{\partial x_3} \wedge \frac{\partial}{\partial y_3}$.

$$J_\theta = J_{(e^{i\theta}, 0, 0)} := \begin{cases} \frac{\partial}{\partial x_2} & \rightarrow \cos \theta \frac{\partial}{\partial x_3} - \sin \theta \frac{\partial}{\partial y_3} \\ \frac{\partial}{\partial y_2} & \rightarrow -\cos \theta \frac{\partial}{\partial y_3} - \sin \theta \frac{\partial}{\partial x_3} \\ \frac{\partial}{\partial x_3} & \rightarrow -\cos \theta \frac{\partial}{\partial x_2} + \sin \theta \frac{\partial}{\partial y_2} \\ \frac{\partial}{\partial y_3} & \rightarrow \cos \theta \frac{\partial}{\partial y_2} + \sin \theta \frac{\partial}{\partial x_2} \end{cases}.$$

So J_θ is represented by the matrix $J_0 A_\theta$, where ³

³In complex notation, looking at $H^4_{(e^{i\theta}, 0, 0)}$ as $\mathbb{C}^2_{z_2, z_3}$, we can write

$$A_\theta = \begin{pmatrix} e^{i\theta} & 0 \\ 0 & e^{-i\theta} \end{pmatrix}.$$

$$J_0 = \begin{pmatrix} 0 & 0 & -1 & 0 \\ 0 & 0 & 0 & 1 \\ 1 & 0 & 0 & 0 \\ 0 & -1 & 0 & 0 \end{pmatrix}, \quad A_\theta = \begin{pmatrix} \cos \theta & \sin \theta & 0 & 0 \\ -\sin \theta & \cos \theta & 0 & 0 \\ 0 & 0 & \cos \theta & -\sin \theta \\ 0 & 0 & \sin \theta & \cos \theta \end{pmatrix}.$$

If $v \wedge w$ is a J-invariant 2-plane in H_0^4 , with $w = J_0 v$, then $A_\theta^{-1} v \wedge w$ is J_θ invariant, in fact $J_\theta(A_\theta^{-1} v) = J_0 A_\theta A_\theta^{-1} v = J_0 v = w$. Take the geodesic 2-sphere L_0 tangent to the J_0 -holomorphic plane

$$\frac{\partial}{\partial x_2} \wedge \frac{\partial}{\partial x_3}.$$

This Special Legendrian 2-sphere L_0 coincides with $\mathcal{L}_0 \cap S^5$ introduced above. The 2-plane

$$A_\theta^{-1} \frac{\partial}{\partial x_2} \wedge \frac{\partial}{\partial x_3} = \left(\cos \theta \frac{\partial}{\partial x_2} - \sin \theta \frac{\partial}{\partial y_2} \right) \wedge \frac{\partial}{\partial x_3}$$

is therefore J_θ holomorphic and the geodesic 2-sphere tangent to it is $\mathcal{L}_\theta \cap S^5$. Σ is the 3-surface obtained from the union of those Special Legendrian spheres as $\theta \in (-\varepsilon, \varepsilon)$.

Lemma 2.1.1. *There is an $\varepsilon_0 > 0$ small enough such that for any $\varepsilon < \varepsilon_0$ the following holds:*

let S be any Special Legendrian current in $B_\varepsilon(1, 0, 0) \subset S^5$; then, at any point p where $T_p S$ is defined and transversal to $T_p \Sigma$, S and Σ intersect each other in a positive way, i.e.

$$T_p S \wedge T_p \Sigma = T_p S^5.$$

proof of lemma 2.1.1.

$$T_{(e^{i\theta}, 0, 0)} \Sigma = A_\theta^{-1} \frac{\partial}{\partial x_2} \wedge \frac{\partial}{\partial x_3} \wedge v_\theta,$$

so, along the fiber, the tangent space to Σ is spanned by two vectors l^1, l^2 such that $l^1 \wedge l^2$ is Special Legendrian and by the vertical vector v_θ . At any other point p of Σ , the tangent space always contains two directions l_p^1, l_p^2 such that $l_p^1 \wedge l_p^2$ is Special Legendrian (from the construction of Σ). The third vector w , orthogonal to these two and such that $l_p^1 \wedge l_p^2 \wedge w = T\Sigma$, drifts from the vertical direction as the point moves away from the fiber, but by continuity, for a small neighbourhood $B_\varepsilon(1, 0, 0)$, we still have that

$$H_p^4 \wedge w_p = T_p S^5.$$

On the other hand, it is a general fact that, given a 4-plane with a J-structure, two transversal J-invariant planes always intersect positively. Therefore

$$T_p S \wedge l_p^1 \wedge l_p^2 = H_p^4$$

at any point p , so

$$T_p S \wedge T_p \Sigma = T_p S \wedge (l_p^1 \wedge l_p^2 \wedge w_p) = (T_p S \wedge l_p^1 \wedge l_p^2) \wedge w_p = T_p S^5.$$

□

First parallel foliation. Now we are going to exhibit a 2-parameter family of 3-surfaces that foliate $B_\varepsilon(1, 0, 0)$ and have the property of positive intersection. Consider the Special Legendrian 2-sphere

$$L = \left(-\frac{\partial}{\partial x_1} \wedge \frac{\partial}{\partial y_2} \wedge \frac{\partial}{\partial y_3} \right) \cap S^5.$$

This is going to be the space of parameters. Consider $SO(3)$ and let it act on the 3-space $-\frac{\partial}{\partial x_1} \wedge \frac{\partial}{\partial y_2} \wedge \frac{\partial}{\partial y_3}$. We are only interested in the subgroup of rotations having axis in the plane $\frac{\partial}{\partial y_2} \wedge \frac{\partial}{\partial y_3}$. This subgroup is isomorphic to $SO(3)/S$, where S is the stabilizer of a point, in our case the point $(1, 0, 0) \in -\frac{\partial}{\partial x_1} \wedge \frac{\partial}{\partial y_2} \wedge \frac{\partial}{\partial y_3}$. Thus the rotations in this subgroup can be parametrized over the points of $L = \left(-\frac{\partial}{\partial x_1} \wedge \frac{\partial}{\partial y_2} \wedge \frac{\partial}{\partial y_3} \right) \cap S^5$ and we will write A_q for the rotation sending $(1, 0, 0)$ to $q \in L$. We extend A_q to a rotation of the whole S^5 by letting it act diagonally on $\mathbb{R}^3 \oplus \mathbb{R}^3 = \mathbb{C}^3$. Then define

$$\Sigma_q = A_q(\Sigma),$$

for $q \in L$. Since $A_q \in SU(3)$, Special Legendrian spheres are invariant and $A_q(e^{i\theta}(1, 0, 0)) = e^{i\theta}A_q((1, 0, 0)) = e^{i\theta}q$, so the fiber through $(1, 0, 0)$ is sent into the fiber through q . Therefore, for a fixed q , Σ_q is a 3-surface of the same type as Σ , that is, it contains the fiber through q and is made of the union of Special Legendrian spheres smoothly attached along the fiber. By the $SU(3)$ -invariance of ω , from lemma 2.1.1 we get that Σ_q has the property of intersecting positively any transversal Special Legendrian S .

For the sequel define $L_\varepsilon = L \cap B_\varepsilon(1, 0, 0)$.

Lemma 2.1.2. *The 3-surfaces Σ_q , as $q \in L_\varepsilon$, foliate a neighbourhood of $(1, 0, 0)$ in S^5 .*

proof of lemma 2.1.2. Parametrize L_ε with normal coordinates (s, t) , with $\frac{\partial}{\partial s} = \frac{\partial}{\partial y_2}$, $\frac{\partial}{\partial t} = -\frac{\partial}{\partial y_3}$ and $\Sigma = \Sigma_0$ with $(a, b, c, \theta) \in (S^2 \cap B_\varepsilon(1, 0, 0)) \times (-\varepsilon, \varepsilon)$, with $(a, b, c) \in S^2 \subset \mathbb{R}^3 = \frac{\partial}{\partial x_1} \wedge \frac{\partial}{\partial x_2} \wedge \frac{\partial}{\partial x_3}$ and $\theta \in (-\varepsilon, \varepsilon)$ as done during the construction (we set $a = (1 - b^2 - c^2)^{1/2}$). Consider the function $\psi : \Sigma \times L_\varepsilon \rightarrow S^5$ defined as

$$\psi(p, q) = A_q(p)$$

for $p = (b, c, \theta) \in \Sigma$, $q = (s, t) \in L_\varepsilon$. Analysing the action of the differential $d\psi$ on the basis vectors at $(0, 0) \in \Sigma \times L_\varepsilon$ we get:

$$\frac{\partial \psi}{\partial b} = \frac{\partial}{\partial x_2}, \frac{\partial \psi}{\partial c} = \frac{\partial}{\partial x_3}, \frac{\partial \psi}{\partial \theta} = \frac{\partial}{\partial y_1}, \frac{\partial \psi}{\partial s} = \frac{\partial}{\partial y_2}, \frac{\partial \psi}{\partial t} = -\frac{\partial}{\partial y_3}.$$

So the Jacobian determinant at 0 is 1 and ψ is a diffeomorphism in some neighbourhood of $(1, 0, 0)$ where we can introduce the new set of coordinates (b, c, θ, s, t) . Therefore, the family $\{\Sigma_{s,t}\}_{(s,t) \in L}$ foliates an open set that we can assume to be $\psi(\Sigma \times L_\varepsilon)$ if both Σ and L_ε were taken small enough. \square

Coordinates induced by the first parallel foliation. Recall that, in each H_p^4 we are interested in the possible calibrated 2-planes, which, as shown above, must be J_p -invariant. The set of these 2-planes is parametrized by the complex lines in \mathbb{C}^2 and is therefore diffeomorphic to $\mathbb{C}\mathbb{P}^1$. We are often going to identify H^4 with \mathbb{C}^2 (respectively $\mathbb{C}\mathbb{P}^1$, if we are interested in the complex lines) with the following coordinates: on $H_{(1,0,0)}^4$ we set $H_{(1,0,0)}^4 = TL \oplus T(L_0) = \mathbb{C}_{s+it} \oplus \mathbb{C}_{b+ic}$, where L, L_0 are the Special Legendrians introduced above; TL, TL_0 are \mathbb{C} -orthogonal complex lines in $H_{(1,0,0)}^4$, $TL = \frac{\partial}{\partial s} \wedge \frac{\partial}{\partial t}$ and $TL_0 = \frac{\partial}{\partial b} \wedge \frac{\partial}{\partial c}$. Then the complex line L will be represented by $[1, 0]$ in $\mathbb{C}\mathbb{P}^1$ and L_0 by $[0, 1]$. Extend these coordinates to the other hyperplanes H^4 as follows: at any H_p^4 we have that, for the unique Σ containing p :

$$T_p L = [1, 0], \quad T_p \Sigma \cap H_p^4 = [0, 1]. \quad (2.2)$$

Families of parallel foliations. We will often need to use not only the foliation constructed, but a family of foliations. Keeping as base coordinates the coordinates that we just introduced, we can perform a similar construction. The foliation we constructed is parametrized by $q \in L$ with the property that $T_q \Sigma_q \cap H_q^4 = [0, 1] \in \mathbb{C}\mathbb{P}^1$. For X in a neighbourhood of $[0, 1] \in \mathbb{C}\mathbb{P}^1$, e.g. $\{X = [Z, W] \in \mathbb{C}\mathbb{P}^1, : |Z| \leq |W|\}$, we start from the 3-surface Σ_0^X built as follows: the Special Legendrian spheres that we attach to the fiber should have tangent planes in the direction $X \in \mathbb{C}\mathbb{P}^1$. Then,

for any such fixed X , we still have a foliation of a neighbourhood of $(1, 0, 0)$, parametrized on L and made of the 3-surfaces

$$\Sigma_q^X := A_q(\Sigma_0^X), \quad q \in L. \quad (2.3)$$

We will refer to Σ_q^X as to the 3-surface born at q in the direction X . The original surfaces we built will be denoted $\Sigma^{[0,1]}$. By the $SU(3)$ -invariance of ω , from lemma 2.1.1 we get the positiveness property for Σ_q^X :

Corollary 2.1.1. *For any q , Σ_q^X has the property of intersecting positively any transversal Special Legendrian S , i.e. at any point p where $T_p S$ is defined and transversal to $T_p \Sigma_q^X$,*

$$T_p S \wedge T_p \Sigma_q^X = T_p S^5.$$

For a fixed X , a parallel foliation $\{\Sigma_p^X\}$ (as p ranges over L_ε) gives rise in a neighbourhood of $(1, 0, 0)$ to a system of five real coordinates. The adjective *parallel* is reminiscent of this resemblance to a cartesian system of coordinates in the chosen neighbourhood. There are several reasons why we produced parallel foliations keeping freedom on the "direction" X ; they will be clear later on.

Families of polar foliations. So far we have been dealing with "parallel" foliations. We turn now to "polar" foliations⁴.

Notice that, a point in L being fixed, say 0, we have that, as X runs over a neighbourhood of $[0, 1] \in \mathbb{CP}^1$, the family $\{\Sigma_0^X\}$ foliates a conic neighbourhood of $\Sigma_0^{[0,1]}$. Observe that the rotations in $SO(3) \subset SU(3)$ fixing the fiber through $q \in S^5$ have for differentials exactly the rotations in $SU(2)$ on H_q^4 . Denoting $R_{X,Y}$ the rotation whose differential sends X to $Y \in H_q^4$, we have $R_{X,Y}(\Sigma_q^X) = \Sigma_q^Y$.

Lemma 2.1.3. *With the above notations, let U be a small enough neighbourhood of $Y \in \mathbb{CP}^1$ and consider Σ_q^Y for some point q . Let $L^Y \subset \Sigma_q^Y$ be the Special Legendrian 2-sphere tangent to Y at q . Then*

$$(\cup_{X \in U} \Sigma_q^X) - \{e^{i\theta} q\}$$

is a neighbourhood of $L^Y - \{q\}$.

proof of lemma 2.1.3. Introduce the function $\psi : \Sigma \times U \rightarrow S^5$ sending (p, X) , $p \in \Sigma = \Sigma_q^Y$, $X \in U$, to the point $R_{Y,X}(p) \in \Sigma_q^X$. Observe that, in a neighbourhood of $(1, 0, 0)$, the differential of ψ is different from zero except

⁴The term *polar* is used as reminiscent of the standard polar coordinates in the plane.

at the points of the Hopf fiber through $(1, 0, 0)$. Indeed, on this fiber, $d\psi$ restricted to the 3-space $T\Sigma$ has rank 3 and $T\Sigma \cong Y_1 \wedge Y_2 \wedge v$, with $Y_1 \wedge Y_2$ the 2-plane in \mathbb{C}^2 represented by Y . At any point F among these, $d\psi$ is zero on the tangent space to U at Y , since the image $\psi(F, X)$ is constantly equal to F for any X . For any fixed point p not on the fiber and for X on a curve in U through Y , $\psi(p, X)$ is a curve transversal to Σ_p^Y , since we are moving p by the rotation $R_{Y,X}$. Therefore the differential $d\psi(p, Y)$ has rank 2 when restricted to the tangent to U at Y , while on the complementary 3-space $d\psi$ still has rank 3 by smoothness. Therefore we get the desired result. \square

Remark 2.1.1. We remark here that a 3-surface Σ of the type just exhibited above, is foliated by Special Legendrian spheres, so the Special Legendrian structure restricted to Σ is integrable; a Special Legendrian integral cycle contained in such a Σ must locally be one of these spheres.

Remark 2.1.2. With the above notations, $L_0 + L$ is a Special Legendrian cycle with isolated singularities at the points $(1, 0, 0)$ and $(-1, 0, 0)$. This example shows that our regularity result is optimal. The reader may consult [33] for further explicit examples of Special Legendrian surfaces.

2.2 Tools from intersection theory

In this section we recall some basic facts about the blowing-up of the current at a point and about the Kronecker intersection index (for the related issues in geometric measure theory we refer to [28]); then we show that this index is preserved when we send a blown-up sequence to the limit.

Let C be the Special Legendrian cycle that we are studying. The blow-up analysis of the current C around a point x_0 is performed as follows: consider a dilation of C around x_0 of factor r which, in normal coordinates around x_0 , is expressed by the push-forward of C under the action of the map $\frac{x - x_0}{r}$:

$$C_{x_0,r}(\psi) = \left[\left(\frac{x - x_0}{r} \right)_* C \right] (\psi) = C \left(\left(\frac{x - x_0}{r} \right)^* \psi \right).$$

From [47] or [53] we have the monotonicity formula⁵ which states that, for any x_0 , the function *mass ratio*, i.e.

$$\frac{M(C \llcorner B_r(x_0))}{r^2},$$

⁵This formula is proved in [47] for semi-calibrated currents and in [53] for currents of vanishing mean curvature; both cases apply here. The result from [47] is recalled in the appendix.

is monotonically non-increasing as $r \downarrow 0$, therefore⁶ the limit

$$\theta(x) := \lim_{r \rightarrow 0} \frac{M(C \llcorner B_r(x))}{\pi r^2}$$

exists for any point $x \in S^5$. This limit coincides (a.e.) with the multiplicity θ assigned in the definition⁷ of integer cycle, whence the use of the same notation. We can therefore speak of the *multiplicity function* θ as a (everywhere) well-defined function on \mathcal{C} .

We recall the definitions of weak-convergence and flat-convergence for a sequence T_n of currents in \mathcal{R}_m to $T \in \mathcal{R}_m$. We remark, however, that the notions of weak-convergence and flat-convergence turn out to be equivalent for integral currents of equibounded mass and boundary mass (as it is in our case), see 31.2 of [53] or [28], page 516.

We say that $T_n \rightarrow T$ *weakly* when we look at the dual pairing with m -forms, i.e. if $T_n(\psi) \rightarrow T(\psi)$ for any smooth and compactly supported m -form ψ .

$T_n \rightarrow T$ *in the Flat-norm* if the quantity $\mathcal{F}(T - T_n) := \inf\{M(A) + M(B) : T - T_n = A + \partial B, A \in \mathcal{R}_m, B \in \mathcal{R}_{m+1}\}$ goes to 0 as $n \rightarrow \infty$.

The fact that $\frac{M(C \llcorner B_r(x_0))}{r^2}$ is monotonically non-increasing as $r \downarrow 0$ gives that, for $r \leq r_0$ (for a small enough r_0), we are dealing with a family of currents $\{C_{x_0, r}\}$ which are boundaryless and locally equibounded in mass; by Federer-Fleming's compactness theorem⁸, there exist a sequence $r_n \rightarrow 0$ and a rectifiable boundaryless current C_∞ such that

$$C_{x_0, r_n} \rightarrow C_\infty \text{ in Flat-norm.}$$

C_∞ turns out to be a cone (a so called tangent cone to C at x_0) with density at the origin the same as the density of C at x_0 and calibrated by ω_{x_0} (see [30] section II.5); being J_{x_0} -holomorphic, this cone must be a sum of J_{x_0} -holomorphic planes, so $C_\infty = \bigoplus_{i=1}^Q D_i$, where the D_i 's are (possibly coinciding) Special Legendrian disks. In particular, the multiplicity (the limit of the mass ratio) θ is everywhere \mathbb{N} -valued in our case.

⁶To be precise, due to the fact that the metric is not flat, the mass ratio is almost monotone, i.e. $\frac{M(C \llcorner B_r(x_0))}{r^2} = R(r) + O(r)$ for a function R which is monotonically non-increasing as $r \downarrow 0$ and tends to the multiplicity at x_0 as $r \downarrow 0$, and a function $O(r)$ which is infinitesimal. The additional infinitesimal term $O(r)$ does not affect the analysis we need to perform.

⁷The multiplicity θ can be assumed to be positive by choosing the right orientation for the approximate tangent planes to the current.

⁸See [28] page 141.

An important question for regularity issues is to know whether this tangent cone is unique or not, or, in other words, if C_∞ is independent of the chosen $\{r_n\}$: the answer happens to be positive in our situation. We are going to give a self-contained proof of it in the next section (theorem 2.3.1) based on the tools from this section.

What kind of geometric information can we draw from the existence of a tangent cone? The following lemma shows that, considering a blown-up sequence C_{x_0, r_n} tending to one possible tangent cone C_∞ , we can fix a conic neighbourhood of C_∞ , as narrow as we want, and if we neglect a ball around zero of any radius $R < 1$ the restrictions of C_{x_0, r_n} to the annulus $B_1 \setminus B_R$ are supported in the chosen conic neighbourhood for n large enough⁹.

Remark 2.2.1. It is a standard fact that two distinct sequences C_{x_0, r_n} and C_{x_0, ρ_n} must tend to the same tangent cone if $a \leq \frac{r_n}{\rho_n} \leq b$ for some positive numbers a and b . See [43].

Lemma 2.2.1. *Let C be a Special Legendrian cycle with $x_0 \in C$ and let $0 < R < 1$. With the above notations, let $\rho_n \rightarrow 0$ be such that $C_{x_0, \rho_n} \rightharpoonup C_\infty = \bigoplus_{i=1}^Q D_i$. Denote by A_R the annulus $\{x \in B_1(0), |x| \geq R\}$ and by E_ε the set $\{x \in B_1(0), \text{dist}(x, C_\infty) < \varepsilon |x|\}$. Then, for any $\varepsilon > 0$, there is $n_0 \in \mathbb{N}$ large enough such that*

$$\text{spt}C_{x_0, \rho_n} \cap A_R \subset E_\varepsilon$$

for $n \geq n_0$.

proof of lemma 2.2.1. Arguing by contradiction, we assume the existence of $\varepsilon_0 > 0$ such that

$$\forall n \exists x_n \in \text{spt}C_{x_0, \rho_n} \cap E_{\varepsilon_0}^c \cap A_R.$$

Recall that the sequence $C_{x_0, \rho_n |x_n|}$ also converges weakly to the same tangent cone C_∞ since $R \leq \frac{\rho_n |x_n|}{\rho_n} \leq 1$ (previous remark). From the monotonicity formula we have

$$M \left(C_{x_0, \rho_n |x_n|} \llcorner B_{\frac{\varepsilon_0}{2}} \left(\frac{x_n}{|x_n|} \right) \right) \geq \frac{\pi \varepsilon_0^2}{4}.$$

By compactness, modulo extraction of a subsequence, we can assume that $\frac{x_n}{|x_n|} \rightarrow x_\infty \in \partial B_1 \cap E_{\varepsilon_0}^c$. Then, since for n large enough $B_{\frac{3\varepsilon_0}{4}}(x_\infty) \supset B_{\frac{\varepsilon_0}{2}} \left(\frac{x_n}{|x_n|} \right)$, we get

$$M \left(C_{x_0, \rho_n |x_n|} \llcorner B_{\frac{3\varepsilon_0}{4}}(x_\infty) \right) \geq \frac{\pi \varepsilon_0^2}{4}.$$

⁹Recall that $C_{x_0, r}$ lives in a normal chart centered at 0.

Recall that, from the semi-calibration property, we have

$$M\left(C_{x_0, \rho_n |x_n|} \lrcorner B_{\frac{3\varepsilon_0}{4}}(x_\infty)\right) = \left(C_{x_0, \rho_n |x_n|} \lrcorner B_{\frac{3\varepsilon_0}{4}}(x_\infty)\right) \left(\frac{id}{\rho_n |x_n|} \ast \omega\right);$$

moreover

$$\frac{id}{\rho_n |x_n|} \ast \omega \xrightarrow{C_\infty(B_1)} \omega_0$$

as $n \rightarrow \infty$, where ω_0 is the constant 2-form $\omega(0)$. Putting all together, we can write (the first equality expresses the fact that ω_0 is a calibration for C_∞)

$$\begin{aligned} M\left(C_\infty \lrcorner B_{\frac{3\varepsilon_0}{4}}(x_\infty)\right) &= \left(C_\infty \lrcorner B_{\frac{3\varepsilon_0}{4}}(x_\infty)\right) (\omega_0) = \\ &= \lim_n \left(C_{x_0, \rho_n |x_n|} \lrcorner B_{\frac{3\varepsilon_0}{4}}(x_\infty)\right) (\omega_0) = \lim_n \left(C_{x_0, \rho_n |x_n|} \lrcorner B_{\frac{3\varepsilon_0}{4}}(x_\infty)\right) \left(\frac{id}{\rho_n |x_n|} \ast \omega\right) = \\ &= \lim_n M\left(C_{x_0, \rho_n |x_n|} \lrcorner B_{\frac{3\varepsilon_0}{4}}(x_\infty)\right) \geq \frac{\pi \varepsilon_0^2}{4}, \end{aligned} \quad (2.4)$$

which contradicts the fact that $spt C_\infty \cap B_{\frac{3\varepsilon_0}{4}}(x_\infty) = \emptyset$. \square

We need some more tools from intersection theory. For the theory of intersection and of the Kronecker index we refer to [28], chap.5, sect. 3.4. We recall the definition of the index relevant to our case.

Let $f : \mathbb{R}^5 \times \mathbb{R}^5 \rightarrow \mathbb{R}^5$ be the function $f(x, y) = x - y$. The *Kronecker intersection index* $k(S, T)$ for two currents of complementary dimensions $S \in \mathcal{R}_k(\mathbb{R}^5), T \in \mathcal{R}_{5-k}(\mathbb{R}^5)$ is defined under the following conditions:

$$spt S \cap spt(\partial T) = \emptyset \text{ and } spt T \cap spt(\partial S) = \emptyset, \quad (2.5)$$

which imply

$$0 \notin f(spt(\partial(S \times T))).$$

Then there is an $\varepsilon > 0$ such that $B_\varepsilon(0) \cap f(spt(\partial(S \times T))) = \emptyset$. By the constancy theorem ([28] page 130) we can define the index $k(S, T)$ as the only number such that¹⁰

$$f_*(S \times T) \lrcorner B_\varepsilon(0) = k(S, T) \llbracket B_\varepsilon(0) \rrbracket.$$

$k(S, T)$ turns out to be an integer.

For S, T as above, whenever the intersection $S \cap T$ exists (in that case, $S \cap T$ is a sum of Dirac deltas with integer weights), then $k(S, T) = (S \cap T)(1)$.

¹⁰We are using f_* to denote the push-forward under f ; in [28] the notation is $f_\#$. The brackets $\llbracket B_\varepsilon(0) \rrbracket$ denote the current of integration on $B_\varepsilon(0)$.

In particular, when S and T are standard submanifolds $k(S, T)$ just counts intersections with signs as in the classical intersection theory.

In the following lemma we focus on a chosen sequence C_{x_0, ρ_n} converging to a possible cone $C_\infty = \bigoplus_{i=1}^Q D_i$. For notational convenience we set $C_n := C_{x_0, \rho_n} \llcorner B_1(0)$ and $C := C_\infty \llcorner B_1(0)$, always assuming to be in a normal chart with x_0 at the origin.

Lemma 2.2.2. *Let $C_n \rightarrow C$ in B_1 . Take Σ to be any 3-surface such that $\Sigma \cap C \cap \partial B_1 = \emptyset$. Then, for all n large enough, $k(C_n, \Sigma) = k(C, \Sigma)$, where k is the Kronecker index just defined.*

proof of lemma 2.2.2. Define $T_n := C - C_n$. $T_n \rightarrow 0$ in the Flat-norm of B_1 , so we can write $T_n = S_n + \partial R_n$, with $M(T_n) + M(S_n) \rightarrow 0$, where $S_n \in \mathcal{R}_2$ and $R_n \in \mathcal{R}_3$. From the hypothesis on Σ we can choose $\varepsilon > 0$ small enough to ensure that $\Sigma \cap E_\varepsilon \cap A_R = \emptyset$, where $E_\varepsilon \cap A_R = \{x \in B_1, |x| \geq R, \text{dist}(x, C) < \varepsilon |x|\}$, for some suitable $0 < R < 1$. For all n big enough, from lemma 2.2.1, we get that $\text{spt } T_n \cap A_R \subset E_\varepsilon$; in particular, the condition (2.5) on the boundaries of Σ and C is fulfilled and the intersection index $k(T_n, \Sigma)$ is well-defined.

Denote by $\tau_a \Sigma$, as in [28], the push-forward $(\tau_a)_*[\Sigma]$ of Σ by the translation map τ_a , where a is a vector. The Kronecker index is invariant by homotopies keeping the boundaries condition, so we can assume that all the intersections we will deal with are well defined as integer 0-dim rectifiable currents: in fact, for a fixed n , the intersection $T_n \cap \tau_a \Sigma$ exists for a.e. a , and n runs over a countable set. Obviously

$$k(C_n - C, \Sigma) = k(S_n, \Sigma) + k(\partial R_n, \Sigma);$$

we are going to show that both terms on the r.h.s. are zero for n large enough.

From [28] we have that (the index k counts the points of intersection with signs)

$$k(\partial R_n, \Sigma) = (\partial R_n \cap \Sigma)(1).$$

On the other hand,

$$\partial R_n \cap \Sigma = R_n \cap \partial \Sigma - \partial(R_n \cap \Sigma) = -\partial(R_n \cap \Sigma)$$

since $\partial \Sigma = 0$ in B_1 . So

$$\partial(R_n \cap \Sigma)(1) = (R_n \cap \Sigma)(d1) = 0,$$

which implies $k(\partial R_n, \Sigma) = 0$.

Consider now $k(S_n, \Sigma)$ and recall that $\partial S_n = \partial T_n$. We have that $\text{spt } \partial S_n \cap \Sigma =$

\emptyset and $spt S_n \cap \partial \Sigma = \emptyset$, so $0 \notin f(spt(\partial(S_n \times \Sigma)))$ and this index is well-defined and given by

$$f_*(S_n \times \Sigma) = k(S_n, \Sigma)[[B_\varepsilon(0)]],$$

where $f : \mathbb{R}^5 \times \mathbb{R}^5 \rightarrow \mathbb{R}^5$ is $f(x, y) = x - y$ and ε is such that $B_\varepsilon \cap f(spt(\partial(S_n \times \Sigma))) = \emptyset$; thanks to lemma 2.2.1, ε can be chosen independently of n . So, for a fixed ε , we have that

$$f_*(S_n \times \Sigma) = k(S_n, \Sigma)[[B_\varepsilon(0)]] \quad (2.6)$$

holds for all n large enough. By assumption we know that $M(S_n) \rightarrow 0$, therefore $M(S_n \times \Sigma) \rightarrow 0$ and $M(f_*(S_n \times \Sigma)) \rightarrow 0$ since f is Lipschitz; but then, for ε fixed and $k \in \mathbb{N}$, the only possibility for the r.h.s. of (2.6) to go to zero in mass-norm is that eventually $k(S_n, \Sigma) = 0$. So we can conclude that $k(T_n, \Sigma) = 0$ for all large enough n . \square

Remark 2.2.2. If Q is the multiplicity at 0 and $\Sigma = \Sigma_0$ such that Σ_0 is transversal to all D_i that constitute the tangent cone C , then $k(C_i, \Sigma_0) = Q$ for i greater than some i_0 . Once we have this, $k(C_i, \Sigma) = Q$ also holds for any 3-surface Σ that can be joined to Σ_0 via a homotopy during which we do not cross ∂C_i , in particular for small translations $\tau_a \Sigma_0$.

2.3 Before the induction: uniqueness of the tangent cone - easy case of non-accumulation - Lipschitz estimate

The uniqueness of the tangent cone at an arbitrary point of the Special Legendrian follows from the more general result proved in [47] for general semi-calibrated integral 2-cycles. In this section, using the tools developed in the previous sections, we will give a self-contained proof of this uniqueness in our situation. The section then continues with proofs in the same flavour of the two other results quoted in the title of the section.

2.3.1 Uniqueness of the tangent cone

The following lemma (see left picture in figure 2.1) is stated separately since it will be repeatedly recalled in the several proofs of this section. C is our Special Legendrian current.

Lemma 2.3.1. *Let $p \in S^5$ and consider a polar foliation born at p , i.e. a family (Σ_p^X) of 3-surfaces, for X varying in an open ball U of $\mathbb{C}\mathbb{P}^1 \cong \mathbb{P}H_p^4$. For $0 < r < R$, consider the open set*

$$W = (\cup_{X \in U} \Sigma_p^X) \cap (B_R(p) - \overline{B_r(p)}).$$

Assume that $C \llcorner W \neq 0$ and that $\text{spt}(\partial(C \llcorner W)) \subset \cup_{X \in \partial U} \Sigma_p^X$. Then $k(C \llcorner W, \Sigma_p^X) \geq 1$ for any $X \in U$.

Proof of lemma 2.3.1. The carrier of $C \llcorner W$ is just $\mathcal{C} \cap W$, where \mathcal{C} is the carrier of the Special Legendrian current.

Define $s : W \rightarrow U$ to be the smooth function taking the value $Y \in U$ at points of $\Sigma_p^Y \cap W$. From slicing and intersection theory we have the following facts.

- from [28], page 156, we know that the slice $\langle C \llcorner W, s = Y \rangle$ is well-defined for \mathcal{H}^2 almost all $Y \in U$ as a sum of Dirac deltas with integer weights, supported on the finite set of points $\mathcal{C} \cap W \cap s^{-1}\{Y\} = \mathcal{C} \cap W \cap \Sigma_p^Y$. The weight of each Dirac delta is just the multiplicity of the Special Legendrian at that point, with a sign induced by the sign of the intersection of the oriented tangent to \mathcal{C} and the tangent to Σ_p^Y . The sign is always positive in our case, due to the positive intersection property of the foliation.
- recalling that $\langle C \llcorner W, s = Y \rangle = (C \llcorner W) \cap \Sigma_p^Y$, we have that, when the slice $\langle C \llcorner W, s = Y \rangle$ exists, the Kronecker index $k(C \llcorner W, \Sigma_p^Y)$ is just $\langle C \llcorner W, s = Y \rangle(1)$, the sum of the weights of the Dirac deltas that appear in the slice. By the positiveness of intersections we then see that, as long as $(C \llcorner W) \cap \Sigma_p^Y$ exists and $\mathcal{C} \cap W \cap \Sigma_p^Y \neq \emptyset$, the index $k(C \llcorner W, \Sigma_p^Y)$ is strictly positive.

Observe further that, as soon as we have a particular $Y \in U$ for which $k(C \llcorner W, \Sigma_p^Y) \geq 1$, we can say the same for any other $X \in U$, thanks to the hypothesis on the boundary of \mathcal{C} : indeed the 3-surfaces $\Sigma_p^Y \cap W$ and $\Sigma_p^X \cap W$, for any $X, Y \in U$, can be connected by homotopy without crossing $\text{spt}(\partial(C \llcorner W))$, therefore the *intersection index* stays constant.

In view of the observations made, it is enough to have the strict positiveness of $k(C \llcorner W, \Sigma_p^Y)$ for just a single $Y \in U$ in order to conclude the proof of the lemma. Therefore we ask: is it possible that, for almost all $X \in U$ the intersection $\mathcal{C} \cap W \cap \Sigma_p^X$ is empty? Let us analyse what should happen in this case.

If for \mathcal{H}^2 -almost all $X \in U$ the forementioned intersection is empty, we would find by the coarea formula (see [28], Theorem 3, pages 102-103) that

$$\int_{\mathcal{C} \cap W} J_s^C d\mathcal{H}^2 = \int_U \left\{ \int_{s^{-1}\{X\}} d\mathcal{H}^0 \right\} d\mathcal{H}^2(X) = 0,$$

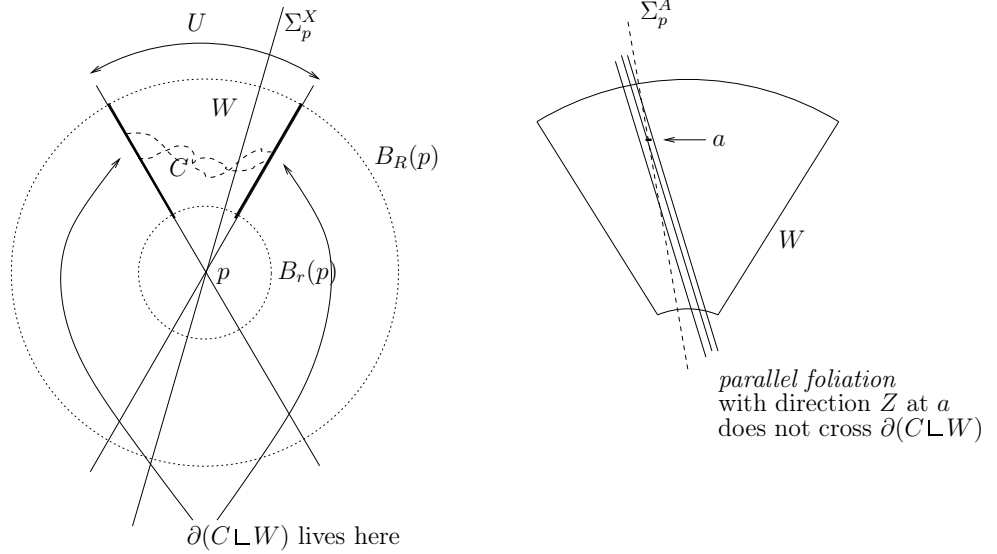

Figure 2.1: On the left: schematical view of the statement. C is dashed. Due to the condition on the boundary of $C \llcorner W$, for any Σ_p^X with $X \in U$ we must find a strictly positive intersection index. On the right: the choice of the *parallel foliation* near a .

where J_s^C is the Jacobian of s relative to the approximate tangent of C . The formula would imply that \mathcal{H}^2 almost everywhere on $C \cap W$ it must hold $J_s^C = 0$, so that each approximate tangent to C must have at least a direction in common with the tangent to Σ_p^X : but thanks to the pseudo-holomorphic behaviour from proposition 2 and the way the 3-surfaces are constructed, this would then force, at almost all points of $C \cap W$, C to be tangent to the 3-surfaces Σ_p^X .

It could be proved directly that this is impossible, since it would force C to be made of a sum of Special Legendrian spheres (some of those building up the 3-surfaces Σ^X), and C would therefore have boundary on ∂B_r and ∂B_R , contradiction.

We prefer however to avoid the technicalities of that proof, and show just the content of the lemma: this can be achieved as follows.

We have seen that, if for \mathcal{H}^2 -almost all $X \in U$ it is true that $C \cap W \cap \Sigma_p^X = \emptyset$, then for \mathcal{H}^2 a.e. $q \in C \cap W$ we must have $T_q C \subset T_q \Sigma_p^X$, for the unique X such that $q \in \Sigma_p^X$.

Take a point $a \in C \cap W$ having density 1 with respect to \mathcal{H}^2 . It exists since $C \cap W$ is non-empty. Denote by Σ_p^A the 3-surface born at p passing through a .

Now take a 3-surface Σ_a^Z born at a , where Z is a direction in $\mathbb{C}P^1 \cong$

$\mathbb{P}H_a^4$ taken such that Σ_a^Z is transversal to Σ_p^A and $\Sigma_a^Z \cap \partial W$ is disjoint from $\cup_{X \in \partial U} \Sigma_p^X$, in particular disjoint from $\text{spt}(\partial(C \llcorner W))$. To ensure that, it is enough to take Σ_a^Z close enough to Σ_p^A .

Take a *parallel foliation* of 3-surfaces Σ_w^Z *parallel* to Σ_a^Z . Choose this *parallel foliation* such that all the Σ_w^Z do not intersect $\text{spt}(\partial(C \llcorner W))$ (figure 2.1, picture on the right), which is ensured if these *parallel* 3-surfaces stay close enough to Σ_a^Z . Any small enough neighbourhood V_a of a is foliated by these *parallel* 3-surfaces Σ_w^Z .

Claim: it is not possible that for \mathcal{H}^2 -almost every 3-surface of the *parallel foliation* it happens $\mathcal{C} \cap V_a \cap \Sigma_w^Z = \emptyset$.

Indeed, if this were the case, we would find, by means of the coarea formula as above, that \mathcal{H}^2 -almost all of $\mathcal{C} \cap V_a$ is tangent to the 3-surfaces Σ_w^Z (remark that, no matter how small V_a is, $\mathcal{H}^2(\mathcal{C} \cap V_a) > 0$ since a has density 1).

But $\mathcal{C} \cap V_a$ cannot simultaneously be tangent to the Σ_w^Z 's and to the Σ_p^X 's. Indeed, Σ_a^Z was chosen transversal to Σ_p^A , so if V_a is small enough, inside V_a we have that, by stability of the transversality, all the Σ_p^X are transversal to all the Σ_w^Z . This proves the claim.

So we can find a \mathcal{H}^2 -positive set of Σ_w^Z such that $\mathcal{C} \cap V_a \cap \Sigma_w^Z \neq \emptyset$. Now, looking at the situation in the whole of W , for \mathcal{H}^2 -almost all the Σ_w^Z 's, the intersection $\mathcal{C} \cap \Sigma_w^Z$ is well-defined and the Kronecker index $k(C \llcorner W, \Sigma_w^Z) = ((C \llcorner W) \cap \Sigma_w^Z)(1)$ must be ≥ 1 due to the strictly positive contribution in V_a .

But Σ_w^Z and Σ_p^A can be joined by homotopy without crossing the boundary of $C \llcorner W$, therefore the index stays constant during the homotopy and $k(C \llcorner W, \Sigma_p^A) \geq 1$. Again by homotopy, we find that for any $Z \in U$ the index $k(C \llcorner W, \Sigma_p^X)$ is a strictly positive integer, concluding the proof. \square

Uniqueness of the tangent cone. We start with the following:

Lemma 2.3.2. *Take any point x_0 of a Special Legendrian cycle C and be Q its multiplicity. Then there exists a unique choice of n distinct Special Legendrian disks D_1, \dots, D_n going through x_0 such that any tangent cone at x_0 must be of the form $T_{x_0}C = \oplus_{k=1}^n N_k D_k$, for some $N_k \in \mathbb{N} \setminus \{0\}$ satisfying $\sum_{k=1}^n N_k = Q$.*

Remark 2.3.1. This result "almost" gives the uniqueness of the tangent cone. What still is missing, is the fact that the multiplicities N_k are also uniquely determined. This will be achieved in theorem 2.3.1.

proof of lemma 2.3.2. We work in a normal chart centered at the origin, so that 0 has multiplicity Q . With a little abuse of notation, we will write $C \llcorner B_r(0)$ (for small enough r) meaning the current, restricted to the geodesic ball of radius r , seen in the chart.

Argue by contradiction: take two tangent cones $C_\infty^{(1)} = \bigoplus_{k=1}^{n_1} N_k^{(1)} D_k^{(1)}$ and $C_\infty^{(2)} = \bigoplus_{k=1}^{n_2} N_k^{(2)} D_k^{(2)}$ having distinct supports, and two blown-up sequences $\{C_{x_0, r_i}\}$ and $\{C_{x_0, \rho_i}\}$ converging to each of them. In this proof we denote $C_{x_0, r} \llcorner B_1(0)$ simply by C_r , so

$$C_{r_i} \rightharpoonup C_\infty^{(1)}, \quad C_{\rho_i} \rightharpoonup C_\infty^{(2)}.$$

As the proof goes on, the reader might refer to figure 2.2 for a schematic visualization of the objects involved.

Take a positive δ much smaller than the angular distance

$$\widehat{C_\infty^{(1)}, C_\infty^{(2)}} := \min_{D_i \neq D_j} \widehat{D_i^{(1)}, D_j^{(2)}} \gg \delta > 0$$

(the distance is given by the Fubini-Study metric in $\mathbb{C}\mathbb{P}^1 \cong \mathbb{P}H_0^4$ and is strictly positive by the contradiction assumption). Moreover assume, without loss of generality, that the disk of $C_\infty^{(1)}$ on which the minimum is achieved is D_0 , the disk represented by $[1, 0] \in \mathbb{C}\mathbb{P}^1$. In particular we are also assuming that D_0 is not in the support of $C_\infty^{(2)}$. By abuse of notation we will write $D_0 \in C_\infty^{(1)}$ to express the fact that D_0 is one of the disks that build up the cone $C_\infty^{(1)}$. Analogously we have $D_0 \notin C_\infty^{(2)}$. Choose ρ_{i_0} such that

- (i) for $j \geq i_0$, $\partial(C \llcorner B_{\rho_j})$ is contained in E_2^δ , the δ -conic-neighbourhood of $C_\infty^{(2)}$ (possible by lemma 2.2.1);
- (ii) $k(C_{\rho_j}, \Sigma_0^{[1,0]}) = Q$ for any $j \geq i_0$. Remark that $\Sigma_0^{[1,0]}$ is transversal to $C_\infty^{(2)}$. By homotopy, it also holds that $k(C_{\rho_j}, \Sigma_0^X) = Q$ for any $j \geq i_0$ and any Σ_0^X with $X \in \mathbb{C}\mathbb{P}^1$ in a δ -neighbourhood of $[1, 0]$. Indeed, the homotopy keeps the condition of non-crossing boundaries expressed in (2.5).

Choose now $r_{i_1} < \rho_{i_0}$ such that

- (iii) denoting by E_0^δ the δ -conic-neighbourhood of D_0 and setting

$$W_1 = (B_{r_{i_1}} \setminus B_{\frac{r_{i_1}}{2}}) \cap E_0^\delta,$$

we have

$$C \llcorner W_1 \neq 0;$$

this is true for i large enough since $C_{r_i} \rightharpoonup C_\infty^{(1)} \ni D_0$.

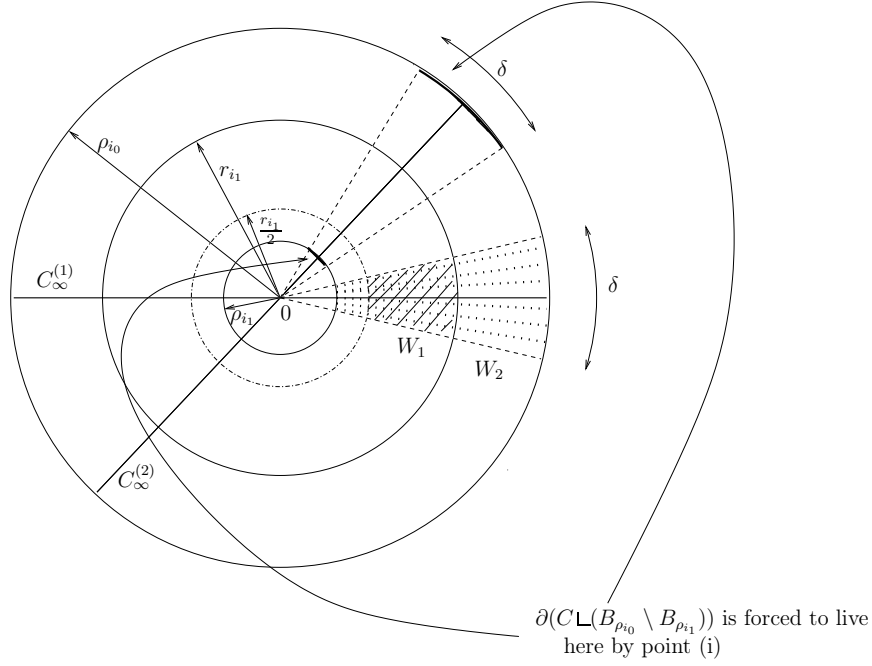

Figure 2.2: In the picture we have taken $C_\infty^{(1)}$ to be Q times D_0 . $C_\infty^{(2)}$ is a different disk counted Q times. The horizontal and vertical directions should be respectively thought of as $[1, 0]$ and $[0, 1]$. The fifth direction should be imagined as entering the picture. The dotted region corresponds to W_2 ; its subset W_1 is shaded.

Take now $\rho_{i_1} \ll \frac{r_{i_1}}{2}$. Define

$$W_2 := (B_{\rho_{i_0}} \setminus B_{\rho_{i_1}}) \cap E_0^\delta \supset W_1.$$

W_2 is foliated by Σ_0^X as X varies in a δ -neighbourhood of $[1, 0]$.

From (i), $\partial(C \llcorner (B_{\rho_{i_0}} \setminus B_{\rho_{i_1}}))$ is zero on $\overline{W_2} \cap \partial B_R$ and on $\overline{W_2} \cap \partial B_r$.

From (iii) we know that $C \llcorner W_2 \neq 0$.

So we can use lemma 2.3.1 in the open set W_2 . Then, for almost all X in the δ -neighbourhood of $[0, 1]$, we have

$$\begin{aligned} k(C \llcorner B_{\rho_{i_0}}, \Sigma_0^X) &= k(C \llcorner B_{\rho_{i_1}}, \Sigma_0^X) + k(C \llcorner (B_{\rho_{i_0}} \setminus B_{\rho_{i_1}}), \Sigma_0^X) = \\ &= k(C_{\rho_{i_1}}, \Sigma_0^X) + k(C \llcorner W_2, \Sigma_0^X) + k(C \llcorner ((B_{\rho_{i_0}} \setminus B_{\rho_{i_1}}) \setminus W_2), \Sigma_0^X) = \\ &= Q + k(C \llcorner W_2, \Sigma_0^X) + k(C \llcorner ((B_{\rho_{i_0}} \setminus B_{\rho_{i_1}}) \setminus W_2), \Sigma_0^X) \geq Q + 1; \end{aligned}$$

the last inequality follows from the positivity (≥ 0) of intersection in $(B_{\rho_{i_0}} \setminus B_{\rho_{i_1}}) \setminus W_2$ and the strict positiveness (≥ 1) guaranteed in W_2 . This contradicts (ii). \square

Now that this "almost uniqueness" of the tangent cone is established, we can improve lemma 2.2.1 as follows:

Lemma 2.3.3. *Let $\{D_k\}_{k=1}^n$ be the uniquely determined disks on which any tangent cone to C at x_0 must be supported. Let us therefore write $T = \cup_k D_k$ for this well-determined support. Denote by E_ε the cone $\{x \in B_1, \text{dist}(x, T) < \varepsilon|x|\}$. Then for any $\varepsilon > 0$ there is ρ_ε small enough such that for any $\rho \leq \rho_\varepsilon$*

$$\text{spt}(C_{x_0, \rho} \llcorner B_1(0)) \setminus \{0\} \subset E_\varepsilon.$$

proof of lemma 2.3.3. The proof is similar to the one of lemma 2.2.1. Assume the existence of $\varepsilon_0 > 0$ and $\rho_n \rightarrow 0$ contradicting the claim and argue as in the proof of lemma 2.2.1. The only modification in the proof consists in using the "almost uniqueness" of the tangent cone at 0 (lemma 2.3.2) instead of the condition $R \leq \frac{\rho_n|x_n|}{\rho_n} \leq 1$. If C_{x_0, ρ_n} converges to the cone $C_\infty = \oplus_{k=1}^n N_k D_k$, then $C_{x_0, \rho_n|x_n|}$ must tend to a limiting cone $\tilde{C}_\infty = \oplus_{k=1}^n \tilde{N}_k D_k$. So the computation in (2.4) can be performed with \tilde{C}_∞ instead of C_∞ , still leading to a contradiction since the supports of \tilde{C}_∞ and C_∞ are the same. \square

Now we can complete the proof of the uniqueness of the tangent cone:

Theorem 2.3.1. *The tangent cone at any point x_0 of a Special Legendrian cycle C is unique.*

proof of theorem 2.3.1. With the result and the notations of lemma 2.3.2 in mind, we only have to exclude that the multiplicities N_k may depend on the chosen sequence that we blow-up.

Choose ε small enough to ensure that different ε -neighbourhoods

$$E_\varepsilon^i = \{x \in B_1, \text{dist}(x, D_i) < \varepsilon|x|\}, \quad E_\varepsilon^j = \{x \in B_1, \text{dist}(x, D_j) < \varepsilon|x|\}$$

of different disks D_i and D_j do not overlap, i.e. $E_\varepsilon^i \cap E_\varepsilon^j = \emptyset$.

Rotate B_1 in order to have that the family $\Sigma_p := \Sigma_p^{[0,1]}$ is transversal to all the disks D_k . Then, for p in a neighbourhood B_δ of 0 and for all small enough r , the index $k(C_r, \Sigma_p)$ is well-defined since lemma 2.3.3 ensures the condition (2.5) of non-crossing-boundaries.

The key observation is that the rescaled C_r form a continuous (with respect to r) family of currents (with respect to the flat-topology) and they are always constrained in the E_ε -neighbourhood given by lemma 2.3.3. Fix i : the fact that the E_ε^k are well separated implies that, for any $p \in B_\delta$,

$$\partial(C_r \llcorner E_\varepsilon^i) \cap \Sigma_p = \emptyset, \quad (C_r \llcorner E_\varepsilon^i) \cap \partial\Sigma_p = \emptyset.$$

Moreover, due to the mentioned continuity, as $r \rightarrow 0$ the currents $C_r \llcorner E_\varepsilon^i$ are all homotopic to each other, and these homotopies keep the condition (2.5) between $C_r \llcorner E_\varepsilon^i$ and $\Sigma_p \llcorner E_\varepsilon^i$.

Therefore $k(C_r \llcorner E_\varepsilon^i, \Sigma_p)$ must stay constant as $r \rightarrow 0$, so there is a well-determined $N_i \in \mathbb{N}$ such that $k(C_r \llcorner E_\varepsilon^i, \Sigma_p) = N_i$. Then any limiting cone C_∞ must satisfy $k(C_\infty \llcorner E_\varepsilon^i, \Sigma_p) = N_i$, with the same proof as in lemma 2.2.2. This means that $C_\infty \llcorner E_\varepsilon^i = N_i D_i$, so all the multiplicities N_k are uniquely determined. □

2.3.2 Easy case of non-accumulation

. The following result solves the "easy case" of non-accumulation of singularities of multiplicity Q to a singularity p of the same multiplicity: this "easy case" arises when the tangent cone at p is not made of Q times the same disk. We will see how to handle the "difficult case" (tangent cone made of Q times the same plane) in sections 2.4 and 2.4.5.

Define the set $Sing^Q$ of singularities of multiplicity (or order) Q of the Special Legendrian cycle C :

$$Sing^Q := \{p \in C : p \text{ is a singular point, } \theta(p) = Q\}.$$

In the same fashion we will use the notation

$$Sing^{\leq Q} := \{p \in C : p \text{ is a singular point, } \theta(p) \leq Q\}.$$

Theorem 2.3.2. *For a Special Legendrian cycle C , assume $x_0 \in Sing^Q$, $T_{x_0}C \neq Q\llcorner[D]$, i.e. $T_{x_0}C = \bigoplus_{k=1}^m N_k D_k$, where D_k are distinct Special Legendrian disks and $m \geq 2$. Then $\exists r > 0$ such that*

$$Sing^Q \cap B_r(x_0) = \{x_0\}.$$

proof of theorem 2.3.2. The proof uses techniques similar to those from theorem 2.3.1. Take a normal chart with $x_0 = 0$: by contradiction, assume $\exists x_n \rightarrow 0$, with $x_n \in Sing^Q$. Rename the D_i 's so that D_1 and D_2 realize the minimum γ of the angular distances $\widehat{D_i, D_j}$. $\gamma > 0$ since $T_0C \neq Q\llcorner[D]$ and $\gamma \leq \frac{\pi}{2}$ since this is the maximum for the Fubini-Study metric.

Define $\rho_n = 2|x_n|$ and blow up about 0 using ρ_n as rescaling factors. Up to a possible exchange of the roles of D_1 and D_2 and up to a subsequence, we can assume $\frac{x_n}{2|x_n|} \rightarrow p \in D_2 \cap \partial B_{1/2}$. Rotate B_1 to ensure that D_1 and D_2 are contained in the $\frac{3\pi}{4}$ -cone around $D_0 \cong [1, 0]$ and that $\Sigma_p^{[0,1]}$ is transversal

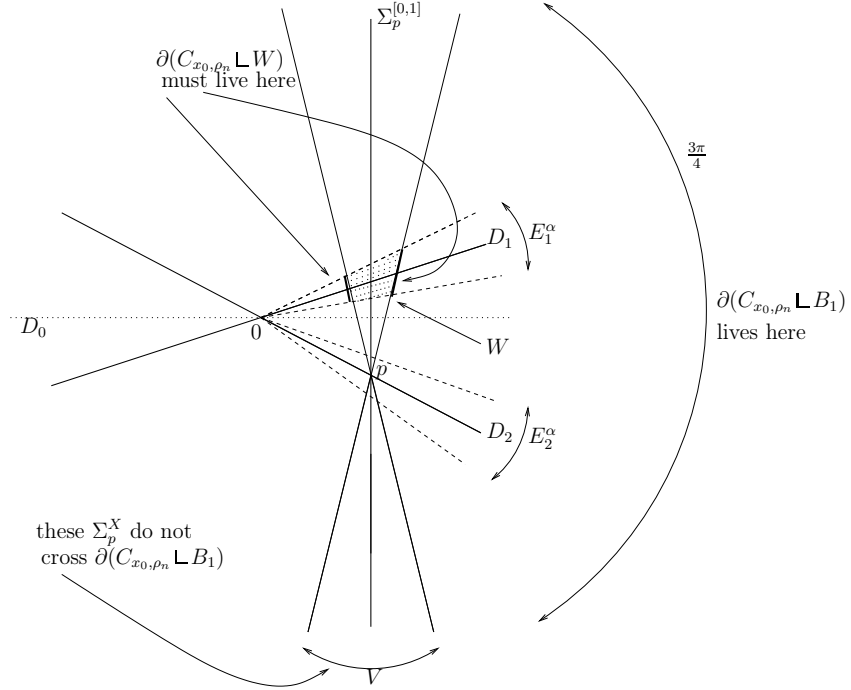

Figure 2.3: Situation inside the ball B_1 . To avoid confusion in the picture, we imagine that y_n coincides with p . The dotted region corresponds to W . *Heuristic idea of the proof:* any Σ_p^X , $X \in V$, should intersect C_{x_0, ρ_n} with multiplicity Q near p , since there we have a point of multiplicity Q . But there is mass of C_{x_0, ρ_n} in W and this portion must also give a strictly positive contribution to the intersection index of C_{x_0, ρ_n} and Σ_p^X . But now there is too much intersection.

to the disks $\{D_j\}_{j=1}^m$. The situation is schematically described in figure 2.3 (read the caption for some heuristics of the proof).

Take $\alpha \ll \gamma$; for all n large enough, thanks to lemma 2.3.3 we can ensure that

$$\text{spt}(C_{x_0, \rho_n} \llcorner B_1) \subset \cup_{i=1}^m E_i^\alpha \cup \{0\}, \quad (2.7)$$

where E_i^α denotes the cone of width α around D_i . Thanks to the position of D_1 and D_2 , we can find a small enough ball $U \subset \mathbb{C}\mathbb{P}^1$ centered at $[0, 1]$ such that for any $X \in U$ we have that Σ_p^X is transversal to the disks $\{D_j\}_{j=1}^m$ and that $\Sigma_p^X \cap \text{spt}(\partial(C_{x_0, \rho_n} \llcorner B_1)) = \emptyset$.

In this situation, thanks to lemma 2.2.2, we know that for $X \in U$ and for all large enough n

$$k(C_{x_0, \rho_n} \llcorner B_1, \Sigma_p^X) = k(T_{x_0} C, \Sigma_p^X) = \sum_{j=1}^n N_j k(D_j, \Sigma_p^X) \leq Q. \quad (2.8)$$

Let V be a ball strictly smaller than U with the same center and define

$$W := E_1^\alpha \cap (\cup_{X \in V} \Sigma_p^X).$$

At each y_n choose an open ball $V_n \subset \mathbb{C}\mathbb{P}^1 \cong \mathbb{P}H_{y_n}^4$ so that, for $n \geq n_0$ large enough,

(i) $\forall X \in V_n$ we have that $\Sigma_{y_n}^X$ is transversal to the disks $\{D_j\}_{j=1}^m$ and that $\Sigma_{y_n}^X \cap \text{spt}(\partial(C_{x_0, \rho_n} \llcorner B_1)) = \emptyset$;

(ii) setting $W_n := E_1^\alpha \cap (\cup_{X \in V_n} \Sigma_{y_n}^X)$, it holds $W \subset \cap_{n \geq n_0} W_n$.

Properties (i) and (ii) can of course be achieved for y_n close enough to p and V_n perturbations of V .

Thanks to the convergence $C_{x_0, \rho_n} \rightarrow T_{x_0} C \ni D_1$, we can ensure that for all n large enough

$$C_{x_0, \rho_n} \llcorner W \neq 0,$$

which trivially implies $C_{x_0, \rho_n} \llcorner W_n \neq 0$. W_n is foliated by $\cup_{X \in V_n} \Sigma_{y_n}^X$ and $\partial(C_{x_0, \rho_n} \llcorner W_n) \subset \cup_{X \in \partial V_n} \Sigma_{y_n}^X$ by (2.7). Then by lemma 2.3.1 we have that, for all $Y \in V_n$,

$$k(C_{x_0, \rho_n} \llcorner W_n, \Sigma_{y_n}^Y) \geq 1.$$

On the other hand, recalling remark 2.2.2, for ε small enough it must hold $k(C_{x_0, \rho_n} \llcorner B_\varepsilon(y_n), \Sigma_{y_n}^Y) = Q$ for all but finitely many Y 's (we only have to exclude the Y 's that build up $T_{y_n} C$). Since $W_n \cap B_\varepsilon(y_0) = \emptyset$, we get

$$k(C_{x_0, \rho_n} \llcorner B_1, \Sigma_{y_n}^Y) \geq Q + 1$$

But then

$$k(C_{x_0, \rho_n} \llcorner B_1, \Sigma_p^Y) \geq Q + 1$$

by homotopy (by (i) and (ii) we do not cross the boundary of $C_{x_0, \rho_n} \llcorner B_1$ during the homotopy). This contradicts (2.8). \square

2.3.3 Relative Lipschitz-type estimate

. The following theorem still uses the same ideas and will be of central importance for treating the more delicate case of a singular point p having a tangent cone that is Q times the same plane. We can without loss of generality assume that the plane involved is $D_0 \cong [1, 0]$. The result shows the "continuous behaviour" of tangent cones at points of multiplicity Q as they approach p (see figure 2.6 in the next section).

Theorem 2.3.3. *Let x_0 be a singular point of order Q of a Special Legendrian cycle, $x_0 \in \text{Sing}^Q$, with $T_{x_0}C = Q[[D_0]]$. Then $\forall \{y_n\} \rightarrow x_0$ sequence of points having multiplicity Q , the following holds:*

$$T_{y_n}C \rightarrow Q[[D_0]].$$

Remark 2.3.2. The convergence in the statement can of course be understood in the Flat-sense for currents in the tangent bundle and what we are proving is:

$$\forall \varepsilon \exists \delta \text{ s.t. } |x - x_0| < \delta \text{ and } \theta(x) = Q \Rightarrow \mathcal{F}((T_x C - Q[[D_0]]) \llcorner B_1(x_0)) < \varepsilon.$$

We give however a more concrete definition in terms of "angles" between the disks.

We are going to speak of "the angle between D_0 and D_p " although these disks may lie in the horizontal hyperplanes at different points. More precisely: let $D_0 \subset H_{x_0}^4$ and $D_p \subset H_p^4$ be holomorphic disks for the respective J-structures. Then we can define $\widehat{D_p, D_0}$ after identifying the two hyperplanes according to the coordinates induced by the first parallel foliation, see (2.2) in section 2.1 (we can assume, without loss of generality $x_0 = (1, 0, 0)$), and taking the distance in the Fubini-Study metric. The convergence in the theorem above amounts of course to the fact that the angles between D_0 and the disks of $T_{x_n}C$ go to 0.

In the same fashion we will speak of $\widehat{\Sigma_p^X, D_0}$ for some 3-surface born at p , meaning the angle between X and D_0 as just explained.

proof of theorem 2.3.3. Work in a normal chart centered at x_0 . Assume, by contradiction, that there exists $\{y_n\} \rightarrow 0$ such that $T_{y_n}C \not\rightarrow Q[[D_0]]$. Take as rescaling factors $\rho_n = 2|y_n|$ and blow up about 0. Denote $x_n = \frac{y_n}{2|y_n|}$ and keep denoting $\bigoplus_{i=1}^Q D_n^i$ the tangent disks at x_n . Now, up to a subsequence, for some $\alpha > 0$, $\widehat{D_n^i, D_0} \geq \alpha > 0$ and $x_n \in \partial B_{1/2}$ hold for all n . Choose $\varepsilon \ll \alpha$ such that $E_0^\varepsilon \cap \partial B_1$ is disjoint from any Σ_p of the set $\{\Sigma_p \mid p \in E_0^\varepsilon \cap \partial B_{1/2}, \widehat{\Sigma_p, D_0} \geq \frac{\alpha}{2}\}$, see figure 2.4. For a large enough n

- (i) $C_{x_0, \rho_n} \llcorner B_1 \subset E_0^\varepsilon \cup \{0\}$ by lemma 2.3.3,
- (ii) $k(C_{x_0, \rho_n} \llcorner B_1, \Sigma_q) = Q \quad \forall \Sigma_q$ with $\widehat{\Sigma_q, D_0} \geq \frac{\alpha}{2}$ and $q \in D_0 \cap B_{3/4}(0)$ by lemma 2.2.2 and remark 2.2.2.

Notational remark: the n fulfilling (i) and (ii) is chosen once for all. Therefore we are going to drop, in the rest of this proof, the index n from all the objects related to x_n , in particular we will denote by x the point x_n itself, by $T_x C = T_x C_{x_0, \rho_n} = \bigoplus_{i=1}^m N_i D_x^i$ (the total multiplicity is Q) the tangent cone at x_n and by Σ_x^i the 3-surface born at x_n and containing D_x^i . Moreover, since the theorem is local, it is enough to look just at the dilated current $C_{x_0, \rho_n} \llcorner B_1(0)$: by an abuse of notation we will write, during this proof, C instead of $C_{x_0, \rho_n} \llcorner B_1(0)$.

From the contradiction assumption, at least for one index l , $\widehat{D_x^l, D_0}$ is greater than a positive number very close to α .

Observe now the following: Take $\beta \ll \min_{i \neq j} \{\alpha, \widehat{D_x^i, D_x^j}\}$. Consider the cone $E_{x,l}^\beta$ around Σ_x^l . It is not possible that $\text{spt}(C \llcorner E_{x,l}^\beta) \subset \Sigma_x^l$: indeed, this would imply that the current $C \llcorner E_{x,l}^\beta$ must escape the barrier E_0^ε (by remark 2.1.1, having no boundary in the interior of $E_{x,l}^\beta$, C would have to coincide with the Special Legendrian 2-sphere tangent to D_x^l), which contradicts lemma 2.3.3.

So take $p \in \text{spt} C \cap E_{x,l}^\beta$, $p \notin \Sigma_x^l$. Let $\Sigma_x^P = \Sigma_{x,p}$ be the 3-surface born at x going through p ; surely $\widehat{P, D_0} \geq \frac{3\alpha}{4}$. We are going to show now that, up to tilting Σ_x^P a bit, we can assume that it is transversal to C and the intersection is well-defined and non-zero.

Take $\delta \ll \widehat{D_x^l, \Sigma_{x,p}}$ and $r \ll \text{dist}(x, p)$ in such a way that (see figures 2.4 and 2.5)

- (iii) $k(C \llcorner B_r(x), \Sigma_{x,p}) = Q$ (possible by remark 2.2.2, since $\Sigma_{x,p}$ is transversal to $T_x C$),
- (iv) $C \llcorner B_r(x) \subset E_x^\delta \cup \{x\}$ (by lemma 2.3.3, with E_x^δ denoting the δ -conic neighbourhood of $T_x C$).

By homotopy (see the remark following lemma 2.2.2)

$$k(C \llcorner B_r(x), \Sigma_x^Y) = Q$$

for all but finitely many Y 's in a small ball around P in \mathbb{CP}^1 (the finitely many Y 's we have to exclude are those that are tangent to the disks D_x^i , so to ensure that Σ_x^Y is transversal to $T_x C$). The ball should be chosen small

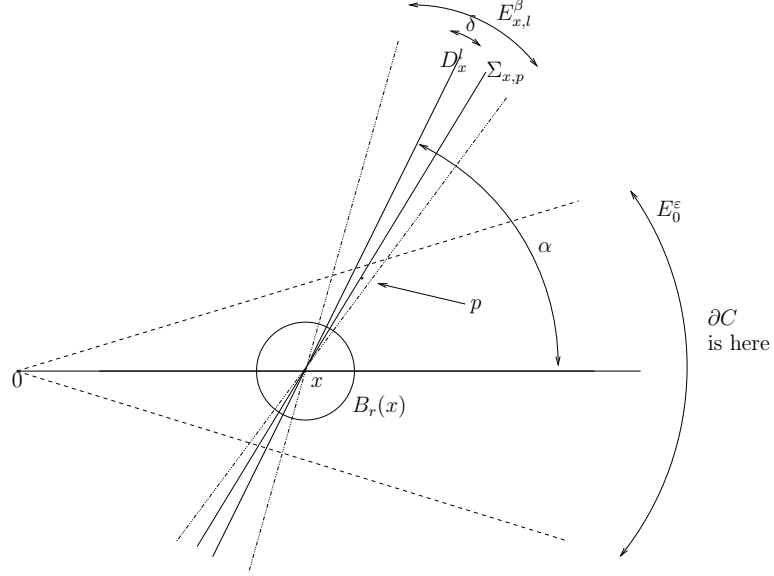

Figure 2.4: The objects involved: with C , as in the proof, we mean $C_{x_0, \rho_n} \llcorner B_1$.

enough so that $\widehat{Y, D_0} \geq \frac{\alpha}{2}$ and Σ_x^Y stays away from E_x^δ , so that these Σ_x^Y do not cross $\partial(C \llcorner B_r(x))$, see figure 2.5.

We are going to apply lemma 2.3.1:

$$W = (\cup_Y \Sigma_x^Y) \cap (B_1(x) \setminus \overline{B_r(x)})$$

is a foliated neighbourhood of p and we have boundary of C neither on $\overline{W} \cap \partial B_1$ (by (i)) nor on $\overline{W} \cap \partial B_r(x)$ (by (iv) and by the choice of the Y 's).

So, for the Y 's that we have chosen, if r is small enough, then

$$k(C, \Sigma_x^Y) = k(C \llcorner B_r(x), \Sigma_x^Y) + k(C \llcorner (B_1 \setminus B_r(x)), \Sigma_x^Y) \geq Q + 1.$$

But, by homotopy, going back to the standard notations, we find that $k(C_{x_0, \rho_n}, \Sigma_{x_n}^Y) = k(C_{x_0, \rho_n}, \Sigma_w^Y)$ for some $w \in D_0 \cap B_{3/4}(0)$ (identifying $\mathbb{P}H_{x_n}^4$ and $\mathbb{P}H_w^4$). So we have contradicted (ii). \square

The result just proved will be restated as a relative Lipschitz-type estimate (for the multi-valued graph describing the current) in corollary 2.4.1.

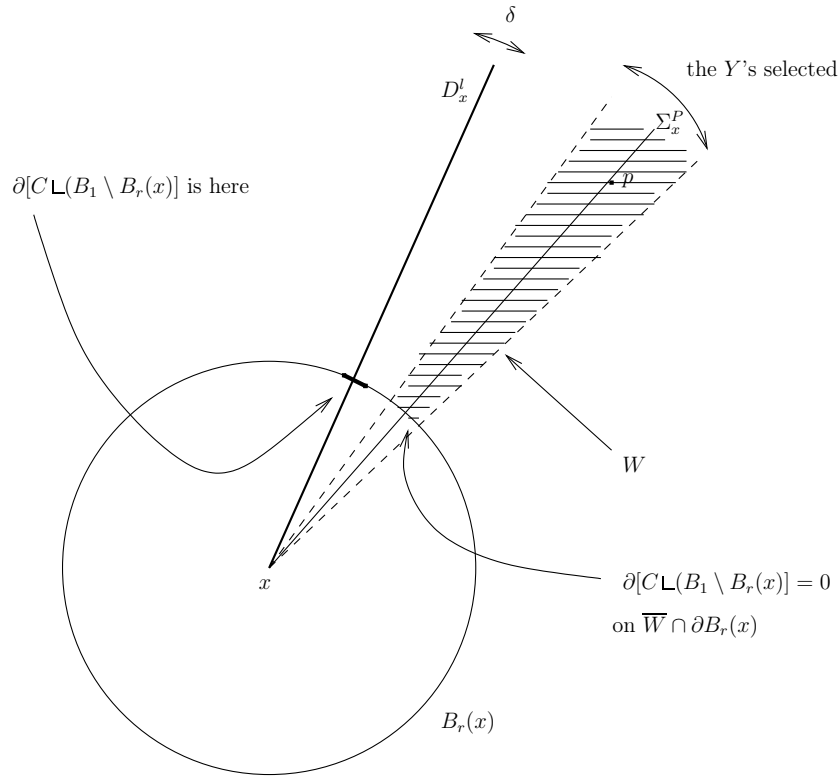

Figure 2.5: Magnify around x : selection of W (shaded region).

2.4 First part of the inductive step: high order singularities

Having established the previous results, in this section we start the proof of the regularity theorem 3.0.2, which will go on in the next sections.

2.4.1 Logical Structure of the proof

. The proof proceeds by induction. By the monotonicity formula, the multiplicity function is upper semi-continuous on the Special Legendrian C , therefore the set of points with multiplicity $\geq N$, for $N \in \mathbb{N}$ is closed in C . Then, to achieve our result, a singular point q with multiplicity Q being given, we only need to show that singular points of multiplicity $\leq Q$ cannot accumulate onto q . The idea is hence to prove this result by induction on the multiplicity Q : at each inductive step, we will assume that we are working in a neighbourhood where Q is the maximal multiplicity.

Basis of induction : $Q=1$ We are in an open set where all points of

the Special Legendrian C have multiplicity 1. Since C is minimal ($H = 0$) and boundaryless, we can deduce the smoothness in this set straight from Allard's theorem, see [53]. We can however provide a self-contained argument here: from theorem 2.3.3 we know that the tangent planes are continuous, therefore C is a C^1 current. A classical bootstrapping argument then leads to C^∞ regularity.

Assumptions for the inductive step : $\mathbf{Q-1} \Rightarrow \mathbf{Q}$. We are in an open ball B , where $Sing^Q$ is a closed set (that could a priori have positive \mathcal{H}^2 -measure) and $C \setminus Sing^Q$ is smooth except at the points $Sing^{\leq Q-1}$, which are isolated in the open set $C \setminus Sing^Q$.

We are going to divide the proof of the inductive step into two parts:

$\#_1$: $Sing^Q$ is made of isolated points in B , i.e. there is no possibility of accumulation of singularities of multiplicity Q to another singularity p of the same multiplicity;

$\#_2$: singularities of multiplicity $\leq Q-1$ cannot accumulate onto a singularity of multiplicity Q .

The proof of $\#_1$ will be achieved in the present section 2.4: we aim to prove

Theorem 2.4.1. *Let B^5 be a ball in which the highest multiplicity for the Special Legendrian cycle C is Q . Assume that $Sing^{\leq Q-1}$ is made of isolated points in $(C \llcorner B^5) \setminus Sing^Q$. Then the set $Sing^Q$ is made of isolated points in B^5 .*

Recall that there is an easy case of $\#_1$ that we already proved: indeed, for $p \in Sing^Q$ having a tangent cone that is not Q times the same disk, the result is just theorem 2.3.2.

Therefore we only need to prove $\#_1$ if the tangent cone at p is $Q[D]$. As explained in the introduction, theorem 2.4.1 will be achieved after having introduced a multi-valued graph that locally describes the Special Legendrian current. In suitable coordinates the branches of the multi-valued graph satisfy the elliptic system of PDEs (1.5), which is a perturbation of the classical Cauchy-Riemann. Thanks to a $W^{1,2}$ -regularity result for the average of the multi-valued graph, we will translate the issue of accumulation of singularities of multiplicity Q into a problem of accumulation of zeros for a new multi-valued graph whose branches solve a PDE that is still a perturbation of the classical Cauchy-Riemann. At this stage we will prove 2.4.1 by a unique continuation argument.

Here are the two foundational steps for the unique continuation:

- we find suitable coordinates in which the multi-valued graph satisfies the PDEs (1.5);
- we study the regularity of the average of the multi-valued graph, showing that it is $W^{1,2}$ on D^2 .

Once these steps will be achieved, the proof of \sharp_1 will come to an end with the unique continuation argument in subsection 2.4.5.

2.4.2 Choice of Coordinates

. We are now going to choose appropriate coordinates to guarantee later a $W^{1,2}$ -type estimate. In order to do that, we will need the result contained in the next lemma. First observe the following:

Remark 2.4.1. Due to the construction of Σ , given any 3-surface Σ_q^X and for any point $p \in \Sigma_q^X$, then $T_p(\Sigma_q^X) \cap H_p^4$ is a complex line in H_p^4 . This can be seen as follows: $T_p(\Sigma_q^X) \cap H_p^4$ is a two-dimensional subspace since Σ_q^X is transversal to H_p^4 ; moreover one of the Special Legendrian spheres foliating (and building up) Σ_q^X must go through p and it is tangent to H_p^4 .

Remark 2.4.2. In the construction of the 3-surfaces Σ_q^X performed in section 2.1, q was taken in a neighbourhood of the Special Legendrian 2-sphere L_0 . We can parametrize this neighbourhood of L_0 with a complex coordinate w such that the point $(1, 0, 0) \in L_0$ has coordinate 0. By abuse of notation we will also write Σ_w^X instead of Σ_q^X when the point $q \in L_0$ has coordinate w .

Lemma 2.4.1. *There exist open neighbourhoods V, U of $[0, 1]$ in \mathbb{CP}^1 so that we can define¹¹ the function:*

$d : B_1^5 \times V \rightarrow B_2^2 \times U$, given by $d(p, Y) = (w, X)$ s.t. Σ_w^X contains p and $Y \subset T_p \Sigma_w^X$. Moreover, d is of class C^1 .

In other words, for any point $p \in B_1^5$ and any almost vertical direction Y there exist a unique point $w \in L_0$ and direction X such that Σ_w^X goes through p with direction Y . Moreover this correspondence is C^1 .

proof of lemma 2.4.1. Take the following neighbourhood U of $[0, 1]$ in \mathbb{CP}^1 , $U = \{[Z; W] \in \mathbb{CP}^1 : |W| > 2|Z|\}$. Define the function

$$\tilde{w} : B_1^5 \times U \rightarrow B_2^2$$

where $\tilde{w} = \tilde{w}(p, X)$ is the point in $B_2^2 \cong L_0 \cap B_2^5$ such that $p \in \Sigma_{\tilde{w}}^X$ (\tilde{w} is uniquely defined since $\{\Sigma_w^X\}$ foliates B_1^5 as the base point runs over L_0). \tilde{w}

¹¹By B_1^5 we mean the 5-dimensional ball of radius 1. Analogously for B_2^2 , which we implicitly identify with the disk in \mathbb{C} of radius 2.

is a smooth function.

Recall remark 2.4.1. Denote by $\tilde{X} = \tilde{X}(p, X) \in \mathbb{C}\mathbb{P}^1$ the complex line¹² in H_p^4 such that \tilde{X} , as a 2-dimensional plane, is contained in the tangent to Σ_w^X at p . $\tilde{X}(p, X)$ is a smooth perturbation of X , since the contact structure in B_1^5 is a smooth perturbation of the integrable structure $\mathbb{C}^2 \times \mathbb{R}$. Consider

$$D : B_1^5 \times U \times B_2^2 \times U \rightarrow \mathbb{C} \times \mathbb{C}\mathbb{P}^1$$

$$D : (p, Y, w, X) \rightarrow (w - \tilde{w}(p, X), \tilde{X}(p, X) - Y).$$

The function D is C^1 and we can compute its (w, X) -differential

$$\frac{\partial D}{\partial(w, X)} = \begin{pmatrix} 1 & \frac{\partial \tilde{w}}{\partial X} \\ 0 & \frac{\partial \tilde{X}}{\partial X} \approx 1 \end{pmatrix}$$

and its determinant is non-zero, therefore, by the implicit function theorem, the set $\{D = 0\}$ can be described as a graph over $B_1^5 \times V$

$$(p, Y, d(p, Y))$$

for some $d \in C^1$ and $V \subset U$. The condition $D(p, Y, w, X) = 0$ expresses the fact that Σ_w^X goes through p with direction Y , thus d satisfies the statement of lemma 2.4.1. \square

Before starting the proof of non-accumulation of singularities of order Q to a singular point x_0 having tangent cone of the form $Q[[D]]$, we are going to set coordinates so that the current and the leaves of the chosen foliation Σ^X have only isolated and at most countably many points of non-transversality.

Recall that a parallel foliation $\{\Sigma_p^X\}$ for X fixed, of the type constructed in section 2.1, locally induces a system of 5 real coordinates around $x_0 = (1, 0, 0)$, the first two, (s, t) , lying in the space of parameters L_0 (the chosen Special Legendrian 2-sphere) and the remaining three in Σ , see lemma 2.1.2 and the discussion about families of parallel foliations. We can also think of having a complex coordinate on $L_0 \cap B_2^5 \cong B_2^2$ rather than two real ones. This means, for instance, that in this coordinates, if $q \in L_0$ has coordinate $z_0 \in \mathbb{C}$, the leaf Σ_q^X is described by $\{(z_0, b, c, a)\}$, as (b, c, a) describes to $B_2^3 \subset \mathbb{R}^3$. In the same vein, L_0 is described by $\{(z, 0, 0, 0)\}$ or by $\{(s, t, 0, 0, 0)\}$, where we used respectively a complex and two real coordinates for $L_0 \cap B_2^5 \cong B_2^2$.

In the coordinates so induced by $\{\Sigma_p^X\}$, introduce the projection map $\pi : B_2^2 \times B_2^3 \rightarrow B_2^2$ sending (z, b, c, a) to z .

Now we want to choose a privileged direction X to ensure the transversality announced above. Recall that we are working in a neighbourhood of x_0

¹²Recall that $\mathbb{C}\mathbb{P}^1 \cong \mathbb{P}H_p^4$.

where the multiplicity is everywhere $\leq Q$. Start with coordinates set in such a way that $x_0 = 0$, $D = D_0 \cong [1, 0]$ and the foliation we are using is given by $\{\Sigma_p^{[0,1]}\}$, and assume that we have blown up enough in order to ensure that $\text{spt}(C_{0,r} \llcorner B_1) \subset E^\delta \cup \{0\}$ for some small δ (lemma 2.3.3) and that $T_y C_{0,r}$ makes an angle smaller than δ for any $y \in \text{Sing}^Q$ (theorem 2.3.3).

Recall lemma 2.4.1 and let S be the smooth part of the current $C_{0,r}$ where the tangent planes are in V . Denote by π_2 the projection $\pi_2 : B_2^2 \times U \rightarrow U$. Define the following function $\psi : S \rightarrow \mathbb{C}\mathbb{P}^1$

$$\psi(p) := \pi_2(d(p, T_p S)).$$

The tangent on S is a smooth function, thus, by composition, ψ is also smooth. Therefore we can find a regular value X for ψ as close as we want to $[0, 1]$. We choose then the coordinates induced by this Σ^X , which we will denote by $\{(z, b, c, a)\}$ or by $\{(s, t, b, c, a)\}$, where $z = s + it$. They have the property that the leaves Σ_z^X are tangent to the smooth part of the current only at isolated points $\{t_i\}_{i=1}^\infty$ (they can possibly accumulate on the singular set). As for the singular set, the points of multiplicity up to $Q - 1$ are also isolated singularities by inductive assumption, so we can assume that there is transversality there up to picking a new X , again among the regular values (only a countable set of X must be avoided). On the set Sing^Q the tangent cone makes a small angle with the horizontal, thanks to the Lipschitz estimate from theorem 2.3.3.

2.4.3 Multi-valued graph

. With the coordinates just taken, denote by π the projection onto $D_0 \cong \{(z, 0, 0)\}$. Recall that we are also assuming to have dilated the current about 0 of a factor r small enough to ensure that $C_r := C_{0,r} \llcorner B_1$ has support δ -close to $T_0 C$ and that $T_y C_r$ makes an angle smaller than δ with $T_0 C$ for any $y \in \text{Sing}^Q$.

We can now say that, by intersection theory, except on the countable set $\{\pi(t_i)\}$, the leaves intersect C transversally and positively; as explained in remark 2.2.2, for some $R < 1$, Σ_z^X intersect the current at exactly Q points (counted with multiplicities) for a.e. $|z| < R$. We have thus defined a Q -valued function

$$\{b_i, c_i, \alpha_i\}_{i=1}^Q(z) : D_R \rightarrow \mathbb{R}^3, \text{ or}$$

$$\{\varphi_i, \alpha_i\}_{i=1}^Q(z) : D_R \rightarrow \mathbb{C} \times \mathbb{R},$$

with $D_R = \{(z, 0, 0), |z| < R\}$, $\varphi_j = b_j + ic_j$. Equivalently, we have a function

from D_R into the Q -th symmetric product

$$\mathcal{S}^Q(\mathbb{C} \times \mathbb{R}) = \frac{(\mathbb{C} \times \mathbb{R})^Q}{\sim},$$

where two Q -tuples are equivalent if one is a permutation of the other. When using the notation $\{\varphi_i, \alpha_i\}_{i=1}^Q$ it should be kept in mind that the Q -tuples are *unordered*, so the indexation is not global on D_R .

The Q -valued function just constructed is L^∞ since the current is contained in a cone $E^{2\delta}$ around D_R .

Remark 2.4.3. Introduce the following notation:

$$\mathcal{A} = D_R \setminus \pi(\text{Sing}^Q), \quad \mathcal{B} = \mathcal{A} \setminus \pi(\text{Sing}^{\leq Q-1}), \quad \mathcal{G} = \mathcal{B} \setminus \bigcup_{i=1}^\infty \{\pi(t_i)\}.$$

$\pi(\text{Sing}^Q)$ is a closed set since we are working in a neighbourhood where Q is the highest multiplicity and thanks to the inductive hypothesis, therefore \mathcal{A} is open. $\mathcal{B} = D_R \setminus \pi(\text{Sing}^{\leq Q})$ is also open since $\text{Sing}^{\leq Q}$ is a closed set. \mathcal{G} is open since we are taking away from the open set \mathcal{B} a countable set of isolated points that can only accumulate on the complement of \mathcal{B} .

Observe that, locally on \mathcal{B} , it is possible to give a coherent global indexation of $\{\varphi_i, \alpha_i\}_{i=1}^Q$; i.e., for any point in \mathcal{B} there is a small ball centered at this point on which the multifunction is made of Q distinct smooth functions.

2.4.4 PDEs and Average

Define the average of the branches $\{\varphi_i, \alpha_i\}_{i=1}^Q$ by

$$\tilde{\Psi} = (\tilde{\varphi}, \tilde{\alpha}) := \left(\frac{\sum_{i=1}^Q \varphi_i}{Q}, \frac{\sum_{i=1}^Q \alpha_i}{Q} \right),$$

which is a single-valued L^∞ function on D_R . The next steps aim to prove that this average is actually a $W^{1,2}$ function. This will be achieved with theorem 2.4.2. The strategy is as follows:

- after writing the PDEs satisfied by the branches of the Q -valued function at smooth points, we will estimate that the $W^{1,2}$ -norm on \mathcal{G} is finite and bounded by the mass of the current;
- we will successively extend the estimate to \mathcal{B} and \mathcal{A} by using the fact that, in dimension two, the $W^{1,2}$ -capacity of an isolated point is zero;
- eventually, thanks to theorem 2.3.3, we will conclude that $(\tilde{\varphi}, \tilde{\alpha})$ is $W^{1,2}$ on the whole of D_R .

PDEs As noted above, on the open set \mathcal{G} the branches $\{\varphi_i, \alpha_i\}_{i=1}^Q$ are locally smooth functions. We restrict ourselves to a small ball $\Delta \subset \mathcal{G}$ on which they can be globally indexed and we are going to write the PDEs satisfied by these Q functions coming from the fact that these (smooth) pieces are calibrated by ω . Notice that also the derivatives of the Q branches are well-defined functions. We are using coordinates $(z, \zeta, a) = (s, t, b, c, a)$, where $z = s + it, \zeta = b + ic$ are complex and the others real. Recall that Σ were built so that the coordinate vectors $\frac{\partial}{\partial b}$ and $\frac{\partial}{\partial c}$ are always tangent to the 4-planes H^4 of the horizontal distribution. Denote by J the J-structure defined on these hyperplanes,

$$J_p : H_p^4 \rightarrow H_p^4.$$

We can assume that each leaf Σ_z is parametrized in such a way that

$$J\left(\frac{\partial}{\partial b}\right) = \frac{\partial}{\partial c}, \quad J\left(\frac{\partial}{\partial c}\right) = -\frac{\partial}{\partial b}. \quad (2.9)$$

Recall that we are assuming, without loss of generality, that the origin of $D_R \times \mathbb{R}^3$ corresponds to the point $(1, 0, 0) \in \mathbb{C}^3$ (this can be done by rotating S^5 via a rotation in $SU(3)$). We also assume that (s, t) are such that $\frac{\partial}{\partial s}$ and $\frac{\partial}{\partial t}$ coincide respectively with $\frac{\partial}{\partial x^2}$ and $\frac{\partial}{\partial x^3}$ in \mathbb{C}^3 at the point 0, so $\omega(0) = dx^2 \wedge dx^3 - dy^2 \wedge dy^3$ as a form in \mathbb{C}^3 is $ds \wedge dt + db \wedge dc$ in the new coordinates. Moreover,

$$\frac{\partial}{\partial b}, \frac{\partial}{\partial c}, \frac{\partial}{\partial a} \text{ are always orthogonal to each other,}$$

$$\frac{\partial}{\partial b}, \frac{\partial}{\partial c} \text{ are also orthogonal to the unit fiber vector } v \text{ (} v = i \frac{\partial}{\partial r} \text{ in } \mathbb{C}^3 \text{)}.$$

All the other scalar products of the¹³ coordinate vectors $\frac{\partial}{\partial s}, \frac{\partial}{\partial t}, \frac{\partial}{\partial b}, \frac{\partial}{\partial c}, \frac{\partial}{\partial a}$ at a point p are bounded by $K \varepsilon$, for an arbitrarily small ε , as long as we blow-up of a factor r small enough, since they are orthogonal at the point 0 and the structure is smooth.

Analogously, since the fiber vector at 0 is also equal to $\frac{\partial}{\partial a}$ and orthogonal to $\frac{\partial}{\partial s}, \frac{\partial}{\partial t}$, we have

$$-K \varepsilon \leq \langle \frac{\partial}{\partial s}, v \rangle, \langle \frac{\partial}{\partial t}, v \rangle, \langle \frac{\partial}{\partial s}, \frac{\partial}{\partial a} \rangle, \langle \frac{\partial}{\partial t}, \frac{\partial}{\partial a} \rangle \leq K \varepsilon. \quad (2.10)$$

Further, with $\omega_r := \frac{1}{r^2}((rx)^*(\omega))$, for any l we have that $\|\omega_r - \omega(0)\|_{C^l(B_1)} \rightarrow 0$ as $r \rightarrow 0$. Remark that ω_r calibrates the blown-up current C_r .

¹³Throughout the section, K will always represent a constant independent of the chosen $\Delta \subset D_R$.

As we said before, each branch $\Psi_j = (\varphi_j, \alpha_j)$ is a well-defined graph on Δ . We can focus on one precise branch, for a certain $j \in \{1, \dots, Q\}$: the parametrization of this smooth piece is

$$\Lambda_j(s, t) := (s, t, b_j(s, t), c_j(s, t), \alpha_j(s, t)),$$

with tangent vectors

$$\frac{\partial \Lambda_j}{\partial s} = \left(1, 0, \frac{\partial b_j}{\partial s}, \frac{\partial c_j}{\partial s}, \frac{\partial \alpha_j}{\partial s} \right), \quad \frac{\partial \Lambda_j}{\partial t} = \left(0, 1, \frac{\partial b_j}{\partial t}, \frac{\partial c_j}{\partial t}, \frac{\partial \alpha_j}{\partial t} \right). \quad (2.11)$$

On each tangent space $T_p S^5$ extend J to a linear map defined on the whole of $T_p S^5$

$$J : T_p S^5 \rightarrow T_p S^5,$$

by setting $J \left(\frac{\partial}{\partial a} \right) = \frac{\partial}{\partial a}$ (this is quite arbitrary). Introduce the following notation for the coefficient of this map in the given basis:

$$J \left(\frac{\partial}{\partial s} \right) = \varsigma \frac{\partial}{\partial s} + \lambda \frac{\partial}{\partial t} + \eta \frac{\partial}{\partial a} + \beta \frac{\partial}{\partial b} + \gamma \frac{\partial}{\partial c},$$

where $\varsigma, \eta, \beta, \gamma$ are small in modulus, say less than some $K \cdot r$ since they are equal to 0 at the point 0, while $|\lambda|$ is close to 1. These five functions depend on the variables (s, t, b, c, a) , but we will not explicitly write this dependence. For the other coefficients of J , recall (2.9) and the extension of J done above. The condition of being a Special Legendrian expressed by proposition 2 is then given by the two relations valid at any point:

$$\frac{\partial \Lambda_j}{\partial s} \wedge \frac{\partial \Lambda_j}{\partial t} \subset H^4, \quad (2.12)$$

$$J \left(\frac{\partial \Lambda_j}{\partial s} \right) = \lambda \frac{\partial \Lambda_j}{\partial t} + \varsigma \frac{\partial \Lambda_j}{\partial s}. \quad (2.13)$$

The fact that the last two coefficients must be exactly λ and ς will be clear in a moment. We explicit now (2.13), using (2.11):

$$\begin{aligned} J \left(\frac{\partial \Lambda_j}{\partial s} \right) &= \varsigma \frac{\partial}{\partial s} + \lambda \frac{\partial}{\partial t} + \eta \frac{\partial}{\partial a} + \beta \frac{\partial}{\partial b} + \gamma \frac{\partial}{\partial c} + \frac{\partial b_j}{\partial s} \frac{\partial}{\partial c} - \frac{\partial c_j}{\partial s} \frac{\partial}{\partial b} + \frac{\partial \alpha_j}{\partial s} \frac{\partial}{\partial a} = \\ &= \lambda \frac{\partial \Lambda_j}{\partial t} + \varsigma \frac{\partial \Lambda_j}{\partial s} = \\ &= \lambda \left(\frac{\partial}{\partial t} + \frac{\partial b_j}{\partial t} \frac{\partial}{\partial b} + \frac{\partial c_j}{\partial t} \frac{\partial}{\partial c} + \frac{\partial \alpha_j}{\partial t} \frac{\partial}{\partial a} \right) + \varsigma \left(\frac{\partial}{\partial s} + \frac{\partial b_j}{\partial s} \frac{\partial}{\partial b} + \frac{\partial c_j}{\partial s} \frac{\partial}{\partial c} + \frac{\partial \alpha_j}{\partial s} \frac{\partial}{\partial a} \right) \end{aligned} \quad (2.14)$$

(from comparing the coefficients of $\frac{\partial}{\partial s}$ and $\frac{\partial}{\partial t}$ we can see why we needed λ and ς in (2.13)). Identifying the coefficients of the coordinate vectors $\frac{\partial}{\partial b}$ and $\frac{\partial}{\partial c}$ in the first and third line of (2.14) leads to

$$\begin{cases} -\frac{\partial c_j}{\partial s} + \beta = \lambda \frac{\partial b_j}{\partial t} + \varsigma \frac{\partial b_j}{\partial s}, \\ \frac{\partial b_j}{\partial s} + \gamma = \lambda \frac{\partial c_j}{\partial t} + \varsigma \frac{\partial c_j}{\partial s}. \end{cases} \quad (2.15)$$

Substituting the expression for $\frac{\partial c_j}{\partial s}$ given by the first line of (2.15) into the second we get

$$\frac{\partial b_j}{\partial s} = \lambda \frac{\partial c_j}{\partial t} + \varsigma \left(\beta - \lambda \frac{\partial b_j}{\partial t} - \varsigma \frac{\partial b_j}{\partial s} \right) - \gamma,$$

which implies

$$\frac{\partial b_j}{\partial s} = \frac{\lambda}{1 + \varsigma^2} \left(\frac{\partial c_j}{\partial t} - \varsigma \frac{\partial b_j}{\partial t} + \frac{\varsigma \beta - \gamma}{\lambda} \right). \quad (2.16)$$

Plugging this back into the first identity of (2.15) we get

$$\frac{\partial c_j}{\partial s} = -\frac{\lambda}{1 + \varsigma^2} \left(\frac{\partial b_j}{\partial t} + \varsigma \frac{\partial c_j}{\partial t} - \frac{\beta + \varsigma \gamma}{\lambda} \right). \quad (2.17)$$

Let us now draw some conclusions from (2.12). We have to impose that $\frac{\partial \Lambda_j}{\partial s}$ and $\frac{\partial \Lambda_j}{\partial t}$ are always orthogonal to the vertical fiber vector v . Since the first two components of $\frac{\partial \Lambda_j}{\partial s}$ are fixed and equal $(1, 0)$ and $\frac{\partial}{\partial b}, \frac{\partial}{\partial c}$ are orthogonal to v , (2.12) means

$$\left\langle \frac{\partial}{\partial s}, v \right\rangle = -\frac{\partial \alpha_j}{\partial s} \left\langle \frac{\partial}{\partial a}, v \right\rangle. \quad (2.18)$$

Doing the same with $\frac{\partial \Lambda_j}{\partial t}$ we obtain

$$\left\langle \frac{\partial}{\partial t}, v \right\rangle = -\frac{\partial \alpha_j}{\partial t} \left\langle \frac{\partial}{\partial a}, v \right\rangle. \quad (2.19)$$

Since $\left\langle \frac{\partial}{\partial a}, v \right\rangle$ is close to 1 (see (2.10)), we get

$$\left| \frac{\partial \alpha_j}{\partial s} \right|, \left| \frac{\partial \alpha_j}{\partial t} \right| \leq K \varepsilon. \quad (2.20)$$

We can rewrite¹⁴ equations (2.16), (2.17), (2.18) and (2.19) as

¹⁴Recall again that we are focusing on a chosen branch $\Psi_j = (b_j, c_j, \alpha_j)$, which describes a smooth piece of the multi-valued graph above Δ .

$$\begin{cases} \frac{\partial b_j}{\partial s} = A \frac{\partial c_j}{\partial t} + B \frac{\partial b_j}{\partial t} + C \\ \frac{\partial c_j}{\partial s} = -A \frac{\partial b_j}{\partial t} + B \frac{\partial c_j}{\partial t} + F \\ \nabla \alpha_j = h(s, t, \Psi_j) . \end{cases} \quad (2.21)$$

Here A, B, C, F are smooth real functions of $(s, t, b_j(s, t), c_j(s, t), \alpha_j(s, t))$ with $A(0, 0, 0, 0, 0) = 1$, $B(0, 0, 0, 0, 0) = C(0, 0, 0, 0, 0) = F(0, 0, 0, 0, 0) = 0$, so A is close to 1 and B, C, F are less than ε in modulus¹⁵. The \mathbb{R}^2 -valued function h is Lipschitz thanks to (2.20).

Complex PDE. We are going to rewrite the first two equations in (2.21) in complex form, so we use the complex coordinate $z = s + it$, and observe the function $\varphi_j(z) = b_j(s, t) + ic_j(s, t)$. The complex derivatives $\frac{\partial}{\partial z} = \frac{1}{\sqrt{2}} \left(\frac{\partial}{\partial s} - i \frac{\partial}{\partial t} \right)$ and $\frac{\partial}{\partial \bar{z}} = \frac{1}{\sqrt{2}} \left(\frac{\partial}{\partial s} + i \frac{\partial}{\partial t} \right)$ will be denoted respectively by ∂ and $\bar{\partial}$. Compute the first equation in (2.21) plus i times the second:

$$\frac{\partial \varphi_j}{\partial s} = (-iA + B) \frac{\partial \varphi_j}{\partial t} + C + iF.$$

Then

$$\begin{cases} \sqrt{2} \bar{\partial} \varphi_j = ((1 - A)i + B) \frac{\partial \varphi_j}{\partial t} + C + iF, \\ \sqrt{2} \partial \varphi_j = -(1 + A)i + B) \frac{\partial \varphi_j}{\partial t} + C + iF. \end{cases} \quad (2.22)$$

We seek a function $\nu = \nu_1 + i\nu_2$ so that

$$(1 - A)i + B = -(\nu_1 + i\nu_2)(-(1 + A)i + B),$$

which rewrites, separating imaginary and real parts:

$$\begin{pmatrix} 1 + A & -B \\ B & 1 + A \end{pmatrix} \begin{pmatrix} \nu_1 \\ \nu_2 \end{pmatrix} = \begin{pmatrix} 1 - A \\ -B \end{pmatrix}.$$

The matrix on the l.h.s. is a perturbation of $2 Id$, and the vector on the r.h.s. has norm bounded by ε , therefore we can invert the system and find that there is a unique solution for $\nu = \nu_1 + i\nu_2$ whose norm is bounded by ε . Then, setting $\mu = \frac{1}{\sqrt{2}}(1 + \nu)(C + iF)$ we can write, from (2.22),

$$\bar{\partial} \varphi_j + \nu(z, \varphi_j, \alpha_j) \partial \varphi_j + \mu(z, \varphi_j, \alpha_j) = 0, \quad (2.23)$$

¹⁵ ε is a positive number which can be assumed as small as we wish: it is of order r , the rescaling factor that we used for the blow-up.

with $\nu, \mu : \mathbb{C}_z \times \mathbb{C}_\zeta \times \mathbb{R}_a \rightarrow \mathbb{C}$ smooth functions, $\nu(0) = \mu(0) = 0$, $|\nu|, |\mu| \leq \varepsilon$.

The first two equations in (2.21), or equivalently equation (2.23), are perturbations of the classical Cauchy-Riemann equations. Notice however that the coefficients depend on $s, t, b_j(s, t), c_j(s, t)$ and $\alpha_j(s, t)$, and we need the third equation in (2.21), to clarify the " α -dependence".

At this stage, we can estimate the L^2 -norm of the jacobian of Ψ_j using (2.16), (2.17) and (2.20). Recall that the functions $\varsigma, \eta, \beta, \gamma$ are in modulus smaller than $K\varepsilon$ and λ is close to 1. The metrics in the base space $\Delta_{s,t}$ and in the target $\mathbb{R}_{b,c,a}^3$ are perturbation of the standard euclidean metrics (at 0 they coincide with them), so

$$\begin{aligned} |D\Psi_j|^2 &\leq K \left(\left| \frac{\partial b_j}{\partial s} \right|^2 + \left| \frac{\partial b_j}{\partial t} \right|^2 + \left| \frac{\partial c_j}{\partial s} \right|^2 + \left| \frac{\partial c_j}{\partial t} \right|^2 + \left| \frac{\partial \alpha_j}{\partial s} \right|^2 + \left| \frac{\partial \alpha_j}{\partial t} \right|^2 \right) \leq \\ &\leq K \left(\left| \frac{\partial b_j}{\partial t} \right|^2 + \left| \frac{\partial c_j}{\partial t} \right|^2 + C\varepsilon^2 \right) + K\varepsilon^2 \leq K \left(1 + \left| \frac{\partial b_j}{\partial t} \right|^2 + \left| \frac{\partial c_j}{\partial t} \right|^2 \right). \end{aligned} \quad (2.24)$$

The constant K obtained at the end only depends on the factor r that we used for the dilation and is valid for any smaller r , moreover it is independent of the chosen Δ . We can assume that $K = 2$, since this constant gets closer to 1 as $r \rightarrow 0$.

$W^{1,2}$ estimate for the average. For $\Psi_j = (b_j, c_j, \alpha_j)$ (we are still focusing, locally on Δ , on a single smooth branch), consider $(\Psi_j)^* \omega_0 = \left(1 + \frac{\partial b_j}{\partial s} \frac{\partial c_j}{\partial t} - \frac{\partial b_j}{\partial t} \frac{\partial c_j}{\partial s} \right) ds \wedge dt$ and plug in (2.16) and (2.17):

$$\begin{aligned} (\Psi_j)^* \omega_0 &\geq 1 + \frac{\lambda}{1 + \varsigma^2} \left(\frac{\partial c_j}{\partial t} \right)^2 + \frac{\lambda}{1 + \varsigma^2} \left(\frac{\partial b_j}{\partial t} \right)^2 - \varepsilon \left| \frac{\partial b_j}{\partial t} \frac{\partial c_j}{\partial t} \right| - \varepsilon \left| \frac{\partial b_j}{\partial t} \right| - \varepsilon \left| \frac{\partial c_j}{\partial t} \right| \geq \\ &\geq \frac{1}{2} \left(1 + \left| \frac{\partial b_j}{\partial t} \right|^2 + \left| \frac{\partial c_j}{\partial t} \right|^2 \right) \geq \frac{1}{4} (1 + |\nabla b_j|^2 + |\nabla c_j|^2), \end{aligned} \quad (2.25)$$

where we used $\varepsilon \left| \frac{\partial b_j}{\partial t} \frac{\partial c_j}{\partial t} \right| \leq \frac{1}{2} \left(\varepsilon \left(\frac{\partial b_j}{\partial t} \right)^2 + \varepsilon \left(\frac{\partial c_j}{\partial t} \right)^2 \right)$ and $\varepsilon \left| \frac{\partial c_j}{\partial t} \right| \leq \frac{1}{2} \left(\varepsilon + \varepsilon \left(\frac{\partial c_j}{\partial t} \right)^2 \right)$,

the hypothesis on $\varsigma, \eta, \beta, \gamma, \lambda$ and (2.24) with $K = 2$ as said above.

Consider now $\omega_r - \omega_0$. Write this 2-form in the canonical basis in the coordinates s, t, b, c, a . All the coefficients are smaller than ε in modulus, if r was chosen small enough. Therefore

$$(\Psi_j)^* (\omega_r - \omega_0)$$

is a 2-form in $ds \wedge dt$ whose coefficient comes from summing products of derivatives of Ψ_j . As above, we can bound this coefficient by $\varepsilon \left(1 + \left| \frac{\partial b_j}{\partial t} \right|^2 + \left| \frac{\partial c_j}{\partial t} \right|^2 \right)$. Using this fact, together with (2.25) and the triangle inequality we have

$$\int_{\Delta} (\Psi_j)^* \omega_r \geq \left(\frac{1}{4} - \varepsilon \right) \int_{\Delta} 1 + |\nabla b_j|^2 + |\nabla c_j|^2.$$

Recalling (2.24) we can finally write the desired estimate:

$$\int_{\Delta} |D\Psi_j|^2 \leq K \int_{\Delta} (\Psi_j)^* \omega_r = K \int_{\Psi_j(\Delta)} \omega_r = K \cdot \mathcal{H}^2(\Psi_j(\Delta)), \quad (2.26)$$

with a constant K independent of the chosen Δ . We can therefore conclude, recalling the notations taken during the inductive assumptions,

Lemma 2.4.2. *On the set $\mathcal{G} = (D_R \setminus \text{Sing}^{\leq Q}) \setminus \cup_{i=1}^{\infty} \{\pi(t_i)\}$ it holds*

$$\sum_{i=1}^Q \int_{\mathcal{G}} (|D\varphi_i|^2 + |D\alpha_i|^2) \leq K \cdot \mathcal{H}^2(C_r) < \infty$$

and therefore the average function $\tilde{\Psi} = (\tilde{\varphi}, \tilde{\alpha})$ is $W^{1,2}(\mathcal{G})$ with norm bounded by the mass of C_r (we already knew that it is L^∞).

The next considerations will allow us to extend this estimate for $(\tilde{\varphi}, \tilde{\alpha})$ to the set $\mathcal{B} = \mathcal{G} \cup_{i=1}^{\infty} \{\pi(t_i)\}$. One can do this in a straightforward way recalling that the capacity of a point in \mathbb{R}^2 is zero. Anyway we also give a direct proof. Rename for notational convenience $q_i = \pi(t_i)$ and take $B_{\rho_i}(q_i) \subset \mathcal{B}$ balls centered at the q_i 's so that $\sum_i \rho_i \leq \delta$, for δ chosen arbitrarily small. Let ξ be any test-function in $C_c^\infty(\mathcal{B})$. Then

$$\begin{aligned} \left| \int_{\mathcal{B}} \tilde{\varphi} \frac{\partial \xi}{\partial s} \right| &\leq \left| \int_{\cup_i B_{\rho_i}(q_i)} \tilde{\varphi} \frac{\partial \xi}{\partial s} \right| + \left| \int_{\mathcal{B} \setminus \cup_i B_{\rho_i}(q_i)} \frac{\partial \tilde{\varphi}}{\partial s} \xi \right| + \sum_i \left| \int_{\partial B_{\rho_i}(q_i)} \tilde{\varphi} \xi \left\langle \frac{\partial}{\partial s}, \nu \right\rangle \right| \\ &\leq C\delta^2 \|\tilde{\varphi}\|_\infty \|\nabla \xi\|_\infty + \|\tilde{\varphi}\|_{W^{1,2}(\mathcal{G})} \|\xi\|_{L^2(\mathcal{B})} + C\delta \|\tilde{\varphi}\|_\infty \|\xi\|_\infty. \end{aligned}$$

Since δ was arbitrarily small,

$$\left| \int_{\mathcal{B}} \tilde{\varphi} \frac{\partial \xi}{\partial s} \right| \leq \|\tilde{\varphi}\|_{W^{1,2}(\mathcal{G})} \|\xi\|_{L^2(\mathcal{B})}.$$

We can do the same for the t -derivative. For $\tilde{\alpha}$ things are even easier, indeed $\tilde{\alpha}$ is Lipschitz. Therefore the average function is $W^{1,2}$ on \mathcal{B} with the same norm as on \mathcal{G} . We can do the same passing from \mathcal{B} to $\mathcal{A} = D_R \setminus \text{Sing}^Q$: again we have to add a (countable) set of points which are isolated in \mathcal{A} , so the same as above applies. Eventually we have proved

Lemma 2.4.3. *On the set $\mathcal{A} = D_R \setminus \text{Sing}^Q$ the average function $\tilde{\Psi} = (\tilde{\varphi}, \tilde{\alpha})$ defines a $W^{1,2}$ map from \mathcal{A} into $\mathbb{C} \times \mathbb{R}$ with norm bounded by the mass of C_r .*

The next step will establish the definitive result on the whole of D_R .

The following corollary is basically a restatement of theorem 2.3.3 as a **relative Lipschitz estimate**, in terms of coordinates in which the current is seen as a multi-valued graph:

Corollary 2.4.1. *Let $x_0 \in \text{Sing}^Q$ and $T_{x_0}C = Q[[D_0]]$, as before. Take coordinates $D^2 \times \mathbb{C} \times \mathbb{R}$ so that x_0 is at the origin and D_0 is identified with $D^2 \times \{0\}$.*

Then $\forall \varepsilon > 0 \exists r = r(\varepsilon, x_0)$ such that

$\forall x = (z, \zeta, a) \in \mathcal{C}^Q := \{p \in \mathcal{C} : \theta(p) = Q\}$ and $x' = (z', \zeta', a') \in \text{spt}C \cap B_r(x_0)$

we have the estimate $|(\zeta, a) - (\zeta', a')|_{\mathbb{C} \times \mathbb{R}} \leq \varepsilon |z - z'|_{\mathbb{R}^2}$.

proof of corollary 2.4.1. The estimate for the third coordinate a is obvious. We need to show that, identifying $\mathbb{C} \equiv \mathbb{R}^2$,

$$|(\zeta - \zeta')|_{\mathbb{R}^2} \leq \varepsilon |z - z'|_{\mathbb{R}^2}.$$

We are going to use theorem 2.3.3, which guarantees the continuity at 0 of tangent cones at points in \mathcal{C}^Q . Choose r s.t. $\forall x \in B_{2r}(0)$ having multiplicity Q the angular distance $\widehat{D_0, T_x C}$ is less than $\frac{\varepsilon}{2}$; we can also guarantee that

$$k(C \llcorner B_{2r}(0), \Sigma_w^X) = Q \quad (2.27)$$

for any $w \in D_0 \cap B_{3r/4}(0)$ and $Y \in \mathbb{C}\mathbb{P}^1$ realizing $\widehat{D_0, Y} \geq \varepsilon$. Assume by contradiction that we can find $x \in \mathcal{C}^Q$ and $y \in \text{spt}C$, with $x, y \in B_r(0)$ for which

$$|(\zeta - \zeta')|_{\mathbb{R}^2} > \varepsilon |z - z'|_{\mathbb{R}^2}$$

holds. Then take $\Sigma_{x,y}$: this 3-surface is transversal to the current at x since $\widehat{T_x C, \Sigma_{x,y}} > \frac{\varepsilon}{2}$ and we can tilt it a bit finding a Σ_x^Y transversal to C , with $\widehat{T_x C, Y} > \frac{\varepsilon}{2}$ and with a non-zero intersection, as already done in the proof of theorem 2.3.3. Then

$$k(C \llcorner B_{2r}(0), \Sigma_x^Y) = k(C \llcorner B_\rho(x), \Sigma_x^Y) + k(C \llcorner (B_{2r}(0) - B_\rho(x)), \Sigma_x^Y) \geq Q + 1,$$

for some small enough $\rho \ll \text{dist}(x, y)$. Since $\widehat{D_0, Y} > \varepsilon$, we can homotope Σ_x^Y into a Σ_w^Y for some $w \in D_0 \cap B_{3r/4}(0)$ keeping it away from C on ∂B_{2r} , so we are contradicting the identity in (2.27). \square

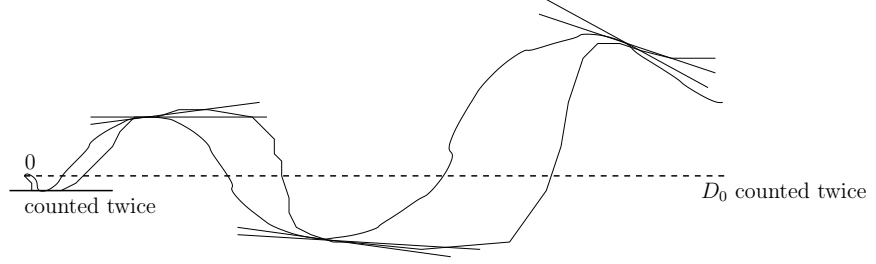

Figure 2.6: An example for $Q = 2$, with the current sketched as two curves. The tangents at points of multiplicity 2 flatten as they approach 0.

Theorem 2.4.2. *The average function $\tilde{\Psi} : D_R \rightarrow \mathbb{R}^3$ is in $W^{1,2}(D_R)$.*

proof of theorem 2.4.2. $Sing^Q$ is a closed set (possibly with positive \mathcal{H}^2 -measure) and on $\mathcal{F} = \pi(Sing^Q)$ (still a closed set) $\tilde{\Psi}$ coincides with the Q branches $\{\Psi_i\}_{i=1}^Q$. We know that the Lipschitz estimate of corollary 2.4.1 holds for any couple of points x, y such that $\tilde{\Psi}(x) \in Sing^Q$. In particular, $\tilde{\Psi}|_{\mathcal{F}}$ is Lipschitz, it is therefore possible to extend it to a function u defined on the whole of D_R which is Lipschitz with constant K equal 3 times the Lipschitz constant of $\tilde{\Psi}|_{\mathcal{F}}$ (see [25] sec. 2.10.44). Let δ be positive and arbitrarily small. Take now a smooth compactly supported function σ_δ such that

$$\sigma_\delta(x) = \begin{cases} 1 & \text{if } dist(x, \mathcal{F}) \leq \delta \\ 0 & \text{if } dist(x, \mathcal{F}) \geq 2\delta \end{cases}$$

and $|D\sigma_\delta| \leq \frac{k}{\delta}$ for some $k > 0$. Explicitly σ_δ can be defined as follows: take a smooth bump-function χ on $[0, \infty)$, which is 1 on $[0, 1)$ and 0 on $[2, \infty)$. Set $\chi_{r,y}(x) = \chi\left(\frac{|x-y|}{r}\right)$ for $x, y \in \mathbb{C}$. Define

$$\sigma_\delta(z) = \frac{G}{\delta^4} \int_{\{x: dist(x, \mathcal{F}) \leq \frac{3\delta}{2}\}} \chi_{\frac{\delta}{4}, z}(w) dw d\bar{w},$$

the right normalization constant G depending on $\int_0^\infty \chi(t)t^3 dt$. Introduce

$$\tilde{\Psi}_\delta := \sigma_\delta u + (1 - \sigma_\delta)\tilde{\Psi}$$

and notice that, for any $\delta > 0$, this function is $W^{1,2}$. Moreover, for $x \in \{dist(x, \mathcal{F}) \leq 2\delta\}$, denoting by $p \in \mathcal{F}$ the point realizing this distance, from corollary 2.4.1 and by the definition of u

$$|(u - \tilde{\Psi})(x)| = |u(x) - u(p) + \tilde{\Psi}(p) - \tilde{\Psi}(x)| \leq 2K|p - x| \leq 4K\delta.$$

In the lines that follow, D denotes the partial derivative with respect to either of the coordinates s, t ; notice that, in order to control $D\tilde{\Psi}_\delta$, we need to take

$D\tilde{\Psi}$ only on the set $\{dist(x, \mathcal{F}) \geq \delta\} \subsetneq \mathcal{A}$, since elsewhere $1 - \sigma_\delta = 0$, so we can freely take derivatives.

$$\begin{aligned} D\tilde{\Psi}_\delta &= (D\sigma_\delta)u + \sigma_\delta Du - (D\sigma_\delta)\tilde{\Psi} + (1 - \sigma_\delta)D\tilde{\Psi} = \\ &= (D\sigma_\delta)(u - \tilde{\Psi}) + \sigma_\delta Du + (1 - \sigma_\delta)D\tilde{\Psi}. \end{aligned}$$

We can now compute

$$\begin{aligned} \|D\tilde{\Psi}_\delta\|_{L^2(D_R)}^2 &\leq \int_{\{\delta \leq dist(x, \mathcal{F}) \leq 2\delta\}} |D\sigma_\delta|^2 |u - \tilde{\Psi}|^2 + \int_{D_R} |\sigma_\delta|^2 |Du|^2 + \\ &+ \int_{\{dist(x, \mathcal{F}) \geq \delta\}} |1 - \sigma_\delta|^2 |D\tilde{\Psi}|^2 \leq c(K, k) + \|D\tilde{\Psi}\|_{L^2(A)}^2 \leq c(K, k). \end{aligned}$$

So the $W^{1,2}$ -norm of the $\tilde{\Psi}_\delta$ are uniformly bounded as $\delta \rightarrow 0$, therefore, by compactness, we can find a sequence $\tilde{\Psi}_{\delta_n}$, $\delta_n \rightarrow 0$, which converges in L^2 and weakly* in $W^{1,2}$ to some $\psi \in W^{1,2}(D_R)$. On the other hand, from the computation above,

$$|\tilde{\Psi}_\delta - \tilde{\Psi}| = |\sigma_\delta(u - \tilde{\Psi})| = \begin{cases} 0 & \text{on } \mathcal{F} \\ \leq 4K\delta & \text{on } \{dist(x, \mathcal{F}) \leq 2\delta\} - \mathcal{F} \\ 0 & \text{on } \{dist(x, \mathcal{F}) \geq 2\delta\} \end{cases},$$

so $\tilde{\Psi}_{\delta_n}$ converge uniformly to $\tilde{\Psi}$ on D_R . Therefore \mathcal{H}^2 -a.e. it holds $\psi = \tilde{\Psi}$ and theorem 2.4.2 is proven. \square

2.4.5 End of the proof of \sharp_1 : unique continuation

In this section we will complete the proof of \sharp_1 , the first part of the inductive step, i.e. the fact that there is no possibility of accumulation among singularities of equal multiplicity.

Hölder estimate. We are going to establish the following

Theorem 2.4.3. (Hölder estimate) *For any small enough disk D_R , there exist constants $C, \delta > 0$ such that, for any $r \leq R$,*

$$\sum_{j=1}^Q \int_{D_r} |\nabla \varphi_j|^2 \leq Cr^\delta. \quad (2.28)$$

This easily yields

$$\int_{D_r} |\nabla \tilde{\Psi}|^2 \leq Cr^\delta. \quad (2.29)$$

Remark 2.4.4. This decay implies that $\tilde{\Psi}$ is $\frac{\delta}{2}$ -Hölder thanks to Morrey's embedding theorem, see [44] for instance.

Remark 2.4.5. The integral in (2.28) should always be understood as

$$\sum_{j=1}^Q \left(\int_{(D_r - \mathcal{F}) \setminus \pi(\text{Sing}^{\leq Q-1})} |d\varphi_j|^2 ds dt + \int_{\mathcal{F}} |\nabla \tilde{\varphi}|^2 \nabla \mathcal{H}^2 \right),$$

where $\mathcal{F} = \pi(\text{Sing}^Q)$; recall that all branches agree with the average on \mathcal{F} and that $\text{Sing}^{\leq Q-1}$ is made of at most countably many points, isolated in $D_r - \mathcal{F}$.

proof of theorem 2.4.3. Remark that the α_j -s are Lipschitz thanks to (2.20); therefore, once (2.28) will be established, (2.29) will follow immediately.

We are going to analyse the behaviour of the function

$$y(r) = \sum_{j=1}^Q \int_{D_r} |\nabla \varphi_j|^2.$$

Remark that, with our choice of ∂ and $\bar{\partial}$, it holds $|\nabla \varphi_j|^2 = |\partial \varphi_j|^2 + |\bar{\partial} \varphi_j|^2$. We already showed in the previous section that, for any r small enough, $y(r)$ is finite, being bounded by the mass of the current in the cylinder $Z_r = D_r \times \mathbb{R}^3 = \{|z| \leq r\}$. Recalling that C is boundaryless,

$$(C \llcorner Z_r)(d\zeta \wedge d\bar{\zeta}) = (\partial(C \llcorner Z_r)) \left(\frac{\zeta d\bar{\zeta} - \bar{\zeta} d\zeta}{2} \right) = i \langle C, |z|, r \rangle (\mathcal{I}m(\zeta d\bar{\zeta})).$$

Denote by T the simple 2-vector describing the oriented approximate tangent plane to the rectifiable set \mathcal{C} ; by definition

$$\begin{aligned} (C \llcorner Z_r) \left(\frac{i}{2} d\zeta \wedge d\bar{\zeta} \right) &= \sum_{j=1}^Q \int_{\{\varphi_j, \alpha_j\}(D_r)} \frac{i}{2} \langle d\zeta \wedge d\bar{\zeta}, T \rangle d\mathcal{H}^2 = \\ &= \sum_{j=1}^Q \int_{D_r - \mathcal{F}} (|\partial \varphi_j|^2 - |\bar{\partial} \varphi_j|^2) ds dt + \sum_{j=1}^Q \int_{\text{Sing}^Q} \frac{i}{2} \langle d\zeta \wedge d\bar{\zeta}, T \rangle d\mathcal{H}^2 = \\ &= \sum_{j=1}^Q \int_{D_r - \mathcal{F}} (|\nabla \varphi_j|^2 - 2|\bar{\partial} \varphi_j|^2) ds dt + \sum_{j=1}^Q \int_{\text{Sing}^Q} \frac{i}{2} \langle d\zeta \wedge d\bar{\zeta}, T \rangle d\mathcal{H}^2. \end{aligned}$$

Recalling that the average $\tilde{\varphi}$ is $W^{1,2}$ and that the tangent plane at points in Sing^Q is Q times the tangent to the average, we can rewrite this last term as

$$\sum_{j=1}^Q \int_{D_r - \mathcal{F}} (|\nabla \varphi_j|^2 - 2|\bar{\partial} \varphi_j|^2) ds dt + Q \int_{\mathcal{F}} (|\nabla \tilde{\varphi}|^2 - 2|\bar{\partial} \tilde{\varphi}|^2) d\mathcal{H}^2.$$

So we have

$$\begin{aligned} & \sum_{j=1}^Q \int_{D_r - \mathcal{F}} |\nabla \varphi_j|^2 ds dt + Q \int_{\mathcal{F}} |\nabla \tilde{\varphi}|^2 d\mathcal{H}^2 = \\ & = \sum_{j=1}^Q \int_{D_r - \mathcal{F}} 2|\bar{\partial} \varphi_j|^2 ds dt + Q \int_{\mathcal{F}} 2|\bar{\partial} \tilde{\varphi}|^2 d\mathcal{H}^2 + \langle C, |z|, r \rangle \left(-\frac{1}{2} \mathcal{I}m(\zeta d\bar{\zeta}) \right). \end{aligned} \quad (2.30)$$

Now (2.23), which is satisfied by the smooth parts of $\{\varphi_j\}_{j=1}^Q$, i.e. on $D_R \setminus \mathcal{F}$ minus countably many points, gives

$$\sum_{j=1}^Q \int_{D_r - \mathcal{F}} |\bar{\partial} \varphi_j|^2 ds dt \leq C_1 \varepsilon^2 \sum_{j=1}^Q \int_{D_r - \mathcal{F}} |\nabla \varphi_j|^2 ds dt + C_2 r^2. \quad (2.31)$$

Putting (2.30) and (2.31) together,

$$\begin{aligned} y(r) &= \sum_{j=1}^Q \left(\int_{D_r - \mathcal{F}} |\nabla \varphi_j|^2 ds dt + \int_{\mathcal{F}} |\nabla \tilde{\varphi}|^2 d\mathcal{H}^2 \right) \leq \\ &\leq 3Q \int_{\mathcal{F}} |\nabla \tilde{\varphi}|^2 d\mathcal{H}^2 + K_1 \langle C, |z|, r \rangle \left(-\frac{1}{2} \mathcal{I}m(\zeta d\bar{\zeta}) \right) + C_3 r^2. \end{aligned}$$

By corollary 2.4.1, $|\nabla \tilde{\varphi}|$ is bounded by a small constant on \mathcal{F} , so

$$y(r) \leq K_1 \langle C, |z|, r \rangle \left(-\frac{1}{2} \mathcal{I}m(\zeta d\bar{\zeta}) \right) + K_2 r^2. \quad (2.32)$$

The slice of the current with $|z| = r$ exists as a rectifiable 1-current for a.e. r , as explained in lemma 1 of [28], page.152. On the set $D_R \setminus \mathcal{F}$, the multi-valued graph is smooth except at a countable set of isolated points. For all but countably many choices of r , ∂D_r will avoid this set. For a.e. r the current $\langle C, |z|, r \rangle$ is described by the same multi-valued graph $\{\varphi_j\}$. This multi-valued graph, being one-dimensional, can be actually described as a superposition of honest $W^{1,2}$ functions as follows:

- (i) $\partial D_r \cap \mathcal{F} = \emptyset$: for such a r , $\{\varphi_j\}$ is smooth on ∂D_r , then, starting from any point in the multigraph, we can follow the loop and we will eventually

come back to the same point after a certain number n of laps, $n_1 \leq Q$. Then we can define the function g_1 to be equal φ_j on an interval I_1 of length $2\pi n_1 r$, and g_1 has the same value at the endpoints of I_1 . Then do the same, starting from a point that was not covered yet by g_1 . This procedure leads to the construction of K smooth functions g_k , $K \leq Q$. By [24], page 164, g_k are $W^{1,2}$ for a.e. r , since it is the restriction of a $W^{1,2}$ function to a line.

- (ii) $\partial D_r \cap \mathcal{F} \neq \emptyset$: in this case the set $\partial D_r - \mathcal{F}$, being open in ∂D_r , must be an at most countable union of open intervals $\cup_i (a_i, b_i)$. Then $\partial D_r \cap \mathcal{F} = \cup_i [b_i, a_{i+1}]$. On each (a_i, b_i) we can give a coherent labelling to the $\{\varphi_j\}$, while on the $[b_i, a_{i+1}]$ all the branches agree. Then we can write the multi-valued graph as a superposition of Q functions g_i . Each g_i is $W^{1,2}$: in fact, on each (a_i, b_i) we can use the result from [24] again, and therefore for a.e. r , $g_i|_{\partial D_r - \mathcal{F}}$ is $W^{1,2}$. Then we can get that $g_i \in W^{1,2}(\partial D_r)$ by the same argument that we used to prove theorem 2.4.2 by means of the Lipschitz property from theorem 2.3.3, which holds on $\partial D_r \cap \mathcal{F}$.

Then, using Hölder's and Poincaré's inequalities, we can write (in the following computation λ_k denotes the average of g_k on I_k and the fourth equality is justified by $\int_{I_k} dg_k = 0$, which comes from the fact that g_k takes the same value at the endpoints of I_k):

$$\begin{aligned}
|\partial(C \lrcorner Z_r)(\zeta d\bar{\zeta})| &= |\langle C, |z|, r \rangle (\zeta \wedge d\bar{\zeta})| = \left| \sum_{j=1}^Q \left(\int_{\partial D_r - \mathcal{F}} \varphi_j d\bar{\varphi}_j + \int_{\partial D_r \cap \mathcal{F}} \tilde{\varphi} d\bar{\tilde{\varphi}} \right) \right| \\
&= \left| \sum_k \int_{I_k} g_k d\bar{g}_k \right| = \left| \sum_k \int_{I_k} (g_k - \lambda_k) d\bar{g}_k \right| \leq \sum_k \left(\int_{I_k} |g_k - \lambda_k|^2 \right)^{\frac{1}{2}} \left(\int_{I_k} |\nabla g_k|^2 \right)^{\frac{1}{2}} \\
&\leq \sum_k K n_k r \left(\int_{I_k} |\nabla g_k|^2 \right) \leq K Q r \sum_{j=1}^Q \left(\int_{\partial D_r - \mathcal{F}} |\nabla \varphi_j|^2 + \int_{\partial D_r \cap \mathcal{F}} |\nabla \tilde{\varphi}|^2 \right).
\end{aligned} \tag{2.33}$$

The function $y(r)$ is weakly increasing in r and absolutely continuous, being an integral; therefore it is a.e. differentiable and, thanks to (2.32) and (2.33), satisfies at a.e. r (we can assume $k > 1$) the inequality

$$y(r) \leq k r y'(r) + c y^2.$$

By setting $v(r) = y(r) - \frac{c}{1-2k} r^2$, we turn the inequality into

$$v(r) \leq k r v'(r).$$

This yields

$$v(\rho) \leq C\rho^{\frac{1}{k}}$$

and then, adding $\frac{c}{1-2k}r^2$, we get the desired estimate for $y(r)$:

$$y(r) \leq Cr^\delta,$$

for some $\delta := \frac{1}{k} > 0$. □

Unique continuation argument: this will conclude the proof of \sharp_1 and is inspired to the techniques used in [58], and before by Aronszajn in [3]. For this section we are going to describe our current by a multi-valued graph $D_R \rightarrow \mathbb{C}^2$, by setting the fourth (real) coordinate equal 0. So we have a multi-valued graph $\{\varphi_j(z), \alpha_j(z)\}_{j=1}^Q$, with α purely real. The average $\tilde{\varphi}(z)$, is a $W^{1,2}$, Hölder (and bounded) function, $\tilde{\alpha}(z)$ is Lipschitz.

Lemma 2.4.4. *There exists a constant K such that, if R is small enough, there exists a $W^{1,2}$ and $C^{1,\delta}$ solution $w(z) : D_R \rightarrow \mathbb{C}$ to the equation*

$$\bar{\partial}w + \nu(\tilde{\varphi}, \tilde{\alpha})\partial w = 0 \tag{2.34}$$

that is a perturbation of the identity, precisely it satisfies

$$|w(z) - z| \leq KR|z|.$$

proof of lemma 2.4.4. For a function u defined on the whole of \mathbb{C} , we seek w of the form $w = \chi_R(1 + u(z))z$, where χ_R is a radial, smooth cut-off function equal to 1 on D_R and 0 on the complement of D_{2R} . The requests on w can be translated as follows

$$\bar{\partial}u + \chi_R \nu(\tilde{\varphi}, \tilde{\alpha})\partial u + \chi_R \frac{\nu(\tilde{\varphi}, \tilde{\alpha})}{z}(1 + u) = 0,$$

$$|u| \leq KR.$$

It is very important at this stage to observe that $\frac{\nu(\tilde{\varphi}, \tilde{\alpha})}{z}$ is an L^∞ function thanks to the Lipschitz estimate of corollary 2.4.1, although it need not be continuous; so there is some constant K (independent of R) such that $\frac{\nu(\tilde{\varphi}, \tilde{\alpha})}{z} \leq K$ (still from corollary 2.4.1 we actually know that this constant goes to 0 as R goes to 0). The solution u will be found by a fixed point method.

Consider the¹⁶ space $H = \{f \in W^{1,2}(\mathbb{C}) \text{ such that } \nabla f \in L^{2,\lambda}\}$, for some $\lambda > 0$ to be chosen later. By a result due to Morrey, these functions are

¹⁶Here we make use of the Morrey space

$$L^{2,\lambda} := \left\{ g : \mathbb{C} \rightarrow \mathbb{R} : \|g\|_{L^{2,\lambda}}^2 := \sup_{x_0 \in \mathbb{C}, \rho > 0} \frac{1}{\rho^\lambda} \int_{B_\rho(x_0)} |g|^2 < \infty \right\}.$$

$\frac{\lambda}{2}$ -Hölder; they also decay at infinity, therefore they are bounded. H is a Banach space with the norm whose square is

$$\begin{aligned} \|f\|_H^2 &= \|f\|_{L^\infty}^2 + \|\nabla f\|_{L^2}^2 + \|\nabla f\|_{L^{2,\lambda}}^2 = \\ &= \sup_{\mathbb{C}} |f|^2 + \int_{\mathbb{C}} |\nabla f|^2 + \sup_{x_0 \in \mathbb{C}, \rho > 0} \frac{1}{\rho^\lambda} \int_{B_\rho(x_0)} |\nabla f|^2. \end{aligned}$$

Define the functional \mathcal{P} on H that sends f to $\mathcal{P}(f)$

$$\mathcal{P}(f)(z) = \frac{1}{2\pi i} \int_{\mathbb{C}} \frac{\chi_R \nu(\tilde{\varphi}, \tilde{\alpha}) \partial f + \chi_R \frac{\nu(\tilde{\varphi}, \tilde{\alpha})}{\xi} (1+f)}{\xi - z} d\xi d\bar{\xi}$$

(all the functions in the integral are functions of ξ). For any fixed z , the integral is finite: this can be seen as follows, by breaking it up as a series of integrals over annuli $A_n(z)$ centered at z with outer and inner radii respectively $\frac{R}{2^n}$ and $\frac{R}{2^{n+2}}$ (all the constants we are calling K are independent of R);

$$\begin{aligned} &\sum_n \frac{2^{n+2}}{R} \int_{A_n(z)} |\chi_R \nu(\tilde{\varphi}, \tilde{\alpha}) \partial f| + \left| \chi_R \frac{\nu(\tilde{\varphi}, \tilde{\alpha})}{\xi} \right| + \left| \chi_R \frac{\nu(\tilde{\varphi}, \tilde{\alpha})}{\xi} f \right| \leq \\ &\leq KR \sum_n \frac{2^n}{R} \left(\int_{A_n(z)} |\chi_R| \right)^{\frac{1}{2}} \left(\int_{A_n(z)} |\partial f|^2 \right)^{\frac{1}{2}} + \sum_n \frac{KR}{2^n} + \sum_n \frac{KR \|f\|_{L^\infty}}{2^n}, \end{aligned} \tag{2.35}$$

where we used $\left\| \frac{\nu(\tilde{\varphi}, \tilde{\alpha})}{z} \right\|_{L^\infty(D_R)} \leq K$; thanks to the finiteness of $\|\nabla f\|_{L^{2,\lambda}}^2$ we can bound the first term in the following way:

$$\begin{aligned} &\sum_n 2^n \left(\int_{A_n(z)} |\chi_R| \right)^{\frac{1}{2}} \left(\int_{A_n(z)} |\partial f|^2 \right)^{\frac{1}{2}} \leq R \sum_n \left(\int_{A_n(z)} |\partial f|^2 \right)^{\frac{1}{2}} = \\ &= R \sum_n \frac{R^{\lambda/2}}{2^{\frac{n\lambda}{2}}} \left(\left(\frac{2^n}{R} \right)^\lambda \int_{A_n(z)} |\partial f|^2 \right)^{\frac{1}{2}} \leq KR \|\nabla f\|_{L^{2,\lambda}}. \end{aligned} \tag{2.36}$$

Note that

$$|\mathcal{P}(0)| \leq KR$$

and from the computations in (2.35) and (2.36) we also see that

$$\|\mathcal{P}(f) - \mathcal{P}(0)\|_{L^\infty} \leq KR \|f\|_H. \tag{2.37}$$

Also observe that, since we only need to integrate on $\xi \in B_{2R}(0)$, for $|z| \geq 4R$ we have $|\xi - z| \geq \frac{|z|}{2}$, so $|\mathcal{P}(f)|$ is bounded by $\frac{KR^2}{|z|}(\|\nabla f\|_{L^2} + \|f\|_{L^\infty})$.

$\mathcal{P}(f)$ is in $W^{1,2}$ (we will shortly show that $\mathcal{P}(f) \in H$) and solves

$$\bar{\partial}(\mathcal{P}(f)) = -\chi_R \nu(\tilde{\varphi}, \tilde{\alpha}) \partial f - \chi_R \frac{\nu(\tilde{\varphi}, \tilde{\alpha})}{z} (1 + f), \quad (2.38)$$

since $\frac{1}{z-\xi}$ is the fundamental solution for the operator $\bar{\partial}$; in fact, $\frac{1}{z-\xi} = \frac{\partial}{\partial z}(\ln|z-\xi|)$, and $\bar{\partial}\partial = i\Delta$, compare [29], page.17.

Therefore, what we are looking for is a fixed point for \mathcal{P} in H . Observe that \mathcal{P} is an affine functional, therefore, to show that it is a contraction in H , it will be enough to show

$$\mathcal{P}(0) \in H,$$

$$\|\mathcal{P}(f) - \mathcal{P}(0)\|_H \leq k\|f\|_H,$$

for any f and for some $0 < k < 1$. From (2.38),

$$\|\bar{\partial}(\mathcal{P}(f) - \mathcal{P}(0))\|_{L^2} \leq KR(\|\nabla f\|_{L^2} + \|f\|_{L^\infty})$$

and, since $\mathcal{P}(f) - \mathcal{P}(0)$ decays at infinity as $\frac{1}{|z|}$, we can integrate by parts to get

$$\|\nabla(\mathcal{P}(f) - \mathcal{P}(0))\|_{L^2} = K\|\bar{\partial}(\mathcal{P}(f) - \mathcal{P}(0))\|_{L^2} \leq KR(\|\nabla f\|_{L^2} + \|f\|_{L^\infty}). \quad (2.39)$$

The fact that

$$\|D(\mathcal{P}(f) - \mathcal{P}(0))\|_{L^{2,\lambda}} \leq KR(\|Df\|_{L^2} + \|f\|_{L^{2,\lambda}})$$

follows from equation (2.38) by theorem 5.4.1. in [44], page. 146.

The last estimate, together with (2.37) and (2.39), implies

$$\|\mathcal{P}(f) - \mathcal{P}(0)\|_H \leq KR\|f\|_H.$$

Similarly we can show that $\mathcal{P}(0) \in H$, with $\|\mathcal{P}(0)\|_H \leq KR$. If R is small enough (recall that $\frac{K}{z} \leq K$ independently of R), we have a contraction and by Caccioppoli's fixed point theorem we have the existence of a unique fixed point u for \mathcal{P} and

$$\|u\|_{L^\infty} \leq 2KR.$$

So we have a Hölder function $w = z(1 + u)$ solution to (2.34). Since $\nu(\tilde{\varphi}, \tilde{\alpha})$ is Hölder-continuous of exponent δ thanks to theorem 2.4.3, by means of a Schauder-type estimate w is $C^{1,\delta}$. \square

Remark 2.4.6. Observe that $|w(z) - z| \leq KR|z|$ implies that at 0, $\partial w \approx 1$, $\bar{\partial} w \approx 0$, with perturbations of order KR . By taking R smaller if necessary, we can assume, since w is $C^{1,\delta}$, that ∂w and $\bar{\partial} w$ stay as close as we like to 1 and 0 in B_R .

Core of the proof of theorem 2.4.1. We are now ready to complete the proof of non-accumulation, which will go on until the end of this section. Take the function $G : \mathbb{C}^3 \rightarrow \mathbb{C}^3$ given by

$$G(z, \zeta, a) = (z, \zeta - \tilde{\varphi}(z), a - \tilde{\alpha}(z)),$$

and consider the pushforward $\Gamma := G_*C$. The map G is proper (if K is compact, $G^{-1}(K)$ is closed by continuity and bounded since the average function is L^∞) and $W^{1,2}$: this gives that the pushforward is well-defined and commutes with the boundary operator. The point here is that the $W^{1,2}$ function G , from a domain in \mathbb{R}^2 into \mathbb{R}^3 , can be approximated by C^1 functions G_ε as $\varepsilon \rightarrow 0$ so that the minors DG_ε converge weakly in L^1 to the minors of DG (see [28], pages 232-233 Propositions 2 and 3). This implies that $\partial\Gamma = 0$ and that the current Γ is described by the multi-valued graph

$$\{\sigma_j, \tau_j\} = \{\varphi_j - \tilde{\varphi}, \alpha_j - \tilde{\alpha}\}. \quad (2.40)$$

From (2.23), the smooth parts of $\{\sigma_j\}$ solve

$$\bar{\partial}\sigma_j + \nu(\tilde{\varphi}, \tilde{\alpha})\partial\sigma_j + \sum_{k=1}^Q S_j^k \sigma_k + \sum_{k=1}^Q T_j^k \tau_k = 0, \quad (2.41)$$

with $|T_j^k|, |S_j^k| \leq K(1 + \sum_{i=1}^Q |\nabla\varphi_i| + \sum_{i=1}^Q |\nabla\alpha_i|)$. Therefore, by the Hölder estimate in theorem 2.4.3, $|T_j^k|, |S_j^k|$ are in $L^2(D_R)$. As for $\{\tau_j\}$, from (2.18) and (2.19) we have that

$$\nabla\alpha_j(z) = h(z, \varphi_j(z), \alpha_j(z)),$$

for a smooth \mathbb{R}^2 -valued h , so

$$\bar{\partial}\tau_j = \sum_{k=1}^Q A_j^k \sigma_k + \sum_{k=1}^Q B_j^k \tau_k,$$

with A_j^k, B_j^k bounded; for $\partial\tau_j$ we have a similar equation, since the τ_j are real (so the equation we wrote actually contains the whole information on the

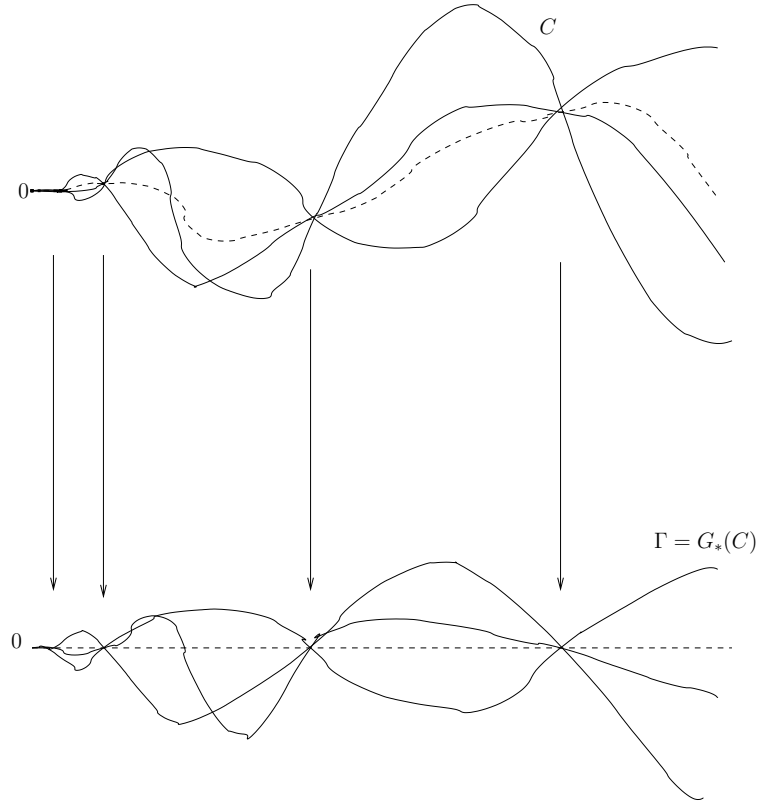

Figure 2.7: A sketch for a 3-valued graph. The average is the dotted line in the first picture. By subtracting it, we get a new 3-valued graph: the points of multiplicity 3 are turned into zeros. The new 3-valued graph still represents a boundaryless current, thanks to the $W^{1,2}$ -estimate on the average.

two real derivatives). Putting them together (we keep writing A, B although these coefficient are different)

$$\bar{\partial}\tau_j + \nu(\tilde{\varphi}, \tilde{\alpha})\partial\tau_j + \sum_{k=1}^Q A_j^k \sigma_k + \sum_{k=1}^Q B_j^k \tau_k = 0, \quad (2.42)$$

with A_j^k, B_j^k bounded.

Observe that singularities of order Q in C have the property that all the branches coincide at those points, therefore they are zeros of the multi-valued graph $\{\sigma_j, \tau_j\}$.

Assume by contradiction the existence of a sequence of singular points in $Sing^Q$ accumulating onto 0.

Then we can take N points $q_n \in \mathcal{F} = \pi(Sing^Q)$ which lie in D_r , with N as large as we want and $r < R$ arbitrarily small and $\{\sigma_j, \tau_j\}(q_n) = 0$, for

$n = 1, \dots, N$. In the estimates to come, one should always pay attention to the fact that the constants obtained must not depend on the chosen N and r , unless otherwise specified.

Define the function

$$g(z) := \prod_{i=1}^N (w(z) - w(q_i)),$$

with the w obtained in the previous lemma. Then g is a C^1 , $W^{1,2}$ function and it solves on D_R

$$\bar{\partial}g + \nu(\tilde{\varphi}, \tilde{\alpha})\partial g = 0.$$

Take $F : \mathbb{C}^3 \rightarrow \mathbb{C}^3$

$$F(z, \zeta, a) = \left(z, \chi_r(z) \frac{\zeta}{g(z)}, \chi_r(z) \frac{a}{g(z)} \right), \quad (2.43)$$

where χ_r is a radial, smooth cut-off, 1 on B_r , 0 on the complement of B_{2r} , with gradient bounded by $\frac{K}{r}$; we are going to analyse the pushforward $F_*(G_*(C))$. First observe that, on any set of the form $D_R \setminus \cup_{i=1}^N B_\delta(q_i)$ for δ as small as we want, F is a C^1 , Lipschitz and proper function. Set

$$A_\delta := (D_R \setminus \cup_{i=1}^N B_\delta(q_i)) \times \mathbb{C} \times \mathbb{C};$$

we can restrict Γ to A_δ , writing $\Gamma_\delta := \Gamma \llcorner A_\delta$, and then the pushforward $\Delta_\delta := F_*(\Gamma_\delta)$ is a well defined i.m. rectifiable current with finite mass, and it can develop boundary only on $(\cup_{i=1}^N \partial B_\delta(q_i)) \times \mathbb{C} \times \mathbb{C}$. Now we will prove

Lemma 2.4.5. *Sending $\delta \rightarrow 0$, we can define the pushforward $\Delta := F_*(\Gamma) = F_*(G_*(C))$ on the whole of $D_R \times \mathbb{C} \times \mathbb{C}$, and Δ is a boundaryless current of finite mass. Then we can rewrite the following relation*

$$\Delta(d\zeta d\bar{\zeta}) = \partial\Delta(\zeta d\bar{\zeta})$$

as a standard integration by parts formula, where both integrals are finite:

$$\int_{B_{2r}(0)} \sum_j \left| \bar{\partial} \left(\frac{\chi_r \sigma_j}{g} \right) \right|^2 = \int_{B_{2r}(0)} \sum_j \left| \partial \left(\frac{\chi_r \sigma_j}{g} \right) \right|^2. \quad (2.44)$$

Remark 2.4.7. Formula (2.44) is the only thing we will need in the sequel. The finiteness of the integrals was not clear in the analogous formula used in [58].

Remark 2.4.8. In this formula $\nabla \left(\frac{\chi_r \sigma_j}{g} \right)$ is understood to be 0 on the set $\mathcal{F} = \pi(\text{Sing}^Q)$. The reason for this will be clear during the proof. On the complement $D_R \setminus \pi(\text{Sing}^Q)$ the gradient is well-defined since the functions are smooth except at the isolated points $\pi(\text{Sing}^{\leq Q-1})$.

proof of lemma 2.4.5. From what we said before, Δ can develop boundary only on $(\cup_{i=1}^N q_i) \times \mathbb{C} \times \mathbb{C}$. Moreover, Δ is described by the multi-valued graph

$$\left\{ \frac{\chi_r \sigma_j}{g}, \frac{\chi_r \tau_j}{g} \right\}_{j=1}^Q. \quad (2.45)$$

From theorem 2.3.3, this multi-valued graph is bounded on D_R , indeed we only have to check it at the points q_i : on some neighbourhood of a chosen q_k , thanks to corollary 2.4.1,

$$|\sigma_j(z)| = |\sigma_j(z) - \sigma(q_k)| \leq K|z - q_k|.$$

By Lagrange's theorem, if the mentioned neighbourhood was chosen small enough (its size should be much smaller than the distances between the q_i 's), then $g(z) \approx \prod_{i=1}^N (z - q_i)$; more precisely, $K_1 \prod_{i=1}^N |z - q_i| \leq |g(z)| \leq K_2 \prod_{i=1}^N |z - q_i|$ with K_1, K_2 close to 1 (the perturbation is due to the perturbations $\partial w \approx 1$ and $\bar{\partial} w \approx 0$). Therefore

$$|\sigma_j(z)| \leq K_{\{q_i\}} |g(z)|,$$

where $K_{\{q_i\}}$ is a constant that depends on the choices of r and the set $\{q_i\}$ (more precisely the constant is of order $\prod_{i \neq j} |q_i - q_j|^{-1}$). This will not be problematic, all that matters to us is the fact that

$$\left\{ \frac{\chi_r \sigma_j}{g}, \frac{\chi_r \tau_j}{g} \right\}_{j=1}^Q$$

is bounded. We further observe that, thanks to the equation solved by g , the multi-valued graph

$$\left\{ \frac{\sigma_j}{g}, \frac{\tau_j}{g} \right\}_{j=1}^Q$$

satisfies, on $D_R \setminus \mathcal{F}$,

$$\bar{\partial} \left(\frac{\sigma_j}{g} \right) + \nu(\tilde{\varphi}, \tilde{\alpha}) \partial \left(\frac{\sigma_j}{g} \right) + \sum_{k=1}^Q S_j^k \left(\frac{\sigma_k}{g} \right) + \sum_{k=1}^Q T_j^k \left(\frac{\tau_k}{g} \right) = 0, \quad (2.46)$$

$$\bar{\partial} \left(\frac{\tau_j}{g} \right) + \nu(\tilde{\varphi}, \tilde{\alpha}) \partial \left(\frac{\tau_j}{g} \right) + \sum_{k=1}^Q A_j^k \left(\frac{\sigma_k}{g} \right) + \sum_{k=1}^Q B_j^k \left(\frac{\tau_k}{g} \right) = 0, \quad (2.47)$$

with the coefficients A, B, S, T as above.

Step 1: Δ has finite mass. Remark that the closed set $\mathcal{F} = \pi(\text{Sing}^Q)$ is included in $\{z : \forall i \sigma_i(z) = \tau_i(z) = 0\}$. The integer multiplicity rectifiable current Δ_δ possesses a.e. on $\mathcal{F} \setminus \cup_{i=1}^N B_\delta(q_i)$ an approximate tangent plane that must be horizontal, i.e. it must be the plane $(z, 0, 0)$. Indeed, this is true at any point of density 1 of the set $\{z : \forall i \sigma_i(z) = \tau_i(z) = 0\} \setminus \cup_{i=1}^N B_\delta(q_i)$, as can be seen from the definition of tangent plane (see [28] page 92).

Let us observe the action of Δ_δ on $d\zeta \wedge d\bar{\zeta}$. By the observation we just made, this action gives 0 on \mathcal{F} , therefore we can extend $\nabla\left(\frac{\chi_r \sigma_j}{g}\right)$ to be 0 on $\mathcal{F} \setminus \cup_{i=1}^N B_\delta(q_i)$ (compare remark 2.4.8). With this understood we can write:

$$\begin{aligned} \Delta_\delta(d\zeta \wedge d\bar{\zeta}) &= \int_{B_{2r} \setminus \cup_{i=1}^N B_\delta(q_i)} \sum_j d\left(\frac{\chi_r \sigma_j}{g}\right) \wedge d\overline{\left(\frac{\chi_r \sigma_j}{g}\right)} = \\ &= \int_{B_{2r} \setminus \cup_{i=1}^N B_\delta(q_i)} \sum_j \left| \bar{\partial}\left(\frac{\chi_r \sigma_j}{g}\right) \right|^2 - \left| \partial\left(\frac{\chi_r \sigma_j}{g}\right) \right|^2. \end{aligned} \quad (2.48)$$

By (2.46) and the triangle inequality $|a-b|^2 \geq \frac{|b|^2}{2} - |a|^2$ we get, recalling that $|\nu| \leq \varepsilon$, (the integrals in the following lines are performed on an arbitrary measurable set disjoint from $\cup_{i=1}^N B_\delta(q_i)$):

$$\begin{aligned} \int \sum_j \left| \sum_{k=1}^Q S_j^k \left(\frac{\sigma_k}{g}\right) + \sum_{k=1}^Q T_j^k \left(\frac{\tau_k}{g}\right) \right|^2 &= \int \sum_j \left| \bar{\partial}\left(\frac{\sigma_j}{g}\right) + \nu(\tilde{\varphi}, \tilde{\alpha}) \partial\left(\frac{\sigma_j}{g}\right) \right|^2 \geq \\ &\geq \int \sum_j \left(\frac{\left| \bar{\partial}\left(\frac{\sigma_j}{g}\right) \right|^2}{2} - \varepsilon^2 \left| \partial\left(\frac{\sigma_j}{g}\right) \right|^2 \right) = \\ &= \int \sum_j \left(\frac{1}{2} + \varepsilon^2 \right) \left| \bar{\partial}\left(\frac{\sigma_j}{g}\right) \right|^2 + \varepsilon^2 \sum_j \left(\left| \bar{\partial}\left(\frac{\chi_r \sigma_j}{g}\right) \right|^2 - \left| \partial\left(\frac{\chi_r \sigma_j}{g}\right) \right|^2 \right) = \\ &= \int \sum_j \left(\frac{1}{2} + \varepsilon^2 \right) \left| \bar{\partial}\left(\frac{\sigma_j}{g}\right) \right|^2 + \varepsilon^2 \Delta_\delta(d\zeta \wedge d\bar{\zeta}) = \\ &= \int \sum_j \left(\frac{1}{2} + \varepsilon^2 \right) \left| \bar{\partial}\left(\frac{\sigma_j}{g}\right) \right|^2 + \varepsilon^2 \partial \Delta_\delta(\zeta \wedge d\bar{\zeta}). \end{aligned} \quad (2.49)$$

Notice that the first term at the beginning of the last chain of inequalities is finite, from the condition on the T 's and S 's, and the fact that $\frac{\sigma_k}{g}, \frac{\tau_k}{g}$ is bounded.

Let us restrict to a small ball $B_\lambda(q_i)$: we will show that

$$\lim_{\rho \rightarrow 0} \int_{B_\lambda(q_i) \setminus B_\rho(q_i)} \sum_j \left| \bar{\partial} \left(\frac{\sigma_j}{g} \right) \right|^2$$

is finite; the global finiteness on D_R will follow since the q_i 's are finite and there are no poles elsewhere. In a first moment we are going to construct a sequence $\rho_n \downarrow 0$ for which $M(\partial\Delta_{\rho_n})$ is equibounded. Since $\Delta_\rho = F_*(\Gamma_\rho)$ and $\|\nabla F\|_{L^\infty(B_\lambda(q_i) \setminus B_\rho(q_i))} \leq \frac{K}{\rho}$, from [28], page 134, we get

$$M(\partial\Delta_\rho) \leq \frac{K}{\rho} M(\partial\Gamma_\rho). \quad (2.50)$$

Moreover, from slicing theory, see Prop. 2 in [28], page 154,

$$\frac{1}{(\lambda/n)^2} \int_0^{\frac{\lambda}{n}} M(\partial\Gamma_\rho) d\rho = \frac{1}{(\lambda/n)^2} \int_0^{\frac{\lambda}{n}} M(\langle \Gamma, |z|, \rho \rangle) \leq \frac{1}{(\lambda/n)^2} M(\Gamma \llcorner (B_{\frac{\lambda}{n}}(q_i) \times \mathbb{C}^2))$$

and this is bounded as $n \rightarrow \infty$ by the monotonicity formula, since the tangent is horizontal at $(q_i, 0, 0)$ and the multiplicity of this point is Q . Then

$$\frac{1}{(\lambda/n)} \int_0^{\frac{\lambda}{n}} M(\partial\Gamma_\rho) d\rho \leq K \frac{\lambda}{n},$$

so by the mean-value theorem there is $\frac{\lambda}{4n} \leq \rho_n \leq \frac{\lambda}{n}$ such that

$$M(\partial\Gamma_{\rho_n}) \leq 2 \frac{1}{(\lambda/n)} \int_0^{\frac{\lambda}{n}} M(\partial\Gamma_\rho) d\rho \leq 2K \frac{\lambda}{n} \leq 8K\rho_n.$$

Now (2.50) yields that $M(\partial\Delta_{\rho_n})$ are equibounded.

As observed above, $\frac{\sigma_j}{g}$ is L^∞ , therefore the function ζ is bounded on Δ , so there is some constant which bounds uniformly in n

$$|\partial\Delta_{\rho_n}(\zeta d\bar{\zeta})|.$$

This yields, together with the inequality (2.49) used with $\delta = \rho_n$ on the set $B_\lambda(q_i) \setminus B_{\rho_n}(q_i)$,

$$\lim_{\rho_n \rightarrow 0} \int_{B_\lambda(q_i) \setminus B_{\rho_n}(q_i)} \sum_j \left| \bar{\partial} \left(\frac{\sigma_j}{g} \right) \right|^2 < \infty;$$

consequently

$$\lim_{\rho \rightarrow 0} \int_{B_\lambda(q_i) \setminus B_\rho(q_i)} \sum_j \left| \bar{\partial} \left(\frac{\sigma_j}{g} \right) \right|^2 < \infty,$$

since this integral is a monotone function of ρ , so the limit must exist and it is enough to check in on a sequence. Once we have the finiteness of

$$\int_{D_R} \sum_j \left| \bar{\partial} \left(\frac{\sigma_j}{g} \right) \right|^2,$$

using $|\Delta_{\rho_n}(d\zeta \wedge d\bar{\zeta})| = |\partial\Delta_{\rho_n}(\zeta d\bar{\zeta})| < \infty$ again, by (2.48) we also get the finiteness of

$$\int_{D_R} \sum_j \left| \partial \left(\frac{\sigma_j}{g} \right) \right|^2.$$

This implies that the Jacobian minors of $\frac{\sigma_j}{g}$ are in L^1 , so the finiteness of the mass can be obtained by the Area formula¹⁷, see [28] page 225.

Step 2: Δ has no boundary. As said above, we only have to exclude boundary terms localized at the points q_i . As before, we restrict ourselves to $\Delta \llcorner B_\lambda(q_i) \times \mathbb{C}^2$. During this step, we will keep denoting this current by Δ . To simplify things, we will test $\partial\Delta$ only on the 1-forms $\chi_\rho(z)\zeta d\bar{\zeta}$, which is needed for the integration by parts formula (2.44); the proof for other 1-forms is similar¹⁸. Since the possible boundary in the interior of D_R is localized only in $q_i \times \mathbb{C}^2$, the result will be the same for any ρ .

$$\partial\Delta(\chi_\rho(z)\zeta d\bar{\zeta}) = \Delta(d\chi_\rho \wedge \zeta d\bar{\zeta}) + \Delta(\chi_\rho d\zeta \wedge d\bar{\zeta}).$$

From the previous step,

$$|\Delta(\chi_\rho d\zeta \wedge d\bar{\zeta})| \leq \int_{B_{2\rho}(q_i)} \sum_j \left| \nabla \left(\frac{\sigma_j}{g} \right) \right|^2 \rightarrow 0$$

for $\rho \rightarrow 0$. Let us now analyse the first term:

$$\begin{aligned} |\Delta(d\chi_\rho \wedge \zeta d\bar{\zeta})| &= \left| \int_{B_{2\rho}(q_i) \setminus B_\rho(q_i)} \sum_j \partial\chi_\rho \frac{\sigma_j}{g} \bar{\partial} \left(\frac{\sigma_j}{g} \right) \right| \leq \\ &\leq \int_{B_{2\rho}(q_i) \setminus B_\rho(q_i)} \frac{K}{\rho} \left\| \frac{\sigma_j}{g} \right\|_{L^\infty} \left| \nabla \left(\frac{\sigma_j}{g} \right) \right| \end{aligned}$$

¹⁷Recall that it is enough to apply the Area formula to the smooth parts of the current Δ that are above $D_R \setminus \mathcal{F}$. The rest of the current lies in \mathcal{F} , which has finite measure.

¹⁸For the reader who is familiar with the support theorem for Flat-currents (see [28] page 525), we remark that the absence of boundary can be obtained by showing, via an approximation argument, that $\partial\Delta$ is a Flat 1-current. The quoted theorem then implies that $\partial\Delta = 0$.

and by Hölder's inequality

$$\leq \left\| \frac{\sigma_j}{g} \right\|_{L^\infty} \frac{K}{\rho} 2\rho \left(\int_{B_{2\rho}(q_i)} \sum_j \left| \nabla \left(\frac{\sigma_j}{g} \right) \right|^2 \right)^{\frac{1}{2}}.$$

This integral goes to 0 as $\rho \rightarrow 0$ thanks to the previous step. So there is no boundary term at any of the q_i when we test on the one form $\zeta d\bar{\zeta}$. \square

We are now ready to finish the proof of non accumulation started before lemma 2.4.5: recall that we assumed, by contradiction, the existence of N points $q_n \in \mathcal{F} = \pi(\text{Sing}^Q)$ which lie in D_r , with N as large as we want and $r < R$ arbitrarily small and $\{\sigma_j, \tau_j\}(q_n) = 0$, for $n = 1, \dots, N$. From Leibnitz rule and (2.46)

$$\begin{aligned} \int_{B_{2r}} \sum_j \left| \bar{\partial} \left(\frac{\chi_r \sigma_j}{g} \right) \right|^2 &\leq Kr^{-2} \int_{B_{2r} \setminus B_r} \sum_j \left| \frac{\sigma_j}{g} \right|^2 + \int_{B_{2r}} \sum_j |\chi_r|^2 \left| \bar{\partial} \left(\frac{\sigma_j}{g} \right) \right|^2 \\ &= Kr^{-2} \int_{B_{2r} \setminus B_r} \sum_j \left| \frac{\sigma_j}{g} \right|^2 + \int_{B_{2r}} \sum_j |\nu(\tilde{\varphi}, \tilde{\alpha})|^2 |\chi_r|^2 \left| \bar{\partial} \left(\frac{\sigma_j}{g} \right) \right|^2 + \\ &+ K \int_{B_{2r}} \left(1 + \sum_{i=1}^Q |\nabla \varphi_i|^2 + \sum_{i=1}^Q |\nabla \alpha_i|^2 \right) \sum_j \left(\left| \chi_r \frac{\sigma_j}{g} \right|^2 + \left| \chi_r \frac{\tau_j}{g} \right|^2 \right). \end{aligned}$$

Now, using $|\nu| \leq \varepsilon$ and (2.44) (notice that the previous lemma and the fact that $\{\frac{\sigma}{g}, \frac{\tau}{g}\}$ is bounded guarantee the finiteness of all terms),

$$\begin{aligned} \int_{B_{2r}} \sum_j |\nu(\tilde{\varphi}, \tilde{\alpha})|^2 \left| \chi_r \bar{\partial} \left(\frac{\sigma_j}{g} \right) \right|^2 &= \int_{B_{2r}} \sum_j |\nu(\tilde{\varphi}, \tilde{\alpha})|^2 \left| -\partial \chi_r \left(\frac{\sigma_j}{g} \right) + \bar{\partial} \left(\frac{\chi_r \sigma_j}{g} \right) \right|^2 \\ &\leq K\varepsilon^2 r^{-2} \int_{B_{2r} \setminus B_r} \sum_j \left| \frac{\sigma_j}{g} \right|^2 + \varepsilon^2 \int_{B_{2r}} \left| \bar{\partial} \left(\frac{\chi_r \sigma_j}{g} \right) \right|^2. \end{aligned}$$

Putting all together, with a further use of (2.44) on the l.h.s., we get

$$\int_{B_{2r}} \sum_j \left| \nabla \left(\frac{\chi_r \sigma_j}{g} \right) \right|^2 = 2 \int_{B_{2r}} \sum_j \left| \bar{\partial} \left(\frac{\chi_r \sigma_j}{g} \right) \right|^2 \leq Kr^{-2} \int_{B_{2r} \setminus B_r} \sum_j \left| \frac{\sigma_j}{g} \right|^2 + \quad (2.51)$$

$$+K \int_{B_{2r}} \left(1 + \sum_{i=1}^Q |\nabla \varphi_i|^2 + \sum_{i=1}^Q |\nabla \alpha_i|^2 \right) \sum_j \left(\left| \chi_r \frac{\sigma_j}{g} \right|^2 + \left| \chi_r \frac{\tau_j}{g} \right|^2 \right).$$

Similarly, from (2.47), and using the analogous partial integration

$$\int_{B_{2r}(0)} \sum_j \left| \bar{\partial} \left(\frac{\chi_r \tau_j}{g} \right) \right|^2 = \int_{B_{2r}(0)} \sum_j \left| \partial \left(\frac{\chi_r \tau_j}{g} \right) \right|^2,$$

we get

$$\begin{aligned} \int_{B_{2r}} \sum_j \left| \nabla \left(\frac{\chi_r \tau_j}{g} \right) \right|^2 &\leq Kr^{-2} \int_{B_{2r} \setminus B_r} \sum_j \left| \frac{\tau_j}{g} \right|^2 + \\ &+K \int_{B_{2r}} \left(1 + \sum_{i=1}^Q |\nabla \varphi_i|^2 + \sum_{i=1}^Q |\nabla \alpha_i|^2 \right) \sum_j \left(\left| \chi_r \frac{\sigma_j}{g} \right|^2 + \left| \chi_r \frac{\tau_j}{g} \right|^2 \right). \end{aligned} \quad (2.52)$$

Set now $v := \max_j \left\{ \left| \chi_r \frac{\sigma_j}{g} \right|, \left| \chi_r \frac{\tau_j}{g} \right| \right\}$. This function is $W^{1,2}$: indeed, this is true on $D_{2r} \setminus \pi(\text{Sing}^{\leq Q})$, since it is the maximum of $W^{1,2}$ functions; then by arguments already used,

- $\pi(\text{Sing}^{\leq Q-1})$ are isolated points so we can extend the $W^{1,2}$ estimate to $D_{2r} \setminus \pi(\text{Sing}^Q)$;
- then we extend to $D_{2r} \setminus (\cup_{i=1}^N B_\delta(q_i) \cap \mathcal{F})$ for any arbitrarily small δ , thanks to the fact that $v = 0$ on $\text{Sing}^Q \setminus \{q_i\}$;
- finally, sending $\delta \rightarrow 0$, to the whole of D_R since the q_i are isolated.

Also observe that, by the Cauchy-Schwarz inequality, $|\nabla(|v|)| \leq |\nabla v|$, so

$$\int_{B_{2r}} |\nabla v|^2 \leq \int_{B_{2r}} \sum_j \left| \nabla \left(\frac{\chi_r \sigma_j}{g} \right) \right|^2 + \sum_j \left| \nabla \left(\frac{\chi_r \tau_j}{g} \right) \right|^2,$$

so (3.53) and (2.52) imply

$$\begin{aligned} \int_{B_{2r}} |\nabla v|^2 &\leq Kr^{-2} \int_{B_{2r} \setminus B_r} \sum_j \left(\left| \frac{\sigma_j}{g} \right|^2 + \left| \frac{\tau_j}{g} \right|^2 \right) + \\ &+K \int_{B_{2r}} \left(1 + \sum_{i=1}^Q |\nabla \varphi_i|^2 + \sum_{i=1}^Q |\nabla \alpha_i|^2 \right) v^2. \end{aligned}$$

Recall that $\left(1 + \sum_{i=1}^Q |\nabla \varphi_i|^2 + \sum_{i=1}^Q |\nabla \alpha_i|^2\right)$ is L^1 by theorem 2.4.3 (Hölder estimate); then, by lemma 5.4.1. in [44], we get the existence of $\delta > 0$ such that the last term can be bounded by

$$\int_{B_{2r}} \left(1 + \sum_{i=1}^Q |\nabla \varphi_i|^2 + \sum_{i=1}^Q |\nabla \alpha_i|^2\right) v^2 \leq Kr^\delta \int_{B_{2r}} |\nabla v|^2,$$

so we can write

$$r^2 \int_{B_{2r}} |\nabla v|^2 \leq K \int_{B_{2r} \setminus B_r} \sum_j \left(\left| \frac{\sigma_j}{g} \right|^2 + \left| \frac{\tau_j}{g} \right|^2 \right);$$

now, since $v \in W_0^{1,2}(B_{2r})$, by Poincaré's inequality

$$\int_{B_{2r}} v^2 \leq K \int_{B_{2r} \setminus B_r} \sum_j \left(\left| \frac{\sigma_j}{g} \right|^2 + \left| \frac{\tau_j}{g} \right|^2 \right).$$

Since $\sum_j \left(\left| \chi_r \frac{\sigma_j}{g} \right|^2 + \left| \chi_r \frac{\tau_j}{g} \right|^2 \right) \leq 2Qv^2$ by definition of v , and $\chi_r = 1$ on B_r ,

the last inequality implies the following Carleman-type estimate

$$\int_{B_{r/4}} \sum_j \left(\left| \frac{\sigma_j}{g} \right|^2 + \left| \frac{\tau_j}{g} \right|^2 \right) \leq K \int_{B_{2r} \setminus B_r} \sum_j \left(\left| \frac{\sigma_j}{g} \right|^2 + \left| \frac{\tau_j}{g} \right|^2 \right), \quad (2.53)$$

with K independent of r and the cardinality N of the set $\{q_i\}$. Assume that the $\{q_i\}$ were chosen much inside D_r , say in $D_{r/4}$. Then, from the definition of g , if r was chosen small enough (which doesn't influence K), on the l.h.s. of (2.53) $g \leq \left(\frac{3r}{4}\right)^N$, while on the r.h.s. $g \geq \left(\frac{3|z|}{4}\right)^N$, so we get

$$\int_{B_{r/4}} \sum_j |\sigma_j|^2 + |\tau_j|^2 \leq K \int_{B_{2r} \setminus B_r} \left(\frac{r}{|z|} \right)^{2N} \sum_j |\sigma_j|^2 + |\tau_j|^2;$$

letting N go to infinity, we can make the r.h.s. as small as we wish, which implies

$$\int_{B_{r/4}} \sum_j |\sigma_j|^2 + |\tau_j|^2 = 0,$$

i.e. all the branches of the multigraph describing our original current must agree with the average on a neighbourhood of 0. But then this average must be itself a Special Legendrian counted Q times, therefore it must be smooth in this neighbourhood thanks to the basic step of the induction. We have therefore completed the proof of \sharp_1 .

2.5 Proof of \sharp_2 : non-accumulation of lower-order singularities

To complete the proof of the inductive step, we have to exclude the possibility of accumulation of points in $Sing^{\leq Q-1}$ to a singularity of order Q .

Let $x_0 \in Sing^Q$; from theorem 2.4.1 (and recalling the monotonicity formula) we can assume that we work in a ball B^5 centered at x_0 such that all the points of C in this ball are of multiplicity at most Q and

$$B^5 \cap Sing^Q = \{x_0\}.$$

By the inductive assumption, the other singularities in B^5 are isolated and of multiplicity $\leq Q - 1$.

Thus we can take local coordinates about x_0 in such a way that C is given by a Q -valued graph over D^2 that we denote by

$$\{(\varphi_j(z), \alpha_j(z))\}_{j=1 \dots Q} \quad ,$$

where $z = x + iy$ is the coordinate in the Disk D^2 , $\varphi_i \in \mathbb{C}$ and $\alpha_i \in \mathbb{R}$ and where for all $j \in \{1, \dots, Q\}$ it holds $(\varphi_j(0), \alpha_j(0)) = (0, 0)$.

Assumption on the multiplicity. In order to simplify the exposition, we assume that all smooth points of $C \llcorner B^5$ have multiplicity exactly 1. The following argument shows that there is no loss of generality in doing so¹⁹.

If a smooth point p has multiplicity $M \geq 2$, it must have a neighbourhood all made of smooth points of equal multiplicity M . Take the maximal of such neighbourhoods and denote it by \mathcal{U} . This smooth submanifold, counted once, constitutes an i.m. current U in B^5 , whose smooth points have multiplicity 1, possibly having singularities located at the same points where the singular points of C were.

We claim that U is a boundaryless current. Let us prove it. Let $\{q_i\}$ be the at most countable singularities of C of order $\leq Q - 1$, possibly accumulating onto 0. First of all, from the maximality of \mathcal{U} we can deduce that the topological boundary $\partial\mathcal{U}$ inside the smooth 2-dimensional submanifold $(C \setminus \{0\}) \setminus \cup q_i$ is empty. This implies that ∂U must be supported at the singularities. Thanks to this, we can localize U to a neighbourhood V_i^5 of each isolated singularity and we can exclude the presence of boundary at each q_i as follows. By abuse of notation we keep denoting by U the localized current.

¹⁹This assumption is not really needed to perform the proof presented in this last section, however it makes it less technical.

We will write B_λ for the ball $B_\lambda^5(q_i)$. For almost any choice of $\lambda > 0$, the slice of U with ∂B_λ exists as a 1-dimensional rectifiable current of finite mass and it is the same current, with opposite sign, as the boundary of $U_\lambda := U \llcorner (V_i^5 \setminus B_\lambda)$. Moreover from slicing theory we have

$$\int_0^{\bar{\lambda}} M(\partial U_\lambda) d\lambda \leq M(U \llcorner B_{\bar{\lambda}}) \leq M(C \llcorner B_{\bar{\lambda}}).$$

From the monotonicity formula and by the mean value theorem, we get the existence of a sequence $\{\lambda_n\} \rightarrow 0$ of positive real numbers such that

$$M(\partial U_{\lambda_n}) \leq K\lambda_n,$$

which implies that $\partial U_{\lambda_n} \rightarrow 0$. On the other hand, $U_{\lambda_n} \rightarrow U$ since $M(U - U_{\lambda_n}) = M(U \llcorner B_{\lambda_n}) \rightarrow 0$, therefore $\partial U_{\lambda_n} \rightarrow \partial U$ and we get $\partial U = 0$.

Once we have excluded the presence of boundary located at the singularities q_i , we can perform the same argument to exclude boundary located at 0. So U is boundaryless²⁰.

The current $C - (M - 1)U$ is thus still a Special Legendrian cycle and has exactly the same singularities as C ; it is therefore enough to prove the result about non accumulation for this Special Legendrian "subcurrent", in order to get in for C . Starting now from $C - (M - 1)U$, we can inductively repeat the argument and get to the desired assumption of having multiplicity 1 at all smooth points.

We still denote by π the map on C which assigns the coordinate z . With the assumption just discussed, the singularities of order $\leq Q - 1$ are located exactly at the points $\pi^{-1}(z_l)$ for which $z_l \neq 0$ and

$$\exists j \neq k \quad \text{s.t.} \quad (\varphi_j(z_0), \alpha_j(z_0)) = (\varphi_k(z_0), \alpha_k(z_0)) \quad . \quad (2.54)$$

As recalled at the beginning of this section, we are working under the assumption that the points in (2.54) form a discrete set in $D^2 \setminus 0$, therefore at most countable. Away from them, each branch j of the multiple valued graph satisfies a system²¹ of the form

$$\begin{cases} \partial_{\bar{z}} \varphi_j = \nu((\varphi_j, \alpha_j), z) & \partial_z \varphi_j + \mu((\varphi_j, \alpha_j), z) \\ \nabla \alpha_j = h((\varphi_j, \alpha_j), z), \end{cases} \quad (2.55)$$

²⁰An alternative argument to exclude boundary located at the singular set, is to use an analogous approximation U_n of U obtained by "cutting out" smaller and smaller balls around the singular set and show that ∂U_n is a Cauchy sequence in the Flat-norm, therefore obtaining that ∂U is a Flat 1-dimensional current. The support theorem (see [28] page 525) tells us that a non-zero Flat 1-current cannot be supported on a set of 0-Hausdorff dimension, therefore $\partial U = 0$.

²¹These are the equations we derived in (2.21) and (2.23). With respect to the notations in sections 2.4 and 2.4.5, we are changing here the signs of the functions ν and μ .

where ν and μ are smooth complex valued functions on \mathbb{R}^5 such that $\nu(0) = \mu(0) = 0$ and h is a smooth \mathbb{R}^2 -valued map on \mathbb{R}^5 .

To complete the proof of the main result we need to show

Theorem 2.5.1. *With the previous notations, let 0 be a singular point of multiplicity Q of the Special Legendrian cycle. If we are working under the (inductive) assumption that all the other singularities are of order $\leq Q - 1$ and are isolated in $B^5 \setminus \{0\}$, then there is no accumulation at 0 of singularities of the form (2.54).*

The proof of the theorem 2.5.1 we are giving below is inspired by the homological type argument in [58], pages 85-86. The heuristic idea has been given in the introduction: we want to find a function that is able to “detect” the presence of isolated singularities when its topological degree is observed. Global bounds on the degree imply that it is impossible to have a sequence of isolated singularities in $Sing^{\leq Q-1}C$ accumulating onto 0.

In view of this ideas, we are now going to analyse the structure of the Special Legendrian current in a neighbourhood of an isolated singular point q .

The structure of an isolated singularity. Recalling our assumption on multiplicities, given an isolated singular point q in C , for a small enough radius ρ , $C \llcorner B_\rho^5(q)$ can be represented as

$$C \llcorner B_\rho^5(q) = \bigoplus_{k=1}^N L_k, \quad (2.56)$$

where each L_k is either a smooth Special Legendrian embedded disk, or an immersed one branched at q ; N is bounded by the multiplicity of q in C and $L_k \neq L_l$ if $k \neq l$.

We give a brief description of the reason why this is true. Consider the slice $\langle C, |p - q| = \rho \rangle$: this is a smooth, one-dimensional, boundaryless current γ , so it is made of several smooth simple closed curves γ_i , each one counted with multiplicity 1.

Each γ_i can be obtained as the image of a circle $(\rho \cos t, \rho \sin t) \subset \mathbb{R}^2 \cong \mathbb{C}$ through a smooth simple map. By the smoothness assumption on all points of γ_i , we can get a smooth parametrization from an annulus in \mathbb{C} to a subset of C contained in a corresponding annulus. Take the maximal extension: since there are no other singularities, this must be a smooth simple map from $B_\rho \setminus \{0\}$ into $(C \llcorner B_\rho) \setminus \{q\}$.

By a removable singularity theorem, this map can be extended smoothly in 0. There is no real need to invoke such a theorem: the extension to 0 is obviously continuous, and it is indeed smooth by standard elliptic theory.

Thus get a smooth map from B_ρ into $C\mathbb{L}B_\rho$; repeat the same argument for all connected components i 's. A mass comparison shows that this procedure must cover the whole of $C\mathbb{L}B_\rho$.

Remark 2.5.1. For each branched disk L_k in (2.56), we have a smooth parametrization from $D^2 \subset \mathbb{C}$ into \mathbb{R}^5 , with a critical point at 0. Just like in section 2.4, by using (2.1), the calibrating condition for the Special Legendrian yields that the parametrization is a pseudo-holomorphic curve²².

By elliptic theory and conformality, as explained in section 6 of [42], one can change coordinates diffeomorphically and find that, in the new coordinates, the parametrization is of the form $(w^I, f(w))$ for $w \in D^2 \subset \mathbb{C}$, $f : D^2 \rightarrow \mathbb{R}^3$, $I \in \mathbb{N}$, $I \geq 1$, $f(w) = o(|w|^I)$. However, we are not going to make use of this result.

Relative difference of branches around an isolated singularity.

The following discussion is needed to understand the behaviour of the difference functions $\varphi_i - \varphi_j$ and $\alpha_i - \alpha_j$ for $i \neq j$ in a small neighbourhood of an isolated singularity q ; let $z_l = \pi(q)$ and be M the multiplicity of q . Choose a neighbourhood centered at q , having a cylindrical form $B_\rho^2 \times B_\rho^3$, with ρ small enough so that $C\mathbb{L}(B_\rho^2 \times B_\rho^3)$ is described as a M -valued graph above $B_\rho^2(z_l)$, namely

$$\{(\varphi_j(z), \alpha_j(z))\}_{j=1 \dots M}.$$

Remark that $(\varphi_j(z_l), \alpha_j(z_l))$ coincide for all $j = 1, \dots, M$, while for $z \neq z_l$ we have $(\varphi_j(z), \alpha_j(z)) \neq (\varphi_i(z), \alpha_i(z))$ whenever $i \neq j$ (this follows from the assumption on multiplicities taken at the beginning of this section).

Above any $z \in B_\rho^2(z_l) \setminus \{z_l\}$, consider the difference vector $((\varphi_i - \varphi_j)(z), (\alpha_i - \alpha_j)(z)) \in \mathbb{R}^3$ for any choice of $i \neq j$. The tail and head of this vector will belong respectively to some L_k and L_l , possibly with $k = l$. Observe that, moving this vector by continuity for $z \neq z_l$, this condition on head and tail will be preserved with the same k and l ; remark that if $k = l$ the *difference vector* is joining two points of the same branched disk, while if $k \neq l$ it is joining points belonging to different disks. In figure 2.8, picture on the left, there is an attempt to visualize this in the case of a single branched disk (so $k = l$) that gives rise to a 2-valued graph locally around the branch point.

²²The term pseudo-holomorphic curve is commonly used for a map taking values in an almost-complex manifold, so an even-dimensional manifold with an almost complex structure J on the tangent bundle (on each tangent $J^2 = -Id$). So here there is an abuse of terminology, since our parametrization takes values in \mathbb{R}^5 with a J that is defined on the 4-dimensional hyperplanes of the contact distribution. However we can extend J to $\mathbb{R}^5 \times \mathbb{R}$ by setting that the vertical vector of \mathbb{R}^5 (orthogonal to the hyperplanes) is sent into the extra direction added. This gives an almost complex structure on \mathbb{R}^6 , we can look at the parametrization as \mathbb{R}^6 -valued, so that it becomes pseudo-holomorphic.

For any fixed choice of $(k, l) \in \{1, \dots, N\} \times \{1, \dots, N\}$, we are now going to analyse the functions $\varphi_i - \varphi_j$ and $\alpha_i - \alpha_j$ for $i \neq j$ s.t.

$$(\varphi_i, \alpha_i) \text{ belongs to a branch of } L_k \text{ and } (\varphi_j, \alpha_j) \text{ to a branch of } L_l, \quad (2.57)$$

with particular interest to the behaviour of the *difference vector* when it evolves as described above.

This means that, in the discussion that follows, leading to lemmas 2.5.2 and 2.5.3, we need to focus only on the disks L_k and L_l of (2.56).

From the second equation of the Special Legendrian system (2.55), taking differences, we get locally

$$\nabla(\alpha_i - \alpha_j) = F \cdot (\varphi_i - \varphi_j) + G \cdot (\alpha_i - \alpha_j), \quad (2.58)$$

where F, G are bounded functions of $(z, \varphi_i(z), \varphi_j(z), \alpha_i(z), \alpha_j(z))$ depending on the derivatives of h ; so they satisfy $|F|, |G| \leq K_0 < \infty$. Take a positive $\bar{t} < \frac{1}{4K_0}$. In the ball $\{|z - z_l| \leq \bar{t}\}$, consider the point w where $|\alpha_i - \alpha_j|$ realizes its maximum, taken over all possible choices of $i \neq j$ satisfying (2.57). Along the segment I joining z_l to w , we can coherently label $\alpha_i, \alpha_j, \varphi_i$ and φ_j as smooth functions with $\alpha_i(z_l) = \alpha_j(z_l)$ and $\varphi_i(z_l) = \varphi_j(z_l)$. It makes then sense to integrate the equation (2.58) above along the segment I and get

$$(\alpha_i - \alpha_j)(w) = \int_0^t (F|_I)(s)(\varphi_i - \varphi_j)(s)ds + \int_0^t (G|_I)(s)(\alpha_i - \alpha_j)(s)ds$$

for $t = |w| \leq \bar{t}$.

Notational convention: remark that we are using k, l for the fixed choice of disks in (2.56); for the branches of the M -valued graph describing $CL(B_\rho^2 \times B_\rho^3)$ we use, instead, the letters i, j . In the present discussion, we are going to denote by $\|\alpha_i - \alpha_j\|_{L^\infty(B^2(z_l, \bar{t}))}$ the quantity $\sup\{|\alpha_i - \alpha_j|(z) : z \in B^2(z_l, \bar{t}) \text{ and } i \neq j \text{ are as in (2.57)}\}$. An analogous convention holds for $\|\varphi_i - \varphi_j\|_{L^\infty(B^2(z_l, \bar{t}))}$.

Thus taking the L^∞ -norm over all possible choices of $i \neq j$ satisfying (2.57) with the fixed choice of (k, l) , we have

$$\begin{aligned} \|\alpha_i - \alpha_j\|_{L^\infty(B^2(z_l, t))} &= |\alpha_i - \alpha_j|(t) \leq \\ &\leq K_0 t \|\varphi_i - \varphi_j\|_{L^\infty(B^2(z_l, t))} + K_0 t \|\alpha_i - \alpha_j\|_{L^\infty(B^2(z_l, t))}; \end{aligned}$$

this implies

$$\|\alpha_i - \alpha_j\|_{L^\infty(B^2(z_l, \bar{t}))} \leq \frac{1}{2} \|\varphi_i - \varphi_j\|_{L^\infty(B^2(z_l, \bar{t}))},$$

with i and j as prescribed in (2.57). Choosing \bar{t} smaller at the beginning, we can get an arbitrarily small constant instead of $\frac{1}{2}$: therefore

$$\frac{\|\alpha_i - \alpha_j\|_{L^\infty(B^2(z_l, t))}}{\|\varphi_i - \varphi_j\|_{L^\infty(B^2(z_l, t))}} \rightarrow 0 \text{ as } t \rightarrow 0. \quad (2.59)$$

For $i \neq j$ as in (2.57), we introduce the following multivalued graph on $\{|z| \leq 1\}$, with $\rho > 0$:

$$(\Theta_{ij}^\rho(z), \Xi_{ij}^\rho(z)) = \left(\frac{(\varphi_i - \varphi_j)(z_l + \rho z)}{\|\varphi_i - \varphi_j\|_{L^\infty(B^2(z_l, \rho))}}, \frac{(\alpha_i - \alpha_j)(z_l + \rho z)}{\|\varphi_i - \varphi_j\|_{L^\infty(B^2(z_l, \rho))}} \right).$$

Remark 2.5.2. This multi-valued graph has either one or two connected components. The former case happens when $k = l$, the latter when $k \neq l$. In the latter case, however, the two connected components are symmetrical with respect to $(z, 0, 0)$: one of them is just minus the other. Of course, this happens when we take $\varphi_i - \varphi_j$ and then $\varphi_j - \varphi_i$. So we can basically assume to be always dealing with a unique connected component.

We are interested in the behaviour of $(\Theta_{ij}^\rho(z), \Xi_{ij}^\rho(z))$ as $\rho \rightarrow 0$.

Thanks to (2.59), both Θ_{ij}^ρ and Ξ_{ij}^ρ are smaller or equal than 1 in modulus; more precisely Ξ_{ij}^ρ goes uniformly to 0 as $\rho \rightarrow 0$ and $|\Theta_{ij}^\rho|$ always realizes the value 1 by definition. From (2.55) and (2.58), the branches of this multivalued graph solve locally on $\{0 < |z| \leq 1\}$ equations of the following type:

$$\begin{cases} \bar{\partial}\Theta_{ij}^\rho(z) + \nu(z_l + \rho z)\partial\Theta_{ij}^\rho(z) + \rho S(\rho z)\Theta_{ij}^\rho(z) + \rho T(\rho z)\Xi_{ij}^\rho(z) = 0 \\ \nabla\Xi_{ij}^\rho(z) = \rho F(\rho z)\Theta_{ij}^\rho(z) + \rho G(\rho z)\Xi_{ij}^\rho(z), \end{cases} \quad (2.60)$$

with $F, G \in L^\infty$ and $S, T \in L^2$.

We prove now:

Lemma 2.5.1. *As $\rho \rightarrow 0$ the multi-valued graph $(\Theta_{ij}^\rho(z), \Xi_{ij}^\rho(z))$ converges uniformly to a multi-valued graph $(\Theta_{ij}(z), 0)$, where Θ_{ij} is holomorphic in*

the variable $w = \sqrt{\frac{1}{1 + |\nu(z_l)|^2}} z + \nu(z_l)\sqrt{\frac{1}{1 + |\nu(z_l)|^2}} \bar{z}$ and homogeneous, i.e. there is $\tau \in \mathbb{Q}$ such that, for any $\lambda \in (0, \infty)$ it holds $\Theta_{ij}(\lambda z) = \lambda^\tau \Theta_{ij}(z)$.

proof of lemma 2.5.1. All the multivalued graphs of the sequence are pinched at 0. By an argument similar to the one used in theorem 2.4.3, we can deduce a uniform Hölder estimate on $(\Theta_{ij}^\rho(z), \Xi_{ij}^\rho(z))$ independent of ρ . By Ascoli-Arzelà's theorem, as $\rho \rightarrow 0$, we can extract a subsequence converging uniformly to a multi-valued graph $(\Theta_{ij}(z), \Xi_{ij}(z))$ and, as we said above, $\Xi_{ij}(z) \equiv 0$.

To complete the proof, we need to prove that this limit is unique, homogeneous and holomorphic in w .

In a way reminiscent of the discussion preceding 2.5.1, the unique connected component of $(z, (\varphi_i - \varphi_j)(z_l + \rho z), (\alpha_i - \alpha_j)(z_l + \rho z))$ (always with $i \neq j$ as in (2.57)) can be smoothly parametrized by a map from the unit disk $D^2 \subset \mathbb{C}$ into $D^2 \times \mathbb{C} \times \mathbb{R}$.

This can be achieved as follows. When the *difference vector* $(\varphi_i - \varphi_j, \alpha_i - \alpha_j)(z_l + \rho_0 z)$ (observed as an object in $\mathbb{C} \times \mathbb{C} \times \mathbb{R}$) evolves by continuity with a fixed ρ_0 as in figure 2.8, it comes back to the starting position after that the projection of its tail onto the first \mathbb{C} -factor has made I laps, for some integer I that depends on the branching order of L_l and L_k . So we can parametrize the multi-valued graph $(z, (\varphi_i - \varphi_j)(z_l + \rho_0 z), (\alpha_i - \alpha_j)(z_l + \rho_0 z))$ restricted to $\partial D^2 \times \mathbb{C} \times \mathbb{R}$ as a smooth curve from ∂D^2 into $\mathbb{C} \times \mathbb{C} \times \mathbb{R}$ of the form $(z^I, \phi_{lk}(z), a_{lk}(z))$. Now, by the smoothness of the current out of the isolated singularity, this map can be extended to a smooth map $(z^I, \phi_{lk}(z), a_{lk}(z))$ from $D^2 \setminus \{0\}$ into $\mathbb{C} \times \mathbb{C} \times \mathbb{R}$, describing $\{(z, (\varphi_i - \varphi_j)(z_l + \rho_0 z), (\alpha_i - \alpha_j)(z_l + \rho_0 z)) : |z| \leq 1\}$ on $(D^2 \setminus \{0\}) \times \mathbb{C} \times \mathbb{R}$.

By a standard computation we can translate (2.60) into a first order system for (ϕ_{lk}, a_{lk}) of the schematic form

$$\begin{cases} \bar{\partial} \phi_{lk}(z) + \tilde{\nu}(z) \partial \phi_{lk}(z) + \tilde{S}(z) \phi_{lk}(z) + \tilde{T}(z) a_{lk}(z) = 0 \\ \nabla a_{lk}(z) = \tilde{F}(z) \phi_{lk}(z) + \tilde{G}(z) a_{lk}(z) = 0 \end{cases}, \quad (2.61)$$

with $C^{1,\sigma}$ coefficients ($0 < \sigma < 1$) and $|\tilde{\nu}|$ small. Elliptic regularity yields that the extension of $(z^I, \phi_{lk}(z), a_{lk}(z))$ to D^2 , which is obviously continuous at 0, is actually at least C^2 .

Moreover, after the linear change of coordinates $z \rightarrow w$

$$w = \sqrt{\frac{1}{1 + |\nu(z_l)|^2}} z + \nu(z_l) \sqrt{\frac{1}{1 + |\nu(z_l)|^2}} \bar{z},$$

and by taking the ∂_w -derivative of the first equation, we get an inequality of the form

$$|\tilde{\Delta} \phi_{lk}|(w) \leq K |D \phi_{lk}|(w) + K |\phi_{lk}|(w),$$

where K is a positive constant and $\tilde{\Delta}$ is an elliptic second order operator that coincides with the Laplacian for $w = 0$. By elliptic theory, the function $f(\rho) := \|\phi_{lk}\|_{L^\infty(B_\rho^2)}$ cannot have derivatives at 0 all vanishing, see theorem 1.1 and corollary 1 on page 41 of [42] (this theorem is basically due to Hartman and Wintner).

Fix $z \in \partial D^2 \subset \mathbb{C}$. Then, since $f(\rho)$ is just $\|\varphi_i - \varphi_j\|_{L^\infty(B^2(z_l, \rho))}$, we can write

$$\Theta_{ij}(z) := \lim_{\rho \rightarrow 0} \Theta_{ij}^\rho(z) = \lim_{\rho \rightarrow 0} \frac{(\varphi_i - \varphi_j)(z_l + \rho z)}{f(\rho)} \quad (2.62)$$

and

$$\Theta_{ij}(\lambda z) := \lim_{\rho \rightarrow 0} \Theta_{ij}^\rho(\lambda z) = \lim_{\rho \rightarrow 0} \frac{(\varphi_i - \varphi_j)(z_l + \rho \lambda z)}{f(\rho)}. \quad (2.63)$$

This blow-up can be equivalently expressed in terms of ϕ_{lk} . What we are looking for in (2.62) and (2.63) are respectively $\Phi_{lk}(z) := \lim_{\rho \rightarrow 0} \frac{\phi_{lk}(\rho z)}{f(\rho)}$ and $\Phi_{lk}(\lambda z) = \lim_{\rho \rightarrow 0} \frac{\phi_{lk}(\lambda \rho z)}{f(\rho)}$. As we saw above, the function f is smooth and it is not possible that all of its derivatives at $\rho = 0$ vanish.

It is then enough to restrict to the segment joining z_l to z and apply De L'Hopital's theorem to compute the two limits: we get that there is $k \in \mathbb{N}$, namely the first integer such that $f^{(k)}(0) \neq 0$, for which $\Phi(\lambda z) = \lambda^k \Phi(z)$. This immediately gives $\Theta_{ij}(\lambda z) = \lambda^\tau \Theta_{ij}(z)$ for $\tau = \frac{k}{Q}$ and the uniqueness of the limit.

Moreover, it is not difficult to see that the convergence $\Theta_{ij}^\rho \rightarrow \Theta_{ij}$ is more than just uniform: indeed, the gradients are equibounded and equicontinuous, so we can pass (2.60) to the limit and get that $(\Theta_{ij}(z), \Xi_{ij}(z))$ must solve, locally on $\{0 < |z| \leq 1\}$,

$$\begin{cases} \bar{\partial} \Theta_{ij}(z) + \nu(z_l) \partial \Theta_{ij}(z) = 0, & \text{with } |\nu(z_l)| \ll 1, \\ \nabla \Xi_{ij}(z) = 0. \end{cases} \quad (2.64)$$

Therefore, since $(\Theta_{ij}(0), \Xi_{ij}(0)) = (0, 0)$, from the second equation we recover once again $(\Theta_{ij}(z), \Xi_{ij}(z))$ must be of the form $(\Theta_{ij}(z), 0)$. Consider now the equation for Θ_{ij} : again with the linear change of complex variable $z \rightarrow w$, we can deduce that Θ_{ij} solves

$$\frac{\partial}{\partial \bar{w}} \Theta_{ij}(w) = 0;$$

thus Θ_{ij} is holomorphic w.r.t. the variable w . We will also say that it is almost-holomorphic in z . □

The fact that Θ_{ij} is holomorphic in w and homogeneous implies that Θ_{ij} is always non-zero on ∂D^2 . Indeed, if we had a zero on $y \in \partial D^2$, Θ_{ij} would be zero on the whole segment joining 0 to y : recalling that there is a unique connected component and by holomorphicity we would then get that Θ_{ij} is zero on the whole of D^2 , contradicting that its L^∞ -norm is 1.

Lemma 2.5.2. Fix $(k, l) \in \{1, \dots, N\} \times \{1, \dots, N\}$; for $i \neq j$ s.t. (φ_i, α_i) belongs to a branch of L_k and (φ_j, α_j) to a branch of L_l (possibly with $k = l$), the following holds: for any $\delta > 0$ there is $\rho > 0$ small enough, s.t.

$$|z - z_l| < \rho \Rightarrow \frac{|\alpha_i - \alpha_j|^2}{|\varphi_i - \varphi_j|^2 + |\alpha_i - \alpha_j|^2}(z) < \delta.$$

In particular, for $|z - z_l| < \rho$ and $z \neq z_l$, we have $\varphi_i - \varphi_j \neq 0$ for $i \neq j$.

proof of lemma 2.5.2. By contradiction, if for some $\delta > 0$ and a sequence $z_n \rightarrow z_l$ we had $\frac{|\alpha_i - \alpha_j|^2}{|\varphi_i - \varphi_j|^2 + |\alpha_i - \alpha_j|^2}(z_n) \geq \delta$, the sequence

$$\left(\Theta_{ij}^{|z_n - z_l|}(z), \Xi_{ij}^{|z_n - z_l|}(z) \right)$$

could not converge to a limit of the form $(\Theta_{ij}(z), 0)$. \square

Lemma 2.5.3. Fix $(k, l) \in \{1, \dots, N\} \times \{1, \dots, N\}$; by lemma 2.5.2, for ρ small enough and for $i \neq j$ s.t. (φ_i, α_i) belongs to a branch of L_k and (φ_j, α_j) to a branch of L_l (possibly with $k = l$), it makes sense to compute the degree of

$$\frac{\varphi_i - \varphi_j}{|\varphi_i - \varphi_j|}$$

on the closed curve $\gamma = L_l \cap \pi^{-1}\{|z - z_l| = \rho\}$. This degree is strictly positive.

proof of lemma 2.5.3. See figure 2.8 for a visual explanation. γ is a closed, connected curve; orient it so that its projection $\pi(\gamma)$ on \mathbb{C} winds positively. Fix then, with an arbitrary starting point on γ , any determination of the vector $\varphi_i - \varphi_j$ and let it evolve along γ in the given direction, keeping its tail on the curve; meanwhile, its head will move along a closed curve in L_k , which could be either the same or a different curve. In the former case we are staying inside the same branched disk L_l , in the latter we are dealing with two different disks L_k and L_l . In any case, the vector will eventually come back to the initial one after having run, possibly more than once (say I times), over the whole of γ . We then get a smooth map $\frac{\varphi_i - \varphi_j}{|\varphi_i - \varphi_j|}$ from a multiple cover $\gamma \oplus \dots \oplus \gamma$ of γ to S^1 . The multiple cover is homeomorphic to S^1 , so it makes sense to consider the degree of the S^1 -valued map $\frac{\varphi_i - \varphi_j}{|\varphi_i - \varphi_j|}$ on $\gamma \oplus \dots \oplus \gamma$. Introduce the multi-valued graph $\varphi_i - \varphi_j$ for i, j in the L_k and L_l involved. This multi-valued graph has a unique connected component (or two symmetrical ones). By lemma 2.5.1

$$\frac{\varphi_i - \varphi_j}{|\varphi_i - \varphi_j|}(z_l + \rho z) = \frac{\Theta_{ij}^\rho}{|\Theta_{ij}^\rho|}(z) \rightarrow \frac{\Theta_{ij}}{|\Theta_{ij}|}(z)$$

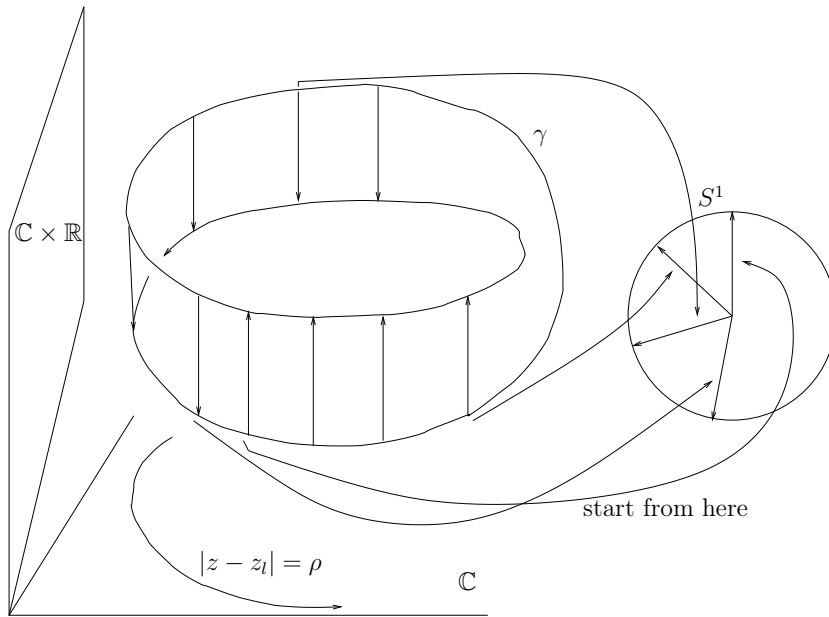

Figure 2.8: On the left, an attempt to represent $\gamma = \pi^{-1}\{|z - z_l| = \rho\}$ in the case of a two-valued graph in $\mathbb{C} \times \mathbb{C} \times \mathbb{R}$. We observe the evolution of the *difference vector* joining points above the same $z \in \{|z - z_l| = \rho\} \subset \mathbb{C}$: as the tail of the *difference vector* runs along γ , we keep track (picture on the right) of the normalized *difference vector* projected on the second \mathbb{C} -factor and observe how it winds around S^1 . If we are around an isolated singularity, then we find that the represented map from γ to S^1 has strictly positive degree. In this particular picture, after having run once along γ the normalized *difference vector* winds once positively around S^1 .

uniformly, so it must contribute with a strictly positive degree on $\gamma \oplus \dots \oplus \gamma$ if ρ was small enough, since so happens Θ_{ij} , which is almost-holomorphic. \square

Some heuristics. Roughly speaking, with lemmas 2.5.2 and 2.5.3 we have found out that, by observing the *relative differences between branches*, we can somehow “count” the points in $Sing^{\leq Q-1}$.

Indeed, locally around each $q \in Sing^{\leq Q-1}$, we have functions defined via the *relative differences of branches* that are able to catch the presence of p by producing a strictly positive integer contribution when the degree is observed.

However, both in the definition of these functions $\frac{\varphi_i - \varphi_j}{|\varphi_i - \varphi_j|}$ and in the proof of the strict positiveness of the degree, we made a key use of the structure (2.56) of C around an isolated singularity q . This allowed us, locally around q , a “separation of the branches”: we were able to focus just on the disks L_i

and L_k involved in the evolution of the *difference vector*. With the use of PDEs and parametrizations, we were lead to the results on Θ_{ij} and to the control on the degree.

Moreover we have produced a way to “count” singularities with functions that are only defined close enough to the singular point itself. As we get further from the singularity it might happen that the *difference vector* $(\varphi_i - \varphi_j, \alpha_i - \alpha_j)(z)$ has zero \mathbb{C} -component, so we cannot construct a global function that counts singularities by looking only at $\varphi_i - \varphi_j$.

With the notations taken at the beginning of this section, we are thus lead to the following questions:

- can we produce a similar function that is well-defined in a whole neighbourhood of $0 \in D^2$ and whose degree still detects the presence of points in $Sing^{\leq Q-1}$?
- can we find a lower bound for the degree of this function, to allow a homotopy argument as sketched in the introduction?

Remark that we have no information about the structure of C around the origin, unlike it happened in the situation (2.56). A natural candidate function on D^2 to collect the information on the degree of the *difference between branches* would be $(\prod_{i \neq j}(\varphi_i - \varphi_j), \prod_{i \neq j}(\alpha_i - \alpha_j))$. However this function does not solve any appealing equation.

To overcome this difficulty we are going to introduce a new 2-dimensional space π^*C that is modelled on the current C but allows to observe the *relative difference of branches* without having to separate them and, most important, with the use of this new space we will be able to write equations for the *difference of branches*: this will be crucial in answering the second question.

More precisely, due to dimensional reasons rooted in the problem, we will produce a function u on the space $\pi^*C \times \mathbb{R}$ taking values in $\mathbb{C} \times \mathbb{R}$: this function will mimic the behaviour of the *difference vector* when we are close enough to an isolated singularity.

Recalling the heuristic ideas from the introduction, we can see that the technical reason is that we need a function u that vanishes exactly at the singular points and for which we can take the degree of $\frac{u}{|u|}$: since the difference of branches is naturally an element of $\mathbb{C} \times \mathbb{R}$, we need to add an extra-dimension to π^*C in order to have a notion of topological degree.

The core of the proof of theorem 2.5.1 will be lemma 2.5.5, where we bound from below the degree of $\frac{u}{|u|}$. Lemma 2.5.4 is a restatement of lemma 2.5.3 in terms of the new space $\pi^*C \times \mathbb{R}$ and of the function u . These two results together allow the homological argument that yields theorem 2.5.1.

Proof of the non-accumulation. Denote by π^*C the following subset of $\mathbb{R}^3 \times \mathbb{R}^3 \times D^2$:

$$\pi^*C := \left\{ \begin{array}{l} \xi = (\zeta_1, \zeta_2, z) \in \mathbb{R}^3 \times \mathbb{R}^3 \times D^2 \quad \text{s.t.} \quad \exists j, k \in \{1 \cdots Q\} \\ \text{satisfying } \zeta_1 = (\varphi_j(z), \alpha_j(z)) \quad \text{and} \quad \zeta_2 = (\varphi_k(z), \alpha_k(z)) \end{array} \right\}.$$

By an abuse of notation we will also write $\zeta_1 = (\varphi_1, \alpha_1)$ and $\zeta_2 = (\varphi_2, \alpha_2)$, moreover²³ we denote $z = \pi(\xi)$ - i.e. π is extended naturally to π^*C .

Observe that $C \subset \pi^*C$ as the result of the identification of C with the points (ζ_1, ζ_2, z) such that $\zeta_1 = \zeta_2$. Away from these points, $\pi^*C \setminus C$ realizes a smooth 2-dimensional oriented submanifold of $\mathbb{R}^3 \times \mathbb{R}^3 \times D^2$ with local chart given by z .

On π^*C we define the function

$$d(\xi) := |\zeta_1 - \zeta_2| = \sqrt{|\alpha_1 - \alpha_2|^2 + |\varphi_1 - \varphi_2|^2} \quad ,$$

which is smooth and non-zero on $\pi^*C \setminus C$. On $\pi^*C \setminus C$ we define

$$\Delta(\xi) := \frac{|\alpha_1 - \alpha_2|^2}{|\alpha_1 - \alpha_2|^2 + |\varphi_1 - \varphi_2|^2} \quad .$$

Let ϕ be a smooth non negative compactly supported function satisfying

$$\phi(s) = \begin{cases} 1 & \text{for } s < 1, \\ 0 & \text{for } s > 2. \end{cases}$$

For $1 > \delta > 0$ we denote $\phi_\delta(\cdot) = \phi(\cdot/\delta)$.

Let $\delta < 1$ be a regular value of the function Δ on $\pi^*C \setminus C$ we define a *stretching-contracting map*

$$S_\delta : \mathbb{R}^3 \longrightarrow \mathbb{R}^3$$

in the following way : S_δ is axially symmetric about the z -axis, $|S_\delta(x, y, z)| = |(x, y, z)|$ and the following conditions are satisfied:

$$S_\delta(x, y, z) = \begin{cases} S_\delta(x, y, z) = \text{sgn}(z) (0, 0, \sqrt{x^2 + y^2 + z^2}) & \text{if } \frac{z^2}{x^2 + y^2 + z^2} > \delta, \\ S_\delta(x, y, z) = (x, y, z) & \text{if } \frac{z^2}{x^2 + y^2 + z^2} < \frac{\delta}{2}, \end{cases}$$

²³Here ζ_i ($i \in \{1, 2\}$) will always be an element of \mathbb{R}^3 of the form $(\varphi_j(z), \alpha_j(z))$; it should not be confused with the complex coordinate ζ in $\mathbb{C}_z \times \mathbb{C}_\zeta \times \mathbb{R}_a$ used in sections 2.4 and 2.4.5, which will anyway not appear in this section.

with a smooth join for $\frac{\delta}{2} \leq \frac{z^2}{x^2+y^2+z^2} \leq \delta$ chosen so to ensure $\det(DS_\delta) > 0$.

Denote by N the following 3-dimensional manifold:

$$N := \{(\xi, t) \in (\pi^*C \setminus C) \times \mathbb{R}\} \quad .$$

Set

$$D = D_\delta := \frac{1}{\sqrt{\frac{1}{\delta} - 1}} \quad .$$

Observe that $D > 0$ has been chosen in particular in such a way that

$$D^{-1} |\alpha_1 - \alpha_2| \leq |\varphi_1 - \varphi_2| \iff \Delta(\xi) \leq \delta \iff \phi_\delta(\Delta(\xi)) = 1 \quad . \quad (2.65)$$

At this stage we are going to make a short digression to choose a suitable value for $\delta < 1$ (besides the requirement that δ be a regular value of Δ), which will be kept throughout the rest of the section.

Let R be the radius of D^2 . Denote by B_r , for $r \leq R$, the part of $\pi^*C \setminus C$ above the set $\{|z| < r\}$, $B_r := \pi^{-1}(B_r^2(0))$. For any $\delta < 1$, express the set $\{\Delta > \delta\}$ as the union of its connected components, i.e. $\{\Delta > \delta\} = \cup_i A_\delta^i$. We are going to prove the following claim: there exist $\delta < 1$ and $\bar{r} < R$ s.t.

$$\forall i \quad \text{and} \quad \forall r \leq \bar{r} \quad A_\delta^i \cap \partial B_r \neq \emptyset \Rightarrow A_\delta^i \cap \partial B_R = \emptyset. \quad (2.66)$$

To prove the claim, we argue by contradiction: assume the existence of sequences $\delta_n \rightarrow 1$, $r_n \rightarrow 0$ for which we can always find a connected component intersecting both ∂B_{r_n} and ∂B_R . Then we can choose C^1 curves γ_n , parametrized by arc length, joining ∂B_{r_n} to ∂B_R and staying inside the corresponding connected component. Up to a subsequence, by Ascoli-Arzelà's theorem, we can assume the existence of a uniform limit curve γ , joining 0 to ∂B_R . The function Δ is greater than δ_n on the image of γ_n , therefore

$$\delta_n \rightarrow 1 \Rightarrow \Delta \circ \gamma \equiv 1 \Rightarrow |\varphi_1 - \varphi_2| \rightarrow 0 \text{ as } n \rightarrow \infty.$$

The limit curve γ could a priori be merely continuous and not C^1 . We can write, from (2.58), for any n and for any t in the domain of γ_n :

$$|\alpha_1 - \alpha_2|(\gamma_n(t)) \leq |\varphi_1 - \varphi_2|(\gamma_n(0)) + K_0 \int_0^t |\alpha_1 - \alpha_2|(\gamma_n(s)) ds.$$

Sending to the limit as $n \rightarrow \infty$

$$|\alpha_1 - \alpha_2|(\gamma(t)) \leq K_0 \int_0^t |\alpha_1 - \alpha_2|(\gamma(s)) ds,$$

thus $\alpha_1 - \alpha_2$ is identically 0 on the curve γ ; here $\varphi_1 - \varphi_2$ also vanishes and therefore the image of γ is a line of singularities, contradiction. Thus the claim is proved. End of the digression.

Now, for the δ just chosen, take any positive $r \leq \bar{r}$ arbitrarily small and such that $\pi^{-1}(\partial B_r^2(0))$ does not intersect the set of z_l satisfying (2.54). Let

$$\varepsilon_0 := \inf \left\{ \frac{d(\xi)}{\sqrt{1+D^2}} ; \xi \in (\pi^*C \setminus C) \cap \pi^{-1}(\partial B_r^2(0)) \right\} .$$

By the assumption on r , $\varepsilon_0 > 0$.

Let $\varepsilon > 0$ be a regular value less than ε_0 for the function $|\varphi_1 - \varphi_2|$. Denote by g the following function on $\pi^*C \setminus C$:

$$g(\xi) := \frac{\varphi_1 - \varphi_2}{\max\{|\alpha_1 - \alpha_2|, D\varepsilon\}} .$$

Observe that since $(C \llcorner B^5) \setminus \{0\}$ is assumed to be a smooth Special Legendrian curve and since $(\varphi_j(0), \alpha_j(0)) = (0, 0)$ for all j , $|\varphi_1 - \varphi_2|^{-1}(\{\varepsilon\})$ is a smooth compact curve in $\pi^*C \setminus C$ for any regular value $\varepsilon > 0$. Observe moreover that since $\varepsilon < \varepsilon_0$ we have that

$$(\pi^*C \setminus \{\xi ; \Delta(\xi) > \delta\}) \cap (|\varphi_1 - \varphi_2|^{-1}(\{\varepsilon\})) \cap \pi^{-1}(\partial B_r^2(0)) = \emptyset . \quad (2.67)$$

Define the open set U in $\pi^*C \setminus C$ made of the connected components of $\{\Delta > \delta\}$ that intersect $B_r = \pi^{-1}(B_r^2(0))$ (and therefore not ∂B_R thanks to (2.66)).

For any fixed $r \leq \bar{r}$, choose ε small enough as follows: firstly, $\varepsilon < \varepsilon_0$; secondly, take

$$\varepsilon < \min \left\{ |\varphi_1 - \varphi_2|(\xi) : \xi \in \overline{\partial(U \cap (B_R \setminus B_r)) \setminus \partial B_r} \subset \partial U \right\} .$$

The minimum on the r.h.s. is strictly positive. Indeed, if it were 0, then either we would have a singular point that realizes it, or a smooth point where $\Delta = 1$. In the former case, lemma 2.5.2 tells us that there is a neighbourhood of the singularity where $\{\Delta < \frac{\delta}{2}\}$, therefore it cannot be a boundary point of U , since in U we have $\Delta > \delta$. In the latter case there ought to be a neighbourhood where $\{\Delta > \delta\}$, so it could not be a boundary point.

Finally define the open set in $\pi^*C \setminus C$

$$\Sigma_{\varepsilon,r} = (\{|\varphi_1 - \varphi_2| < \varepsilon\} \cap B_r) \cup U.$$

$\Sigma_{\varepsilon,r}$ has the following properties:

(i)

$z_l \in \pi(\Sigma_{\varepsilon,r}) \Rightarrow z_l \in \pi(B_r)$, since there are no singularities in U
due to lemma 2.5.2;

(ii)

$$p \in \partial\Sigma_{\varepsilon,r} \Rightarrow \begin{cases} |\varphi_1 - \varphi_2|(p) = \varepsilon \\ \Delta(p) \leq \delta \end{cases} \quad \text{or} \quad \begin{cases} |\varphi_1 - \varphi_2|(p) \geq \varepsilon \\ \Delta(p) = \delta \end{cases},$$

so $|g| \equiv \sqrt{\frac{1}{\delta} - 1} = D^{-1}$ on $\partial\Sigma_{\varepsilon,r}$.

Thus δ and ε have been chosen in such a way that $\partial\Sigma_{\varepsilon,r}$ is a closed smooth compact curve in $\pi^*C \setminus C$ which is included in the level set $|g|^{-1}(\{D^{-1}\})$. Remark that $\partial\Sigma_{\varepsilon,r}$ is obtained by homotopy from the loop $\pi^{-1}\{|z| = r\}$ without crossing any singularity of $C \subset \pi^*C$.

On N we define the map v given by

$$v : N \longrightarrow S^2$$

$$(\xi, t) \longrightarrow \frac{(g(\xi), \alpha_1 - \alpha_2 + t \phi_\delta \circ \Delta(\xi))}{\sqrt{|g(\xi)|^2 + |\alpha_1 - \alpha_2 + t \phi_\delta \circ \Delta(\xi)|^2}}.$$

Observe that $|g(\xi)|^2 + |\alpha_1 - \alpha_2 + t \phi_\delta \circ \Delta(\xi)|^2 = 0$ implies that $|\varphi_1 - \varphi_2| = 0$. If $\alpha_1 - \alpha_2 \neq 0$ then $\phi_\delta \circ \Delta(\xi) = 0$ and hence we would have $|\alpha_1 - \alpha_2| = 0$ which is a contradiction. Hence v is well-defined smooth map on N . Finally define the S^2 -valued map u by

$$u := S_\delta \circ v : N \rightarrow S^2.$$

On the complement of $\Sigma_{\varepsilon,r}$ the map v simplifies to

$$v(\xi) = \frac{(g(\xi), \alpha_1 - \alpha_2 + t)}{\sqrt{|g(\xi)|^2 + |\alpha_1 - \alpha_2 + t|^2}}. \quad (2.68)$$

From the definition of S_δ , for any two-form ω on S^2 we have hence that, on $N \setminus (\Sigma_{\varepsilon,r} \times \mathbb{R})$, $(S_\delta \circ v)^* \omega = 0$ for $|t| > 1/\varepsilon$ (Assuming without loss of generality that $d(\xi)$ is bounded by 1 on π^*C). Hence the degree of u restricted to any closed compact curve in the complement of $\Sigma_{\varepsilon,r}$ times \mathbb{R} is well defined since in $N \setminus (\Sigma_{\varepsilon,r} \times \mathbb{R})$ we have $u^* \omega \neq 0$ only on a compact set.

The rest of the section is occupied with the proof of the following two lemmas, which will imply by a simple homotopy argument that can be found at the end of the section, that the number of z_l is uniformly bounded and theorem 2.5.1 will be proved.

Lemma 2.5.4. *For any z_l as in (2.54) and for $\rho > 0$ small enough*

$$\int_{\pi^{-1}(\partial B_\rho^2(z_l)) \times \mathbb{R}} u^* \omega \geq 1, \quad (2.69)$$

where ω is an arbitrary 2-form on S^2 such that $\int_{S^2} \omega = 1$.

Lemma 2.5.5. *Under the previous notations, there exists a constant $K \in \mathbb{R}^+$ independent of r and ε such that (the indexes of the two-form are to be understood mod 3)*

$$\int_{\partial \Sigma_{\varepsilon,r} \times \mathbb{R}} u^* \left(\sum_{i=1}^3 x^i dx^{i+1} \wedge dx^{i-1} \right) \geq -K \quad . \quad (2.70)$$

proof of lemma 2.5.5. This constitutes the core of the proof of theorem 2.5.1.

Recall that $|g(\xi)| \equiv D^{-1}$ on $\partial \Sigma_{\varepsilon,r}$. Denote λ the following function on $\Sigma_{\varepsilon,r} \times \mathbb{R}$

$$\lambda(\xi, t) := \sqrt{D^{-2} + (\alpha_1 - \alpha_2 + t)^2} \quad .$$

We additionally denote by w the following $\mathbb{C} \times \mathbb{R}$ -valued map²⁴ on $\Sigma_{\varepsilon,r} \times \mathbb{R}$:

$$w(\xi, t) := \frac{(g(\xi), \alpha_1 - \alpha_2 + t)}{\lambda}.$$

Observe that $w = v$ on $\partial \Sigma_{\varepsilon,r} \times \mathbb{R}$.

First we claim that

$$\int_{\Sigma_{\varepsilon,r} \times \mathbb{R}} |(S_\delta \circ w)^*(dx^1 \wedge dx^2 \wedge dx^3)| d\mathcal{H}^2 dt \llcorner N < +\infty \quad . \quad (2.71)$$

We now prove the claim (2.71). We write on one hand

$$S_\delta^*(dx^1 \wedge dx^2 \wedge dx^3) = \det(DS_\delta)(y) dy^1 \wedge dy^2 \wedge dy^3$$

and locally on the other hand

$$\begin{aligned} w^*(dy^1 \wedge dy^2 \wedge dy^3) &= \lambda^{-3} df^1 \wedge df^2 \wedge d(\alpha_1 - \alpha_2 + t) + \\ &+ \lambda^{-2} d\lambda^{-1} \wedge (f^1 df^2 - f^2 df^1) \wedge d(\alpha_1 - \alpha_2 + t) + \\ &+ \lambda^{-2} (\alpha_1 - \alpha_2 + t) df^1 \wedge df^2 \wedge d\lambda^{-1}, \end{aligned} \quad (2.72)$$

²⁴Sometimes we will also look at w as a \mathbb{R}^3 -valued map.

where $\mathbf{1}_{|\alpha_1 - \alpha_2| > D\varepsilon}$ is the characteristic function of the set where $|\alpha_1 - \alpha_2| > D\varepsilon$. Inserting now (2.78) in (2.79) we obtain

$$\begin{aligned} \partial_{\bar{z}} f &= \nu(\varphi_2, \alpha_2) \frac{\partial_z(\varphi_1 - \varphi_2)}{\max\{|\alpha_1 - \alpha_2|, D\varepsilon\}} + \frac{[\nu(\varphi_1, \alpha_1) - \nu(\varphi_2, \alpha_2)]}{\max\{|\alpha_1 - \alpha_2|, D\varepsilon\}} \partial_z a_1 \\ &+ \frac{\mu(\varphi_1, \alpha_1) - \mu(\varphi_2, \alpha_2)}{\max\{|\alpha_1 - \alpha_2|, D\varepsilon\}} - f \mathbf{1}_{|\alpha_1 - \alpha_2| > D\varepsilon} \frac{\partial_{\bar{z}}|\alpha_1 - \alpha_2|}{\max\{|\alpha_1 - \alpha_2|, D\varepsilon\}} . \end{aligned} \quad (2.80)$$

From (2.80) we deduce

$$\begin{aligned} \partial_{\bar{z}} f &= \nu(\varphi_2, \alpha_2) \partial_z f + \nu(\varphi_2, \alpha_2) f \mathbf{1}_{|\alpha_1 - \alpha_2| > D\varepsilon} \frac{\partial_z|\alpha_1 - \alpha_2|}{\max\{|\alpha_1 - \alpha_2|, D\varepsilon\}} + \\ &+ \frac{[\nu(\varphi_1, \alpha_1) - \nu(\varphi_2, \alpha_2)]}{\max\{|\alpha_1 - \alpha_2|, D\varepsilon\}} \partial_z a_1 + \frac{\mu(\varphi_1, \alpha_1) - \mu(\varphi_2, \alpha_2)}{\max\{|\alpha_1 - \alpha_2|, D\varepsilon\}} - \\ &- f \mathbf{1}_{|\alpha_1 - \alpha_2| > D\varepsilon} \frac{\partial_{\bar{z}}|\alpha_1 - \alpha_2|}{\max\{|\alpha_1 - \alpha_2|, D\varepsilon\}} . \end{aligned} \quad (2.81)$$

Using now the second equation in (2.78) we obtain the existence of a constant $K_0 > 0$ such that

$$|\nabla(\alpha_1 - \alpha_2)| \leq K_0 [|\varphi_1 - \varphi_2| + |\alpha_1 - \alpha_2|] . \quad (2.82)$$

This later fact gives

$$\left| \frac{\nabla(\alpha_1 - \alpha_2)}{\max\{|\alpha_1 - \alpha_2|, D\varepsilon\}} \right| \leq K_0 [|f| + 1] . \quad (2.83)$$

Combining (2.81) and (2.83) we obtain the following bound : there exists $K_1 > 0$ and $K_2 > 0$ such that

$$|\partial_{\bar{z}} f - \nu(\varphi_2, \alpha_2) \partial_z f| \leq K_1 [|f| + 1] |\partial_z \varphi_1| + K_2 [|f|^2 + 1] . \quad (2.84)$$

From (2.75) we have that

$$\begin{aligned} &\int_{\Sigma_{\varepsilon, r} \times \mathbb{R}} (S_\delta \circ w)^*(dx^1 \wedge dx^2 \wedge dx^3) = \\ &= \left(\int_{\pi(\Sigma_{\varepsilon, r})} D^{-2} [|\partial_z f|^2 - |\partial_{\bar{z}} f|^2] \frac{i}{2} dz \wedge d\bar{z} \right) \left(\int_{-\infty}^{+\infty} \det(DS_\delta) \circ w \lambda^{-5} dt \right) . \end{aligned} \quad (2.85)$$

Since $\det(DS_\delta)(y) \geq 0$ on \mathbb{R}^3 ,

$$\eta(z) := \int_{-\infty}^{+\infty} \det(DS_\delta) \circ w \lambda^{-5} dt \geq 0 .$$

Moreover we also have the following bound given by (2.76)

$$\eta \leq C_D = C_\delta \quad . \quad (2.86)$$

Using (2.84) we then deduce the following lower bound:

$$\begin{aligned} & \int_{\Sigma_{\varepsilon,r} \times \mathbb{R}} (S_\delta \circ w)^*(dx^1 \wedge dx^2 \wedge dx^3) \geq \\ & \geq \int_{\pi(\Sigma_{\varepsilon,r})} D^{-2} [1 - \nu^2(\varphi_2, \alpha_2) |\partial_z f|^2] \eta \frac{i}{2} dz \wedge d\bar{z} - \\ & - \tilde{C}_\delta \int_{\pi(\Sigma_{\varepsilon,r})} [4(K_1)^2 (|f| + 1)^2 |\partial_z \varphi_1|^2 + 4(K_2)^2 (|f|^2 + 1)^2] \frac{i}{2} dz \wedge d\bar{z} \quad . \end{aligned} \quad (2.87)$$

Using the fact that $|f(z)| = |g(\xi)| \leq D^{-1}$ on $\Sigma_{\varepsilon,r}$, and that, for r small enough $|\nu(\varphi_2, \alpha_2)| < 1/2$, we obtain the existence of a constant K_δ such that

$$\begin{aligned} & \int_{\Sigma_{\varepsilon,r} \times \mathbb{R}} (S_\delta \circ w)^*(dx^1 \wedge dx^2 \wedge dx^3) \geq \\ & \geq -K_\delta \int_{D^2} \sum_{j=1}^Q [|\nabla \varphi_j|^2 + 1] \frac{i}{2} dz \wedge d\bar{z} \geq -K, \end{aligned} \quad (2.88)$$

with $K > 0$ independent of r and ε .

Recall now that $w = v$ on $\partial\Sigma_{\varepsilon,r} \times \mathbb{R}$. Then by Stokes theorem

$$\begin{aligned} \int_{\Sigma_{\varepsilon,r} \times \mathbb{R}} (S_\delta \circ w)^*(dx^1 \wedge dx^2 \wedge dx^3) &= \int_{\partial\Sigma_{\varepsilon,r} \times \mathbb{R}} (S_\delta \circ w)^* \left(\sum_{i=1}^3 x^i dx^{i+1} \wedge dx^{i-1} \right) = \\ &= \int_{\partial\Sigma_{\varepsilon,r} \times \mathbb{R}} (S_\delta \circ v)^* \left(\sum_{i=1}^3 x^i dx^{i+1} \wedge dx^{i-1} \right). \end{aligned}$$

This is the desired lower bound (2.70) and lemma 2.5.5 is proved. \square

proof of lemma 2.5.4. The result follows straight from lemma 2.5.3. Observe that, by lemma 2.5.2 and by homotopy, the degree computed there is the same as the degree of the function

$$\frac{\varphi_i - \varphi_j}{D\varepsilon} = \frac{\varphi_i - \varphi_j}{\max\{|\alpha_i - \alpha_j|, D\varepsilon\}} = g$$

on the loop $\{|\phi_i - \phi_j| = \varepsilon\}$ around z_l . By the same computation performed in (2.85) (we can take without loss of generality $\omega = \sum_{i=1}^3 x^i dx^{i+1} \wedge dx^{i-1}$), since the degree of g is exactly $\int_{\pi(\Sigma_{\varepsilon,r})} D^{-2} [|\partial_z f|^2 - |\partial_{\bar{z}} f|^2] \frac{i}{2} dz \wedge d\bar{z}$, we get that the degree of $S_\delta \circ w$ is strictly positive. \square

proof of theorem 2.5.1. We argue by contradiction. If we had countably many singularities of the form (2.54) accumulating onto 0, around each such singular point, on $\pi^{-1}(\partial B_\rho^2(z_l)) \times \mathbb{R}$, we would have a strictly positive degree for u , thanks to lemma 2.5.4. Let us observe, however, the degree of u on $\partial B_r \times \mathbb{R}$; this is the same as the degree of u on $\partial \Sigma_{r,\varepsilon} \times \mathbb{R}$, since these two 2-surfaces are homotopic and we do not cross any singularity during this homotopy (see (ii) on page 64 and recall that u is smooth out of the singularities). Choosing r smaller and smaller, we must then have, under the contradiction assumption, that the degree of u on $\partial B_r \times \mathbb{R}$ goes to $-\infty$ as $r \rightarrow 0$, which contradicts lemma 2.5.5. \square

Chapter 3

Semi-calibrated Legendrians in a contact 5-manifold

As described in section 1.5.2, the result of the previous chapter is generalized here to contact 5-manifolds (\mathcal{M}^5, α) with certain almost complex structures. The content of this chapter is [5].

We recall the setting (the description partially overlaps with the presentation in the introduction). Let $\mathcal{M} = \mathcal{M}^5$ be a five-dimensional contact manifold with contact form α . We will assume \mathcal{M} oriented by the top-dimensional form $\alpha \wedge (d\alpha)^2$.

The contact distribution (also called horizontal distribution) H of 4-dimensional hyperplanes $\{H_p\}_{p \in \mathcal{M}}$ defined by

$$H_p := \text{Ker } \alpha_p \tag{3.1}$$

is non-integrable by (1.6). The integral submanifolds of maximal dimension for the contact structure are of dimension two and are called *Legendrians*.

Given an almost-complex structure J on the horizontal distribution and a horizontal, non-degenerate two-form β , we say that J is compatible with β if:

$$\beta(v, w) = \beta(Jv, Jw), \quad \beta(v, Jv) > 0 \quad \text{for any } v, w \in H. \tag{3.2}$$

In this situation, we can define an associated Riemannian metric $g_{J, \beta}$ on the horizontal sub-bundle by setting

$$g_{J, \beta}(v, w) := \beta(v, Jw).$$

We can extend J to an endomorphism of the tangent bundle $T\mathcal{M}$ by setting

$$J(R_\alpha) = 0. \tag{3.3}$$

and the metric to a Riemannian metric on the tangent bundle by

$$g := g_{J,\beta} + \alpha \otimes \alpha. \quad (3.4)$$

The Reeb vector field R_α is orthogonal to the hyperplanes H for the metric g .

The following example will be important for the proof of the main result of this chapter.

Example (the *standard contact structure* on \mathbb{R}^5).

Using coordinates (x_1, y_1, x_2, y_2, t) the standard contact form is $\zeta = dt - (y_1 dx^1 + y_2 dx^2)$. The expression for $d\zeta$ is $dx^1 dy^1 + dx^2 dy^2$ and the horizontal distribution is given by

$$Ker \zeta = Span\{\partial_{x_1} + y_1 \partial_t, \partial_{x_2} + y_2 \partial_t, \partial_{y_1}, \partial_{y_2}\}. \quad (3.5)$$

The standard almost complex structure I compatible with $d\zeta$ is the endomorphism

$$\begin{cases} I(\partial_{x_i} + y_i \partial_t) = \partial_{y_i} \\ I(\partial_{y_i}) = -(\partial_{x_i} + y_i \partial_t) \end{cases} \quad i \in \{1, 2\}. \quad (3.6)$$

I and $d\zeta$ induce, as described above, the metric $g_\zeta := d\zeta(\cdot, I\cdot) + \alpha(\cdot)\alpha(\cdot)$ for which the hyperplanes $Ker \zeta$ are orthogonal to the t -coordinate lines, which are the integral curves of the Reeb vector field. The metric g_ζ projects down to the standard euclidean metric on \mathbb{R}^4 , so the projection

$$\begin{aligned} \pi : \mathbb{R}^5 &\rightarrow \mathbb{R}^4 \\ (x_1, y_1, x_2, y_2, t) &\rightarrow (x_1, y_1, x_2, y_2) \end{aligned} \quad (3.7)$$

is an isometry from (\mathbb{R}^5, g_ζ) to (\mathbb{R}^4, g_{eucl}) .

The following will be useful in the sequel:

Remark 3.0.3. Observing (3.5), we can see that, for any $q \in \mathbb{R}^4$, all the hyperplanes $H_{\pi^{-1}(q)}$ are parallel in the standard euclidean space \mathbb{R}^5 . Thus the lift of a vector in $\mathbb{R}^4 = \{t = 0\}$ with base-point q to an horizontal vector based at any point of the fiber $\pi^{-1}(q)$ has always the same coordinate expression along this fiber.

As discussed in section 1.5.2, we will be interested in two-dimensional Legendrians which are invariant for suitable almost complex structures defined on the horizontal distribution. What we require for an almost-complex structure J on the horizontal sub-bundle is the following **Lagrangian condition**

$$d\alpha(Jv, v) = 0 \text{ for any } v \in H. \quad (3.8)$$

This requirement amounts to asking that any J -invariant 2-plane must be Lagrangian for the symplectic form $d\alpha$. It is also equivalent to the following **anti-compatibility condition**

$$d\alpha(v, w) = -d\alpha(Jv, Jw) \text{ for any } v, w \in H. \quad (3.9)$$

It is immediate that (3.9) implies (3.8). On the other hand, using (3.8):

$$\begin{aligned} 0 = d\alpha(J(v+w), v+w) &= d\alpha(Jv, v) + d\alpha(Jw, w) + d\alpha(Jv, w) + d\alpha(Jw, v) = \\ &= d\alpha(Jv, w) + d\alpha(Jw, v), \end{aligned}$$

so

$$d\alpha(Jv, w) = d\alpha(v, Jw) \text{ for any horizontal vectors } v \text{ and } w.$$

Writing this with Jv instead of v , and being J an endomorphism of H , we obtain (3.9).

The main result we present is the following

Theorem 3.0.2. *Let \mathcal{M} be a five-dimensional manifold endowed with a contact form α and let J be an almost-complex structure defined on the horizontal distribution $H = \text{Ker } \alpha$, such that $d\alpha(Jv, v) = 0$ for any $v \in H$.*

Let C be an integer multiplicity rectifiable cycle of dimension 2 in \mathcal{M} such that \mathcal{H}^2 -a.e. the approximate tangent plane $T_x C$ is J -invariant¹.

Then C is, except possibly at isolated points, the current of integration along a smooth two-dimensional Legendrian curve.

In chapter 2 we proved the corresponding regularity property for Special Legendrian Integral cycles² in S^5 . From Proposition 2 in chapter 2, it follows that theorem 3.0.2 applies in particular to Special Legendrians in S^5 and therefore generalizes that result.

Here we looked for a natural general setting in which an analysis analogous to the one in the previous chapter could be performed. This lead to the assumptions taken above, in particular to conditions (3.8) and (3.9).

¹Representing a 2-plane as a simple 2-vector $v \wedge w$, the condition of J -invariance means $v \wedge w = Jv \wedge Jw$. With (3.3) in mind, we see that a J -invariant 2-plane must be tangent to the horizontal distribution.

²Special Legendrian cycles are briefly described in section 3.3, where the reader may also find other examples where theorem 3.0.2 applies.

In **Proposition 4** of the present chapter we describe a direct application of this theorem to semi-calibrations. The cycles under investigations are indeed generally *almost-minimizers* (also called λ -*minimizers*) of the area functional: in the last section we will see some cases when they are also *minimal*, in the sense of vanishing mean curvature.

We will need to construct families of 3-dimensional surfaces³ which locally foliate the 5-dimensional ambient manifold and that have the property of **intersecting positively** the Legendrian, J -invariant cycles.

After having achieved this by solving a perturbation of Laplace's equation, the proof of theorem 3.0.2 can be completed by following that in the previous chapter verbatim: an overview is presented at the end of section 4.4. To prove the existence of a solution to the perturbed Laplace's equation, we need to work in adapted coordinates (see proposition 5 and the discussion which precedes it).

The results needed for the proof of theorem 3.0.2 are in section 4.4 and the reader may go straight to that. In section 3.1 we show the existence of J -structures satisfying (3.8) or (3.9) and discuss how they are related to 2-forms, in particular to semi-calibrations. In the last section we discuss examples and possible applications of theorem 3.0.2.

3.1 Almost complex structures and two-forms.

3.1.1 Self-dual and anti self-dual forms.

On a contact 5-manifold (\mathcal{M}, α) , take an almost-complex structure I compatible with the symplectic form $d\alpha$, and let g be the metric defined by $g(v, w) := d\alpha(v, Iw) + \alpha \otimes \alpha$.

The metric g induces a metric on the horizontal sub-bundle H , which also inherits an orientation from \mathcal{M} .

Any horizontal two-form can be split in its self-dual and anti self-dual parts as follows.

Let \star be the Hodge-star operator acting on the cotangent bundle $T^*\mathcal{M}$. Define the operator

$$\star : \Lambda^2(T\mathcal{M}) \rightarrow \Lambda^2(T\mathcal{M}), \quad \star(\beta) := *(\alpha \wedge \beta), \quad (3.10)$$

and remark that \star naturally restricts to an automorphism of the space of horizontal forms $\Lambda^2(H)$:

$$\star : \Lambda^2(H) \rightarrow \Lambda^2(H), \quad \star(\beta) := *(\alpha \wedge \beta). \quad (3.11)$$

³This existence result is where (3.8) and (3.9) play a determinant role.

This operator satisfies $\star^2 = id$.

This yields the orthogonal eigenspace decomposition

$$\Lambda^2(H) = \Lambda_+^2(H) \oplus \Lambda_-^2(H), \tag{3.12}$$

where $\Lambda_{\pm}^2(H)$ is the eigenspace relative to the eigenvalue ± 1 of \star . These eigenspaces are referred to as the space of *self-dual* and the space of *anti self-dual* two-forms⁴.

In other words, we can restrict to the horizontal sub-bundle with the inherited metric and orientation and define the Hodge-star operator on horizontal forms by using the same definition as the general one, but confining ourselves to the horizontal forms. We get just the \star defined above.

3.1.2 From a two-form to J .

In a contact 5-manifold (\mathcal{M}, α) , given a horizontal two-form ω (with some conditions), is there an almost complex structure compatible with ω and satisfying $d\alpha(Jv, v) = 0$ for any $v \in H$?

In this section, by answering positively the above question, we will also establish the existence of such *anti-compatible* almost complex structures.

Assume that, on a contact 5-manifold (\mathcal{M}, α) , a two-form ω is given, that satisfies

$$\omega \wedge d\alpha = 0 \tag{3.13}$$

and

$$\omega \wedge \omega \neq 0. \tag{3.14}$$

Conditions (3.13) and (3.14) automatically give that ω is horizontal⁵, $\iota_{R\alpha}\omega = 0$. Without loss of generality, we may assume that

$$\omega \wedge \omega = f(d\alpha)^2 \text{ for a strictly positive}^6 \text{ function } f. \tag{3.15}$$

Take an almost-complex structure I compatible with the symplectic form $d\alpha$, and let $g = g_{d\alpha, I}$ be the metric defined by $g(v, w) := d\alpha(v, Iw) + \alpha \otimes \alpha$.

Decompose $\omega = \omega_+ + \omega_-$, where ω_+ is the self-dual part and ω_- is the anti self-dual part. By definition $d\alpha$ is self-dual for g : so we have

$$\omega_- \wedge d\alpha = \langle \omega_-, d\alpha \rangle dvol_{g|_H} = 0,$$

⁴This is basically how self-duality was defined in [59].

⁵This can be checked in coordinates pointwise. Alternatively one can adapt the proof of [13], Proposition 2.

⁶Indeed, the non-zero condition in (3.14) implies that (3.15) holds with f either everywhere positive or everywhere negative. The case $f < 0$ can be treated after a change of orientation on \mathcal{M} just in the same way.

since Λ_+^2 and Λ_-^2 are orthogonal subspaces. Therefore (3.13) can be restated as

$$\omega_+ \wedge d\alpha = 0. \quad (3.16)$$

Consider now the form⁷

$$\tilde{\omega}_+ := \frac{\sqrt{2}}{\|\omega_+\|} \omega_+.$$

It is self-dual and of norm $\sqrt{2}$, so there exists a unique almost complex structure on the horizontal bundle that is compatible with g and $\tilde{\omega}_+$. It is defined by

$$J := g^{-1}(\tilde{\omega}_+).$$

We want to show that $d\alpha(Jv, v) = 0$ for any $v \in H$.

To this aim, it is enough to work pointwise in coordinates. We can choose an orthonormal basis for H (at the chosen point) of the form $\{e_1 = X, e_2 = IX, e_3 = Y, e_4 = IY\}$ and denote by

$$\{e^1, e^2, e^3, e^4\} \quad (3.17)$$

the dual basis of orthonormal one-forms. Then $d\alpha$ has the form $e^{12} + e^{34}$, where we use e^{ij} as a short notation for $e^i \wedge e^j$. The forms $e^{12} + e^{34}$, $e^{13} + e^{42}$ and $e^{14} + e^{23}$ are an orthonormal basis for Λ_+^2 . The fact that ω_+ is orthogonal to $d\alpha$ implies that

$$\omega_+ = a(e^{13} + e^{42}) + b(e^{14} + e^{23}). \quad (3.18)$$

and $\|\omega_+\|^2 = 2(a^2 + b^2)$, therefore $\tilde{\omega}_+ = \cos \theta(e^{13} + e^{42}) + \sin \theta(e^{14} + e^{23})$ for some θ depending on the chosen point, $\cos \theta = \frac{a}{\sqrt{a^2+b^2}}$, $\sin \theta = \frac{b}{\sqrt{a^2+b^2}}$. Then the explicit expression for J is

$$\begin{aligned} J(e_1) &= \cos \theta e_3 + \sin \theta e_4 \\ J(e_2) &= -\cos \theta e_4 + \sin \theta e_3 \\ J(e_3) &= -\cos \theta e_1 - \sin \theta e_2 \\ J(e_4) &= \cos \theta e_2 - \sin \theta e_1 \end{aligned} \quad (3.19)$$

and an easy computation shows that $d\alpha(v, J(v)) = 0$ for any $v \in H$.

⁷The notation $\|\cdot\|$ denotes here the standard norm for differential forms coming from the metric on the manifold. It should not be confused with the comass, which is denoted by $\|\cdot\|^*$. They are in general different: for example, in \mathbb{R}^4 with the euclidean metric and standard coordinates (x_1, x_2, x_3, x_4) , the 2-form $\beta = dx^1 \wedge dx^2 + dx^3 \wedge dx^4$ has norm $\|\beta\| = \sqrt{2}$ and comass $\|\beta\|^* = 1$.

Next we prove that this J is compatible with ω , in the sense of (3.2).

The almost complex structure J is surely compatible with ω_+ , since this form is just a scalar multiple of $\tilde{\omega}_+$, and the metric associated to $(\tilde{\omega}_+, J)$ is $\frac{\|\omega_+\|}{\sqrt{2}}g$ when restricted to the horizontal bundle.

Let us now look at ω_- . It is interesting to observe that

$$\omega_-(v, w) = \omega_-(Jv, Jw). \quad (3.20)$$

This can be once again checked pointwise in coordinates, as above. An orthonormal basis for Λ_+^2 is given by the forms $e^{12} - e^{34}$, $e^{13} - e^{42}$ and $e^{14} - e^{23}$, therefore ω_- is a linear combination of these forms, each of which can be checked to satisfy the invariance expressed in (3.20) with respect to J .

On the other hand, these anti self-dual forms do not give a positive real number when applied to (v, Jv) for an arbitrary $v \in H$. However, due to (3.15) we can show that $\omega(v, Jv) = \omega_+(v, Jv) + \omega_-(v, Jv) > 0$ for any v .

Indeed, write again

$$\omega_+ = a(e^{13} + e^{42}) + b(e^{14} + e^{23}), \quad (3.21)$$

$$\omega_- = A(e^{12} - e^{34}) + B(e^{13} - e^{42}) + C(e^{14} - e^{23}). \quad (3.22)$$

So we can compute

$$\omega_+ \wedge \omega_+ = (a^2 + b^2)(d\alpha)^2 \quad \text{and} \quad \omega_- \wedge \omega_- = -(A^2 + B^2 + C^2)(d\alpha)^2. \quad (3.23)$$

Condition (3.15), recalling that $\omega_+ \wedge \omega_- = 0$, then reads

$$f(d\alpha)^2 = \omega_+ \wedge \omega_+ + \omega_- \wedge \omega_- = ((a^2 + b^2) - (A^2 + B^2 + C^2))(d\alpha)^2 \quad (3.24)$$

with a positive f , so $(a^2 + b^2) > (A^2 + B^2 + C^2)$. Observe that

$$\omega_-(e_i, J(e_i)) = \pm B \cos \theta \pm C \sin \theta,$$

with $\cos \theta = \frac{a}{\sqrt{a^2+b^2}}$, $\sin \theta = \frac{b}{\sqrt{a^2+b^2}}$. We can bound $|\pm B \cos \theta \pm C \sin \theta| \leq \sqrt{B^2 + C^2}$, so

$$\begin{aligned} \omega(e_i, J(e_i)) &= \omega_+(e_i, J(e_i)) + \omega_-(e_i, J(e_i)) = \sqrt{a^2 + b^2} + \omega_-(e_i, J(e_i)) \\ &\geq \sqrt{a^2 + b^2} - \sqrt{A^2 + B^2 + C^2} > 0. \end{aligned}$$

This means that the almost complex structure J is compatible with ω in the sense of (3.2) and they induce a metric $\tilde{g}(v, w) := \omega(v, Jw)$ for which J is orthogonal and ω is self dual and of norm $\sqrt{2}$. This gives a positive answer to the question raised in the beginning of this section.

Moreover we get

Proposition 3. *Given a contact 5-manifold (\mathcal{M}, α) , there exist almost complex structures J such that $d\alpha(v, Jv) = 0$ for all horizontal vectors v .*

Indeed, we can get a two-form ω satisfying (3.13) and (3.15). This can be done locally⁸ and then we can get a global form by using a partition of unity on \mathcal{M} . The previous discussion in this subsection then shows how to construct the requested almost complex structure from ω , thereby proving that anti-invariant almost complex structures exist.

Also remark that the almost complex structure J anti-compatible with $d\alpha$ that we constructed is orthogonal for the metric g associated to $d\alpha$ and I . Indeed, after having built the two-form ω satisfying (3.13) and (3.15), we defined J from its self-dual part (suitably rescaled) and from the metric g .

By changing the almost complex structure I compatible with $d\alpha$, we can get different anti-compatible structures.

We conclude with the following proposition, which gives a condition to ensure the applicability of theorem 3.0.2 to a semi-calibration.

Proposition 4. *Let (\mathcal{M}, α) be a contact 5-manifold, with a metric g defined⁹ by $g = d\alpha(\cdot, I\cdot)$ for an almost complex structure I compatible with $d\alpha$.*

Let ω be a two-form of comass 1, $\|\omega\|^ = 1$, such that:*

$$\omega \wedge d\alpha = 0, \quad \omega \wedge \omega = (d\alpha)^2.$$

Then ω is self-dual with respect to g . Moreover the almost complex structure $J := g^{-1}(\omega)$ is anti-compatible with $d\alpha$ and the (semi)-calibrated two-planes are exactly the J -invariant ones.

Therefore theorem 3.0.2 applies to such an ω , yielding the regularity of ω -(semi)calibrated cycles. The Special Legendrian semi-calibration treated in chapter 2 fulfils the requirements of Proposition 4.

proof of proposition 4. Decompose $\omega = \omega_+ + \omega_-$ as in (3.21) and (3.22). Evaluating ω on the unit simple 2-vector

$$\frac{1}{\sqrt{a^2 + b^2 + A^2}} e_1 \wedge (ae_3 + be_4 + Ae_2)$$

we get $\sqrt{a^2 + b^2 + A^2}$. The condition $\|\omega\|_* = 1$ implies $a^2 + b^2 + A^2 \leq 1$.

⁸For example, work on an open ball where we can apply Darboux's theorem (see [8] or [41]), which allows us to work with the standard contact structure of \mathbb{R}^5 described in the introduction (compare the explanation at the beginning of section 3.2.1).

⁹This is equivalent to asking that $d\alpha$ is self-dual and of norm $\sqrt{2}$ for g .

On the other hand, expliciting $\omega \wedge \omega = (d\alpha)^2$ as in (3.23), we obtain

$$a^2 + b^2 - A^2 - B^2 - C^2 = 1.$$

Hence $-B^2 - C^2 \geq 2A^2$, which trivially yields $A = B = C = 0$, so ω is a self-dual form.

A self-dual form of comass 1 expressed as in (3.21) must be of the form

$$\cos \theta(e^{13} + e^{42}) + \sin \theta(e^{14} + e^{23})$$

and the corresponding almost-complex structure $J = g^{-1}(\omega)$ has the expression (3.19) and is anti-compatible with $d\alpha$.

Take two orthonormal vectors v, w . Since $\omega(v, w) = \langle v, -Jw \rangle_g$, we have that

$$\omega(v, w) = 1 \Leftrightarrow w = Jv,$$

from which we can see that the semi-calibrated 2-planes are exactly those that are J -invariant for this J . □

3.1.3 From J to a two-form.

In this subsection, we want to answer the following question, in some sense the natural reverse to the one raised in the previous subsection.

Assume that, on a contact 5-manifold (\mathcal{M}, α) , an almost-complex structure J on the horizontal distribution H is given, which satisfies $d\alpha(Jv, v) = 0$ for any $v \in H$. Is there a two-form that is compatible with J in the sense of (3.2)?

Let I be an almost-complex structure compatible with the symplectic form $d\alpha$, and let g be the metric on \mathcal{M} defined by $g(v, w) := d\alpha(v, Iw) + \alpha \otimes \alpha$.

Define a two-form Ω by

$$\Omega(X, Y) := d\alpha(JX, \frac{1}{2}(JI - IJ)Y).$$

We can see that Ω is compatible with J as follows

$$\begin{aligned} \bullet \quad \Omega(JX, JY) &= \frac{1}{2}d\alpha(JX, JIJY + IY) = \\ &= -d\alpha(X, \frac{1}{2}IJY) + d\alpha(X, \frac{1}{2}JIY) = \Omega(X, Y), \\ \bullet \quad \Omega(X, JX) &= \frac{1}{2}d\alpha(X, JIJX + IX) = \\ &= \frac{1}{2}d\alpha(JX, IJX) + \frac{1}{2}d\alpha(X, IX) > 0, \end{aligned}$$

where we used the anti-compatibility property (3.9). It also follows that the metric $\tilde{g}(X, Y) := \Omega(X, JY) + \alpha \otimes \alpha$ is related to g by $\tilde{g}(X, Y) = \frac{1}{2}(g(X, Y) + g(JX, JY))$ when restricted to the horizontal sub-bundle.

In local coordinates, also just pointwise for a basis of the form $\{e_1 = X, e_2 = IX, e_3 = Y, e_4 = IY\}$ as in (3.17), it can be checked by a direct computation that Ω also satisfies $\Omega \wedge d\alpha = 0$.

The two-form Ω is a semi-calibration on the manifold \mathcal{M} endowed with the metric \tilde{g} . Indeed, since J preserves the \tilde{g} -norm, for any two vectors v, w at p which are orthonormal with respect to \tilde{g} it holds

$$\Omega(v, w) = \langle v, -Jw \rangle_{\tilde{g}} \leq |v|_{\tilde{g}} |Jw|_{\tilde{g}} = |v|_{\tilde{g}} |w|_{\tilde{g}} = 1,$$

and equality is realized if and only if $Jv = w$. This means that a 2-plane is Ω -calibrated if and only if it is J -invariant, so theorem 3.0.2 applies to Ω -semicalibrated cycles¹⁰.

If J is an orthogonal transformation with respect to g , the anti-compatibility with $d\alpha$ yields, for all horizontal vectors X, Y ,

$$\begin{cases} g(X, Y) = g(JX, JY) = \\ = d\alpha(JX, IJY) = d\alpha(X, JIJY) & \Rightarrow g(X, (Id + (IJ)^2)Y) = 0. \\ = d\alpha(IX, (IJ)^2Y) = -g(X, (IJ)^2Y) \end{cases}$$

Thus $(IJ)^2 = -Id$ when restricted to H , so $IJ = -JI$.

Hence $\Omega(X, Y) := d\alpha(X, JIY)$. In this case Ω is a self-dual form of norm $\sqrt{2}$ and comass $\|\Omega\|_* = 1$ with respect to g ¹¹.

3.2 Proof of theorem 3.0.2

3.2.1 Positive foliations

The regularity property in Theorem 3.0.2 is local. It is therefore enough to prove the statement for an arbitrarily small neighbourhood $B^5(p) \subset \mathcal{M}$ of any chosen $p \in \mathcal{M}$.

From Darboux's theorem, we know that there is a diffeomorphism¹² Φ from a ball centered at the origin of the standard contact manifold $(\mathbb{R}^5, dt -$

¹⁰We remark here that, being semi-calibrated, such a cycle will satisfy an almost-monotonicity formula at every point, as explained in [47].

¹¹Observe that, in this case, we have that pointwise $\{Id, I, J, IJ\}$ form a quaternionic structure.

¹²In the usual terminology, for example see [41] or [8], it is called a *contactomorphism* or *contact transformation*.

$y_1 dx^1 - y_2 dx^2$) to such a neighbourhood $B^5(p)$, with $\Phi^*(\alpha) = dt - (y_1 dx^1 + y_2 dx^2)$. The structure J on \mathcal{M} can be pulled-back to an almost complex structure on \mathbb{R}^5 via Φ :

$$(\Phi^* J)(X) := (\Phi^{-1})_*[J(\Phi_* X)] \quad \text{for } X \in \mathbb{R}^5.$$

Condition (3.8) yields

$$\begin{aligned} d(\Phi^* \alpha)((\Phi^* J)X, X) &= (\Phi^* d\alpha)((\Phi^{-1})_* J(\Phi_* X), X) = \\ &= d\alpha(J(\Phi_* X), \Phi_* X) = 0 \quad \text{for any } X \text{ horizontal vector in } \mathbb{R}^5. \end{aligned} \quad (3.25)$$

Therefore the induced almost complex structure $\Phi^* J$ is anti-compatible with the symplectic form $d(\Phi^* \alpha) = dx^1 dy^1 + dx^2 dy^2$.

It is now clear that we can afford to work in a ball centered at 0 of the standard contact structure (\mathbb{R}^5, ζ) with an almost complex structure J such that $d\zeta(v, Jv) = 0$.

In view of the construction of "positive foliations", we can start with the following question: given a point in \mathbb{R}^5 and a J -invariant plane through it, can we find an embedded Legendrian disk that is J -invariant and has the chosen plane as tangent?

The following is of fundamental importance:

Remark 3.2.1. Given a legendrian immersion of a 2-surface in \mathbb{R}^5 , any tangent plane D to it necessarily satisfies the condition $d\alpha(D) = 0$ (see [48]). (3.9) is therefore a necessary condition for the local existence of J -invariant disks through a point in any chosen direction.

On the other hand, always from [48], we know that every Lagrangian in \mathbb{R}^4 can be uniquely lifted to a Legendrian in \mathbb{R}^5 after having chosen a starting point in \mathbb{R}^5 .

In this subsection we will prove, in particular, the sufficiency of condition (3.9) for the local existence of a J -invariant Legendrian for which we assign its tangent at a chosen point.

With a slight abuse of notation, we can view $J(0)$ as an almost complex structure on \mathbb{R}^4 . With the notation in (3.7) and remark 3.0.3 in mind, we define the almost complex structure J_0 on the horizontal distribution of \mathbb{R}^5 by $J_0[(\pi^{-1})(V)] := (\pi^{-1})[J(0)(V)]$, for any vector V in \mathbb{R}^4 with arbitrary base-point.

By definition, J and J_0 agree at the origin. Let us analyse, in a first moment, the case $J = J_0$ everywhere. Due to the fact that J_0 is *projectable*

onto \mathbb{R}^4 things get simple and we can explicitly find an embedded Legendrian disk that is J_0 -invariant and with tangent at 0 the given D . This goes as follows: the plane D is $J(0)$ -invariant in \mathbb{R}^4 , and by the condition $d\alpha(D) = 0$ it is lagrangian for the symplectic form $d\alpha$. Therefore, by the result in [48], the plane can be lifted to a legendrian surface \tilde{D} in \mathbb{R}^5 passing through 0. This surface is then trivially J_0 -invariant, due to the fact that J_0 projects down to $J(0)$, and the tangent to \tilde{D} at 0 is D since $H_0 = \mathbb{R}^4$.

What about the case of a general J ? We want to use a fixed point argument in order to find a J -invariant Legendrian close to \tilde{D} . To achieve that, we need to ensure that we are working in a neighbourhood of the origin in \mathbb{R}^5 where $J - J_0$ is bounded in a suitable $C^{m,\nu}$ -norm.

Dilate \mathbb{R}^5 about the origin as follows:

$$\Lambda_r : (x_1, y_1, x_2, y_2, t) \rightarrow \left(\frac{x_1}{r}, \frac{y_1}{r}, \frac{x_2}{r}, \frac{y_2}{r}, \frac{t}{r} \right).$$

This dilation changes the contact structure: indeed, pulling-back the standard contact form by Λ_r^{-1} , we get

$$r^2 \left(\frac{1}{r} dt - (y_1 dx^1 + y_2 dx^2) \right);$$

thus the horizontal hyperplanes are

$$\text{Span}\{\partial_{x_1} + ry_1\partial_t, \partial_{x_2} + ry_2\partial_t, \partial_{y_1}, \partial_{y_2}\}.$$

The dilation has therefore the effect of "flattening" (with respect to the euclidean geometry) the horizontal distribution¹³.

We also pull back by Λ_r the almost complex structure J and for r small enough we can ensure that $\|\Lambda_r^* J - J_0\|_{C^{2,\nu}} = r \|J - J_0\|_{C^{2,\nu}(B_r)}$ is as small as we want.

Finding Legendrians in the dilated contact structure that are invariant for $\Lambda_r^* J$ is the same as finding J -invariant Legendrians in (\mathbb{R}^5, ζ) in a smaller ball around 0: we can go from the first to the second via Λ_r^{-1} . It is then enough to work in $(\mathbb{R}^5, (\Lambda_r^{-1})^* \zeta)$, with the almost complex structure $\Lambda_r^* J$.

By abuse of notation, we will drop the pull-backs and forget the factor r^2 ; our assumptions, to summarize, will be as follows:

$$\begin{aligned} \alpha &= \left(\frac{1}{r} dt - (y_1 dx^1 + y_2 dx^2) \right) \\ d\alpha &= dx^1 dy^1 + dx^2 dy^2 \\ \|J - J_0\|_{C^{2,\nu}(B_1)} &\leq \varepsilon \quad \text{for an arbitrarily small } \varepsilon. \end{aligned} \tag{3.26}$$

¹³The dilation $\left(\frac{x_1}{r}, \frac{y_1}{r}, \frac{x_2}{r}, \frac{y_2}{r}, \frac{t}{r^2} \right)$, on the other hand, would leave the horizontal distribution unchanged. This non-homogeneous transformation would still allow the proof of proposition 5, but in view of propositions 7 and 8 it is convenient to work with the "flattened" distribution.

Basic example. What can we say about an almost complex structure J on (\mathbb{R}^5, ζ) such that $d\zeta(v, Jv) = 0$ (and $d\zeta(v, w) = -d\zeta(Jv, Jw)$) for all horizontal vectors v and w ?

These conditions, applied to the vectors $\partial_{x_1} + y_1\partial_t, \partial_{x_2} + y_2\partial_t, \partial_{y_1}, \partial_{y_2}$, together with $J^2 = -Id$, give, after little computation, that J must have the following coordinate expression for some smooth functions $\sigma, \beta, \gamma, \delta$ of five coordinates¹⁴:

$$\begin{cases} J(\partial_{x_1} + y_1\partial_t) = \sigma(\partial_{x_1} + y_1\partial_t) + \beta(\partial_{x_2} + y_2\partial_t) + \gamma\partial_{y_2} \\ J(\partial_{x_2} + y_2\partial_t) = -\sigma(\partial_{x_2} + y_2\partial_t) + \delta(\partial_{x_1} + y_1\partial_t) - \gamma\partial_{y_1} \\ J(\partial_{y_1}) = \sigma\partial_{y_1} + \delta\partial_{y_2} + \frac{1+\sigma^2+\beta\delta}{\gamma}(\partial_{x_2} + y_2\partial_t) \\ J(\partial_{y_2}) = -\sigma\partial_{y_2} - \frac{1+\sigma^2+\beta\delta}{\gamma}(\partial_{x_1} + y_1\partial_t) + \beta\partial_{y_1}. \end{cases} \quad (3.27)$$

Local existence of J -invariant Legendrians. The results that we are going to prove, in particular the proofs of propositions 5, 7 and 8, follow the same guidelines as the proofs presented in the appendix of [50], with the due changes. In particular, equation (3.35) takes the place of equation (A.2) in [50]. In the 5-dimensional contact case that we are addressing, therefore, we will face a second order elliptic problem, in contrast to the 4-dimensional almost-complex case where the equation was of first order.

With remark 3.2.1 in mind, we will see that, in order to produce a solution of our problem, we will need to adapt coordinates to the chosen data, i.e. the point and the direction. Later on, with (3.48) and (3.52), we will understand the dependence on the data for the solutions obtained.

At that stage we will be able to produce the key tool for the proof of theorem 3.0.2: foliations made of 3-dimensional surfaces having the property of intersecting any J -invariant Legendrian in a positive way, see the discussion following proposition 8.

Proposition 5. *Let (\mathbb{R}^5, α) be the contact structure described in (3.26), with J an almost-complex structure defined on the horizontal distribution $H = \text{Ker } \alpha$ such that $d\alpha(Jv, v) = 0$ for any $v \in H$.*

Then, if ε is small enough¹⁵, for any J -invariant 2-plane D passing through 0, there exists locally an embedded Legendrian disk that is J -invariant and goes through 0 with tangent D .

Recalling the discussion at the beginning of this section, we can see that we are actually showing the following:

¹⁴We assume here that $\gamma \neq 0$. Remark that β and γ cannot both be 0, since $J^2 = -Id$.

¹⁵It will be clear after the proof that ε must be small compared to $\frac{1}{\|J_0\|N^2}$, where N is a constant depending on an elliptic operator defined from J_0 .

Proposition 6. *Let \mathcal{M} be a five-dimensional manifold endowed with a contact form α and let J be an almost-complex structure defined on the horizontal distribution $H = \text{Ker } \alpha$ such that $d\alpha(Jv, v) = 0$ for any $v \in H$.*

Then at any point $p \in \mathcal{M}$ and for any J -invariant 2-plane D in $T_p\mathcal{M}$, there exists an embedded Legendrian disk \mathcal{L} that is J -invariant and goes through p with tangent D .

proof of proposition 5. *Step 1.* Before going into the core of the proof, in the first two steps we perform a suitable change of coordinates.

The hyperplane H_0 coincides with $\mathbb{R}^4 = \{t = 0\}$. Up to an orthogonal change of coordinates in $H_0 = \mathbb{R}^4$ (the t -coordinate stays fixed), we can assume to have $D = \partial_{x_1} \wedge J(\partial_{x_1})$, with $d\alpha = dx^1 dy^1 + dx^2 dy^2$. This can be done as follows. If $D = v \wedge J(v)$, for a horizontal unit vector v at 0, choose an orthogonal coordinate system, still denoted by (x_1, y_1, x_2, y_2) , defined by $\{\partial_{x_1}, \partial_{y_1}, \partial_{x_2}, \partial_{y_2}\} := \{v, I(v), W, IW\}$, where I is the standard complex structure in (3.6) and W is a vector orthonormal to v and $J(v)$ for the metric g_ζ in (3.7).

There is freedom on the choice of W ; in step 2 we will determine it uniquely by imposing a further condition¹⁶. Before doing this we are going to make the notation less heavy.

This linear change of coordinates has not affected the fact that the hyperplanes $H_{\pi^{-1}(q)}$ are parallel¹⁷ in the standard coordinates of \mathbb{R}^5 . This means that, if we take a vector ∂_{x_i} [resp. ∂_{y_i}] in \mathbb{R}^4 , with base-point $q \in \mathbb{R}^4$, its lift to a horizontal vector based at any point of the fiber $\pi^{-1}(q)$ has a coordinate expression of the form $\partial_{x_i} + K^{x_i} \partial_t$ [resp. $\partial_{y_i} + K^{y_i} \partial_t$], where $K^{x_i} = K^{x_i}(x_1(q), x_2(q), y_1(q), y_2(q))$ and $K^{y_i} = K^{y_i}(x_1(q), x_2(q), y_1(q), y_2(q))$ are linear functions of the coordinates of q (they come from the last coordinate change).

We are interested in the expression for J in a neighbourhood of the origin. J acts on the horizontal vectors $\partial_{x_i} + K^{x_i} \partial_t$, $\partial_{y_i} + K^{y_i} \partial_t$. However, since the functions K^{x_i} , K^{y_i} are independent of t , by abuse of notation we will forget about the ∂_t -components of the horizontal lifts and speak of the action of J on $\partial_{x_i}, \partial_{y_i}$, keeping in mind that the coefficients of the linear map J are not constant along a fiber, i.e. J cannot be projected onto \mathbb{R}^4 .

With this in mind, recalling (3.27), the expression for J in the unit ball $B^1(0) \subset \mathbb{R}^5$ is as follows: there are smooth functions $\sigma, \beta, \gamma, \delta$ depending on the five coordinates of the chosen point, such that¹⁸

¹⁶This will be needed in view of *Step 4*.

¹⁷See remark 3.0.3.

¹⁸In (3.28) we are assuming that $\gamma \neq 0$. This is not restrictive. We can assume to be working in an open set where at least one of the functions β and γ is everywhere non-zero.

$$\left\{ \begin{array}{l} J(\partial_{x_1}) = \sigma\partial_{x_1} + \beta\partial_{x_2} + \gamma\partial_{y_2} \\ J(\partial_{x_2}) = -\sigma\partial_{x_2} + \delta\partial_{x_1} - \gamma\partial_{y_1} \\ J(\partial_{y_1}) = \sigma\partial_{y_1} + \delta\partial_{y_2} + \frac{1+\sigma^2+\beta\delta}{\gamma}\partial_{x_2} \\ J(\partial_{y_2}) = -\sigma\partial_{y_2} - \frac{1+\sigma^2+\beta\delta}{\gamma}\partial_{x_1} + \beta\partial_{y_1} \end{array} \right. \quad (3.28)$$

Step 2. Denote the values of these coefficients at 0 by $\delta(0) = \delta_0$, $\beta(0) = \beta_0$, $\sigma(0) = \sigma_0$, $\gamma(0) = \gamma_0$. We take now coordinates, that we underline to distinguish them from the old ones, determined by the transformation

$$\left\{ \begin{array}{l} \underline{\partial}_{x_1} = \partial_{x_1} \\ \underline{\partial}_{y_1} = \partial_{y_1} \\ \underline{\partial}_{x_2} = \frac{\gamma_0}{\sqrt{\beta_0^2 + \gamma_0^2}}\partial_{x_2} - \frac{\beta_0}{\sqrt{\beta_0^2 + \gamma_0^2}}\partial_{y_2} \\ \underline{\partial}_{y_2} = \frac{\beta_0}{\sqrt{\beta_0^2 + \gamma_0^2}}\partial_{x_2} + \frac{\gamma_0}{\sqrt{\beta_0^2 + \gamma_0^2}}\partial_{y_2} \\ \underline{\partial}_t = \partial_t \end{array} \right. \quad (3.29)$$

In the new coordinates, the endomorphism J at 0 acts on $\underline{\partial}_{x_1}$ as

$$J_0(\underline{\partial}_{x_1}) = \sigma_0\underline{\partial}_{x_1} + \sqrt{\beta_0^2 + \gamma_0^2}\underline{\partial}_{y_2}$$

and the symplectic form $d\alpha$ still has the standard expression.

From now on we will write these new coordinates again as (x_1, y_1, x_2, y_2, t) , without underlining them.

To summarize what we did in steps 1 and 2: we will now work in the unit ball of \mathbb{R}^5 with the symplectic form $d\alpha = dx^1dy^1 + dx^2dy^2$ on the horizontal distribution and an almost complex structure J such that $\|J - J_0\|_{C^{2,\nu}} < \varepsilon$ for some small ε that we will determine precisely later on, and such that J is expressed by (3.28) with smooth functions $\sigma, \beta, \gamma, \delta$ depending on the five coordinates and satisfying $\beta_0 = 0$, $\gamma_0 > 0$. The J -invariant plane D is given by $D = \partial_{x_1} \wedge J(\partial_{x_1})$.

The double coordinate change in steps 1 and 2 can be characterized as the unique change of coordinates such that $d\alpha = dx^1dy^1 + dx^2dy^2$ and $D = \partial_{x_1} \wedge J(\partial_{x_1}) = \gamma_0(\partial_{x_1} \wedge \partial_{y_2})$ (for a positive γ_0).

Step 3. We are looking for an embedded Legendrian disk with tangent D at the origin, therefore we will seek a Legendrian that is a graph over $D = \partial_{x_1} \wedge \partial_{y_2}$. Recall from [48] that the projection of any Legendrian immersion in \mathbb{R}^5 is a Lagrangian in \mathbb{R}^4 with respect to the symplectic form $d\alpha$. A

If this is the case for β and not for γ , a change of coordinates sending $\partial_{x_2} \rightarrow \partial_{y_2}$ and $\partial_{y_2} \rightarrow -\partial_{x_2}$ would lead us to (3.28) again.

Lagrangian graph over $D = \partial_{x_1} \wedge \partial_{y_2}$ must be of the form (see III.2 of [30], in particular lemma 2.2)

$$\left(x_1, \frac{\partial f(x_1, y_2)}{\partial x_1}, -\frac{\partial f(x_1, y_2)}{\partial y_2}, y_2 \right) \text{ for some } f : D_{x_1, y_2}^2 \rightarrow \mathbb{R}. \quad (3.30)$$

The minus in the x_2 -component is due to the fact that $I(\partial_{y_2}) = -\partial_{x_2}$, while $I(\partial_{x_1}) = \partial_{y_1}$. Our problem can be now restated as follows: find a function $f : D^2 \rightarrow \mathbb{R}$ such that the lift \mathcal{L} with starting point 0 of the Lagrangian disk

$$L(x_1, y_2) := \left(x_1, \frac{\partial f}{\partial x_1}, -\frac{\partial f}{\partial y_2}, y_2 \right)$$

is J -invariant¹⁹.

The J -invariance condition is a constraint on the tangent planes: it is expressed by the following equation for the lift \mathcal{L} of L :

$$J \left(\frac{\partial \mathcal{L}}{\partial x_1} \right) = (1 + \lambda) \frac{\partial \mathcal{L}}{\partial y_2} + \mu \frac{\partial \mathcal{L}}{\partial x_1}, \quad (3.31)$$

with λ and μ unknown, real-valued functions. However, thanks to what we observed in step 1, the tangent vectors $\frac{\partial \mathcal{L}}{\partial x_1}$ and $\frac{\partial \mathcal{L}}{\partial y_2}$ to the lift \mathcal{L} at any point have the first four components which equal $\frac{\partial L}{\partial x_1}$ and $\frac{\partial L}{\partial y_2}$ at the projection of the chosen point, independently of where we are lifting along the fiber; the fifth component of $\frac{\partial \mathcal{L}}{\partial x_1}$ and $\frac{\partial \mathcal{L}}{\partial y_2}$ is uniquely determined by the other four and by the point (x_1, y_1, x_2, y_2) in \mathbb{R}^4 . We will therefore consider equation (3.31) only for $\frac{\partial L}{\partial x_1}$ and $\frac{\partial L}{\partial y_2}$.

We denote the partial derivatives $\frac{\partial f(x_1, y_2)}{\partial x_1}$, $\frac{\partial f(x_1, y_2)}{\partial y_2}$, $\frac{\partial^2 f(x_1, y_2)}{\partial x_1^2}$, $\frac{\partial^2 f(x_1, y_2)}{\partial x_1 \partial y_2}$ and $\frac{\partial^2 f(x_1, y_2)}{\partial y_2^2}$ respectively by f_1 , f_2 , f_{11} , f_{12} and f_{22} . Then

$$L(x_1, y_2) = \begin{pmatrix} x_1 \\ f_1 \\ -f_2 \\ y_2 \end{pmatrix}, \quad \frac{\partial L}{\partial x_1} = \begin{pmatrix} 1 \\ f_{11} \\ -f_{12} \\ 0 \end{pmatrix}, \quad \frac{\partial L}{\partial y_2} = \begin{pmatrix} 0 \\ f_{12} \\ -f_{22} \\ 1 \end{pmatrix}. \quad (3.32)$$

It should be however born in mind that J does depend on where we are lifting! After little manipulation, making use of (3.28), the equation in (3.31) reads:

¹⁹By lift of L with starting point 0, we mean that the t -component of $\mathcal{L}(0, 0)$ is 0.

At this point we can see how, in the 5-dimensional contact case, the necessity of lifting naturally leads to a second-order equation. In the 4-dimensional almost-complex case, one does not need to worry about lifting.

$$\begin{pmatrix} \sigma - \delta f_{12} - \mu \\ \sigma f_{11} - (1 - \gamma)f_{12} - \lambda f_{12} - \mu f_{11} \\ \Delta f + \beta + \frac{1 + \sigma^2 + \beta\delta - \gamma}{\gamma} f_{11} + \sigma f_{12} + \lambda f_{22} + \mu f_{12} \\ \gamma - 1 + \delta f_{11} - \lambda \end{pmatrix} = \begin{pmatrix} 0 \\ 0 \\ 0 \\ 0 \end{pmatrix}, \quad (3.33)$$

with $\sigma, \beta, \gamma, \delta$ evaluated at the lift of $L = (x_1, f_1, -f_2, y_2)$ in \mathbb{R}^5 with starting point 0.

From the first and fourth line of (3.33) we get

$$\mu = -\delta f_{12} + \sigma, \quad \lambda = \gamma - 1 + \delta f_{11}. \quad (3.34)$$

The second line of (3.33) can be checked to hold automatically true with these values of μ and λ . Then we need to find f solving the third line of (3.33) with the μ and λ given in (3.34). We stress once again that (3.33) should be solved for f with $\sigma, \beta, \gamma, \delta$ depending on the lift of $(x_1, f_1, -f_2, y_2)$. Let us write the third line of (3.33) explicitly. It reads

$$\sum_{i,j=1}^2 M_{ij} f_{ij} = \delta(f_{12}^2 - f_{11}f_{22}) - \beta + \sum_{i,j=1}^2 A_{ij} f_{ij}, \quad (3.35)$$

where M and A are the matrices

$$M = \begin{pmatrix} \frac{1 + \sigma_0^2}{\gamma_0} & -\sigma_0 \\ -\sigma_0 & \gamma_0 \end{pmatrix}, \quad A = \begin{pmatrix} \frac{1 + \sigma^2 + \beta\delta}{\gamma} - \frac{1 + \sigma_0^2}{\gamma_0} & \sigma - \sigma_0 \\ \sigma - \sigma_0 & \gamma_0 - \gamma \end{pmatrix}. \quad (3.36)$$

M is a positive definite matrix and satisfies, for any vector $(\xi_1, \xi_2) \in \mathbb{R}^2$, the ellipticity condition

$$\sum_{i,j=1}^2 M_{ij} \xi_i \xi_j \geq k(\xi_1^2 + \xi_2^2) \text{ for a positive } k.$$

Remark also that, at the origin, $\beta(0) = 0$ and A is the zero matrix. The zero function $f = 0$, describes the disk D . We want to solve equation (3.35) by a fixed point method in order to find a solution f close to 0. We will write Mf for the elliptic operator on the left hand side of (3.35).

Consider the functional \mathcal{F} defined as follows: for $h \in C^{2,\nu}$ let $\mathcal{F}(h)$ be the solution of the following well-posed elliptic problem:

$$\begin{cases} M[\mathcal{F}(h)] = \delta_h(h_{12}^2 - h_{11}h_{22}) - \beta_h + A_{ij} h_{ij} \\ \mathcal{F}(h)|_{\partial D^2} = 0, \end{cases} \quad (3.37)$$

where by δ_h , β_h and A_{ijh} we mean respectively the functions δ , β and A_{ij} evaluated at the lift²⁰ of $(x_1, h_1, -h_2, y_2)$ in \mathbb{R}^5 and considered as functions of (x_1, y_2) . A fixed point of \mathcal{F} is a solution of (3.35). We know from elliptic regularity that $\mathcal{F}(h)$ belongs to the space $C^{2,\nu}$ and Schauder estimates give

$$\|\mathcal{F}(h)\|_{C^{2,\nu}} \leq N\|\delta_h(h_{12}^2 - h_{11}h_{22}) - \beta_h + A_{ijh}h_{ij}\|_{C^{0,\nu}} \quad (3.38)$$

for an universal constant N (depending on k). To make the notation simpler in the following, we will assume $N > 2$.

We are about to show the following claim: for $\|J - J_0\|_{C^{2,\nu}}$ small enough, the functional \mathcal{F} is a contraction from the closed ball

$$\left\{ h \in C^{2,\nu} : \|h\|_{C^{2,\nu}} \leq \frac{1}{48 \max\{1, |\delta_0|\}N} \right\} \quad (3.39)$$

into itself.

First of all, let us compute, for $h, g \in C^{2,\nu}$,

$$\begin{aligned} M[\mathcal{F}(h) - \mathcal{F}(g)] &= \delta_h(h_{12}^2 - g_{12}^2 + g_{11}g_{22} - h_{11}h_{22}) + \\ & (g_{12}^2 - g_{11}g_{22})(\delta_h - \delta_g) + (\beta_g - \beta_h) + A_{ijh}h_{ij} - A_{ijg}g_{ij} = \\ & = \delta_h[(h_{12} + g_{12})(h_{12} - g_{12}) + g_{11}(g_{22} - h_{22}) + h_{22}(g_{11} - h_{11})] + \\ & + (g_{12}^2 - g_{11}g_{22})(\delta_h - \delta_g) + (\beta_g - \beta_h) + A_{ijh}(h_{ij} - g_{ij}) + (A_{ijh} - A_{ijg})g_{ij}. \end{aligned} \quad (3.40)$$

Remark that we have bounds of the form

$$\begin{cases} \|\delta_h\|_{C^1} \leq \|\delta\|_{C^0} + 2\|\nabla\delta\|_{C^0}\|h\|_{C^2}, \\ \|\delta_h - \delta_g\|_{C^1} \leq 2(\|\delta\|_{C^2}\|h\|_{C^2} + 2\|\nabla\delta\|_{C^0})\|h - g\|_{C^2}, \end{cases} \quad (3.41)$$

where the norms are taken in the unit ball $B_1^5(0)$. Similar bounds hold true for β and A_{ij} .

For $\|J - J_0\|_{C^{2,\nu}}$ small enough, in particular if $\|\delta\|_{C^2} \leq 2|\delta_0|$, Schauder theory applied to equation (3.40) with boundary data $(\mathcal{F}(h) - \mathcal{F}(g))|_{\partial D^2} = 0$ gives

$$\begin{aligned} \|\mathcal{F}(h) - \mathcal{F}(g)\|_{C^{2,\nu}} &\leq \\ N(4|\delta_0|(\|h\|_{C^{2,\nu}} + \|g\|_{C^{2,\nu}}) + 4\|g\|_{C^{2,\nu}}^2 + 4\|\beta\|_{C^2} + 6\|A\|_{C^2})\|h - g\|_{C^{2,\nu}}. \end{aligned} \quad (3.42)$$

Let us now estimate, again by (3.38)

$$\|\mathcal{F}(h)\|_{C^{2,\nu}} \leq 4N|\delta_0|\|h\|_{C^{2,\nu}}^2 + 2N\|A\|_{C^1}\|h\|_{C^{2,\nu}} + \|\beta\|_{C^1}. \quad (3.43)$$

²⁰As always, we are lifting the point $(0, h_1(0,0), -h_2(0,0), 0) \in \mathbb{R}^4$ to the point $(0, h_1(0,0), -h_2(0,0), 0, 0) \in \mathbb{R}^5$. This determines the lift of $(x_1, h_1, -h_2, y_2)$ uniquely.

If $\|\beta\|_{C^2} + \|A\|_{C^2} \leq \frac{1}{24 \max\{1, |\delta_0|\} N^2}$, which surely holds for $\|J - J_0\|_{C^{2,\nu}}$ small enough, by (3.42) and (3.43) we get that \mathcal{F} is a contraction of the forementioned ball (3.39). By Banach-Caccioppoli's theorem, there exists a unique fixed point f of \mathcal{F} , so we get a solution to equation (3.35) of small $C^{2,\nu}$ -norm.

More precisely, from (3.43) we get

$$\|f\|_{C^{2,\nu}} \leq K(\varepsilon), \quad (3.44)$$

where $K(\varepsilon)$ is a constant that goes to zero as $\varepsilon \rightarrow 0$.

The lift of $(x_1, f_1, -f_2, y_2)$ is an embedded, J -invariant, Legendrian disk that we denote $\mathcal{L}_{0,D}$. This disk, however, does not necessarily pass through the origin.

Step 4. In step 3 we constructed a J -invariant disk that is a small $C^{2,\nu}$ -perturbation of D but that might not pass through 0.

We need to generalize the construction performed in step 3. Let us set up notations: we are working in the unit ball of \mathbb{R}^5 , with coordinates (x_1, y_1, x_2, y_2, t) , such that the point p in the statement of Proposition 5 is the origin 0 and D is the plane $\partial_{x_1} \wedge J_P(\partial_{x_1})$ at the origin. The almost complex structure J satisfies $\|J - J_0\|_{C^{2,\nu}} < \varepsilon$ for some positive ε as small as we want. An upper bound for ε was described in step 3.

Denote by $Z_r := \{(0, y_1, x_2, 0, t) : x_2^2 + y_1^2 \leq r^2, |t| \leq r\}$. For any point $P \in B_1(0) \subset \mathbb{R}^5$, the set of J -invariant planes at P can be parametrized by $\mathbb{C}\mathbb{P}^1$: we will use the following identification between H_P and \mathbb{C}^2

$$\partial_{x_1} = (0, 1), \quad J_P(\partial_{x_1}) = (0, i), \quad \partial_{y_1} = (1, 0), \quad J_P(\partial_{y_1}) = (i, 0). \quad (3.45)$$

Passing to the quotient, we get a pointwise identification η_P between $\{\Pi : \Pi \text{ is a } J\text{-invariant 2-plane in } H_P\}$ and $\mathbb{C}\mathbb{P}^1$. In this identification, for any point P the planes $\partial_{x_1} \wedge J_P(\partial_{x_1})$ are represented by $[0, 1] \in \mathbb{C}\mathbb{P}^1$.

We denote by \mathcal{U}_r^P the set of J -invariant planes at P which are identified via η_P with $\mathcal{U}_r := \{[W_1, W_2] \in \mathbb{C}\mathbb{P}^1 : |W_1| \leq r|W_2|\}$. This allows us to regard the set

$$\{(P, X) \text{ with } P \in Z_r \text{ and } X \in \mathcal{U}_r^P\}$$

as the product manifold

$$Z_r \times \mathcal{U}_r.$$

For any couple $(P, X) \in Z_1 \times \mathcal{U}_1$, we can set coordinates adapted to (P, X) as follows: after a translation sending 0 to P , we can rotate the coordinate

axis by choosing v_X , the orthogonal projection of ∂_{x_1} onto the closed, 2-dimensional, unit ball in X and setting the new ∂_{x_1} to be $\frac{v_X}{|v_X|}$. With this choice, we can perform the same change of coordinate²¹ that we had in steps 1,2 and 3.

Now, using a fixed point argument as in step 3, we can associate to any couple $(P, X) \in Z_1 \times \mathcal{U}_1$ a J -invariant disk that we denote by $\mathcal{L}_{P,X}$.

The estimate given by (3.44) implies that $|T\mathcal{L}_{P,X} - X| \leq K(\varepsilon)$, so in particular we have $T\mathcal{L}_{P,X} \in \mathcal{U}_{1+K(\varepsilon)}$.

Hence $\mathcal{L}_{P,X}$ is transversal to the 3-dimensional plane $\{(0, y_1, x_2, 0, t)\}$. Consider the point $Q := \mathcal{L}_{P,X} \cap \{(0, y_1, x_2, 0, t)\}$ and the tangent plane to $\mathcal{L}_{P,X}$ at Q . We get a map

$$\Psi : Z_1 \times \mathcal{U}_1 \rightarrow Z_{1+K(\varepsilon)} \times \mathcal{U}_{1+K(\varepsilon)}$$

$$\Psi(P, X) = (Q, T_Q\mathcal{L}_{P,X}).$$

Condition (3.44) tells us that

$$\|\Psi - Id\|_{C^{2,\nu}} \leq K(\varepsilon), \quad (3.46)$$

where $K(\varepsilon) \rightarrow 0$ as $\varepsilon \rightarrow 0$. Therefore Ψ is invertible on an open set \mathcal{U}_r , and \mathcal{U}_r is ε -close to \mathcal{U}_1 . So, for $\|J - J_0\|_{C^{2,\nu}} \leq \varepsilon$ small enough, by inverting Ψ we get that for every point Q in Z_r and any J -invariant disk Y through Q lying in \mathcal{U}_r^q , we can find a couple $(P, X) \in Z_1 \times \mathcal{U}_1$ such that $\mathcal{L}_{P,X}$ goes through Q with tangent Y .

In particular we can find an embedded, J -invariant Legendrian disk which goes through 0 with tangent $\partial_{x_1} \wedge J\partial_{x_1}$.

Remark that, due to the smoothness of J , the same proof performed using the space $C^{m,\nu}$ for any $m \geq 2$ rather than $C^{2,\nu}$ gives that the disks $\mathcal{L}_{P,X}$ are in fact C^∞ -smooth.

We have thus proved Proposition 5. □

Remark again that we have actually shown more: in the coordinates described in (3.45), for each couple (p, X) , $p \in Z_1$, $X \in \mathcal{U}_1 \subset \mathbb{C}\mathbb{P}^1$ we can find²² an embedded, J -invariant Legendrian disk which goes through p with tangent X .

This will be useful for the next results.

²¹In the sequel we will denote by $\mathbb{E}_{P,X}$ the affine map which induces this change of coordinates.

²²The above proof actually yielded the result for an open set \mathcal{U}_r with r close to 1, but of course we can assume that it holds for $r = 1$.

Dependence on the choice of coordinates. In the previous proof we constructed, from each couple (p, X) , $p \in Z_1$, $X \in \mathcal{U}_1 \subset \mathbb{CP}^1$, a disk $\mathcal{L}_{p,X}$ whose projection $L_{p,X}$ in \mathbb{R}^4 is described, in suitable coordinates for which $X = \partial_{x_1} \wedge \partial_{y_2}$, as a graph $(x_1, f_1, -f_2, y_2)$. To make notations adapted to what we want to develop in this section, we will write $f^{p,X}$ instead of f for the function whose gradient describes the graph.

Given (p, X) , in *step 4* we chose uniquely the change of coordinates to perform in order to write the equations that lead to the solution $f^{p,X}$ of (3.35). We denote the affine map that induces the change of coordinates by $\mathbb{E}_{p,X}$. The function $f^{p,X}(x_1, y_2)$ solves equation (3.35) with coefficients $\delta, \beta, \sigma, \gamma$ depending on $\mathbb{E}_{p,X}$, therefore we will now write it as

$$M_{ij}^{p,X} f_{ij}^{p,X} = \delta^{p,X} ((f^{p,X})_{12}^2 - (f^{p,X})_{11}(f^{p,X})_{22}) - \beta^{p,X} + \sum_{i,j=1}^2 A_{ij}^{p,X} (f^{p,X})_{ij}, \quad (3.47)$$

where $M^{p,X}$ and $A^{p,X}$ are as in (3.36) but we explicitated the (p, X) -dependence. All the functions in (3.47) are functions of (x_1, y_2) , but we want to see how the solution $f^{p,X}(x_1, y_2)$ changes with (p, X) . In this section we will denote by ∇_X and ∇_p the gradients with respect to the variables $X \in \mathcal{U}_1$ and $p \in Z_1$. The x_1 and y_2 derivatives will still be denoted by pedices $i, j \in \{1, 2\}$.

Lemma 3.2.1. *As $X \in \mathcal{U}_1$ and $p \in Z_1 \subset \mathbb{R}^5$, the solutions $f^{p,X}$ of the corresponding equations (3.47) satisfy*

$$\text{for } s, l \in \{0, 1, 2\}, \quad \|\nabla_p^s \nabla_X^l f^{p,X}\|_{C^{2,\nu}} \leq K(\varepsilon), \quad (3.48)$$

where $K(\varepsilon)$ is a constant that goes to 0 as $\varepsilon \rightarrow 0$ (so we can make $K(\varepsilon)$ as small as we want by dilating enough).

Proof. Differentiating (3.47) w.r.t. X we get:

$$\begin{aligned} M_{ij}^{p,X} (\nabla_X f^{p,X})_{ij} &= (\nabla_X \delta^{p,X}) ((f^{p,X})_{12}^2 - (f^{p,X})_{11}(f^{p,X})_{22}) + \\ &+ \delta^{p,X} (2(f^{p,X})_{12}(\nabla_X f^{p,X})_{12} - (f^{p,X})_{11}(\nabla_X f^{p,X})_{22} - (f^{p,X})_{22}(\nabla_X f^{p,X})_{11}) - \\ &- \nabla_X \beta^{p,X} + (\nabla_X A_{ij}^{p,X}) (f^{p,X})_{ij} + A_{ij}^{p,X} (\nabla_X f^{p,X})_{ij} - (\nabla_X M^{p,X})_{ij} (f^{p,X})_{ij}. \end{aligned}$$

The quantities $\nabla_X \delta^{p,X}$, $\nabla_X M^{p,X}$, etc, are all bounded in $C^{2,\nu}$ -norm by some constant K (uniform in p and X) which depends on $\|J\|_{C^{2,\nu}}$ and $\|\mathbb{E}\|_{C^{2,\nu}}$.

Recalling that $\|f^{p,X}\|_{C^{2,\nu}} \leq K(\varepsilon)$, by elliptic theory we get that $\nabla_X f^{p,X}$ satisfies

$$\|\nabla_X f^{p,X}\|_{C^{2,\nu}} \leq K(\varepsilon) + \|\nabla_X \beta^{p,X}\|_{C^{0,\nu}}.$$

$\mathbb{E}_{p,X}$ was chosen so that the function $\beta^{p,X}(x_1, y_2)$ satisfies $\beta^{p,X}(0, 0) = 0$ for all (p, X) . Therefore

$$\text{for } s, l \in \{0, 1, 2\} \quad \nabla_p^s \nabla_X^l \beta^{p,X} = 0 \text{ when evaluated at } (x_1, y_2) = (0, 0).$$

Then it is not difficult to see that

$$\text{for } s, l \in \{0, 1, 2\}, \quad \|\nabla_p^s \nabla_X^l \beta^{p,X}\|_{C^1} \leq K(\varepsilon) \text{ for } (x_1, y_2) \in D^2.$$

Therefore

$$\|\nabla_X f^{p,X}\|_{C^{2,\nu}} \leq K(\varepsilon).$$

In an analogous fashion we can get estimates of the form

$$\text{for } s, l \in \{0, 1, 2\}, \quad \|\nabla_p^s \nabla_X^l f^{p,X}\|_{C^{2,\nu}} \leq K(\varepsilon).$$

□

Legendrians as graphs on the same disk. For each couple $(p, X) \in Z_1 \times \mathcal{U}_1$, we have that the embedded disk $\mathcal{L}_{\Psi^{-1}(p,X)}$ passes through p with tangent X .

So far, each $f^{p,X}$ was produced in the system of coordinates induced by $\mathbb{E}_{p,X}$, so $L_{p,X}$ was seen as a graph on X . However, thanks to (3.44), $L_{p,X}$ is also a $C^{2,\nu}$ -graph over $[0, 1]$ for any $X \in \mathcal{U}_1$. We will now look at all $X \in \mathcal{U}_1$ and at all $L_{p,X}$ as graphs on $[0, 1]$. In particular we will concentrate on the planes X through points $(0, t) \in \mathbb{R}^4 \times \mathbb{R}$ and on $\mathcal{L}_{\Psi^{-1}((0,t),X)}$, the J -invariant Legendrian which goes through $(0, t)$ with tangent X .

Any $X \in \mathcal{U}_1^{(0,t)}$, which is a J -invariant 2-plane through $(0, t)$, is described as the graph over $\partial_{x_1} \wedge \partial_{y_2} \cong [0, 1]$ of an affine \mathbb{R}^2 -valued function

$$H^X : (x_1, y_2) \rightarrow (h_1^X, -h_2^X).$$

If $t = 0$, we can use complex notation, identifying $H_0 = \mathbb{R}^4$ with \mathbb{C}^2 as in (3.45), so

$$\partial_{x_1} = (0, 1), \quad J_0(\partial_{x_1}) = (0, i), \quad \partial_{y_1} = (1, 0), \quad J_0(\partial_{y_1}) = (i, 0). \quad (3.49)$$

Then, if $X = [W_1, W_2]$, we have that H^X can be expressed as

$$H^X : z \rightarrow \zeta = \frac{W_1}{W_2} z.$$

Otherwise, if $t \neq 0$, H^X is just an affine function since $J_{(0,t)} \neq J_0$ in general.

What about $L_{\Psi^{-1}((0,t),X)}$, the projection of $\mathcal{L}_{\Psi^{-1}((0,t),X)}$ onto \mathbb{R}^4 ? It was described as the graph of the function “gradient of $f^{\Psi^{-1}((0,t),X)}$ ” over the unit disk in the 2-plane given by the second component of $\Psi^{-1}((0,t),X)$.

Of course, if we want to write it as a graph on $\partial_{x_1} \wedge \partial_{y_2}$, we will only be able to do so on a restricted disk, for example $\{(x_1, y_2) : |x_1^2 + y_2^2| \leq \frac{1}{2}\}$. To simplify the exposition, however, we will assume that $f^{\Psi^{-1}((0,t),X)}$ was defined on a larger disk D_X inside X so that, for any $X \in \mathcal{U}_1$, $L_{\Psi^{-1}((0,t),X)}$ can be written as a graph on the unit disk $\{(x_1, y_2) : |x_1^2 + y_2^2| \leq 1\}$ in the $\partial_{x_1} \wedge \partial_{y_2}$ -plane.

We will denote by D_0 the 2-dimensional unit disk, and we will identify it with $\{(x_1, y_2) : |x_1^2 + y_2^2| \leq 1\}$ in the $\partial_{x_1} \wedge \partial_{y_2}$ -plane.

It is not difficult to see that, for each choice of t and X , there are a diffeomorphism d from D_0 to the enlarged disk D_X and an affine transformation \mathbb{T} of \mathbb{R}^2 depending on X , t and $\Psi^{-1}((0,t),X)$ such that, over D_0 , $L_{\Psi^{-1}((0,t),X)}$ is the graph of a function of the form

$$H^{t,X} + F^{t,X} : D_0 \rightarrow \mathbb{R}^2, \text{ with } F^{t,X} := \mathbb{T} \circ \nabla f^{\Psi^{-1}((0,t),X)} \circ d. \quad (3.50)$$

Both d and \mathbb{T} , due to the estimate (3.46), have bounded derivatives

$$n, s, l \in \{0, 1, 2\}, \quad \|\nabla_z^n \nabla_p^s \nabla_X^l \mathbb{T}\|_{L^\infty} + \|\nabla_z^n \nabla_p^s \nabla_X^l d\|_{L^\infty} \leq K < \infty, \quad (3.51)$$

uniformly in $X \in \mathcal{U}_1$, $p \in Z_1$ and $z \in D_0$.

For $X \in \mathcal{U}_1$, from the definition (3.50), using (3.51), (3.48) and (3.46), we get, for $n, s, l \in \{0, 1, 2\}$,

$$\|\nabla_z^n \nabla_p^s \nabla_X^l F^{t,X}\|_{L^\infty} \leq K \|\nabla_z^n \nabla_p^s \nabla_X^l f^{\Psi^{-1}((0,t),X)}\|_{L^\infty} \leq K(\varepsilon), \quad (3.52)$$

with $K(\varepsilon) \rightarrow 0$ as $\varepsilon \rightarrow 0$.

Construction of the 3-dimensional surfaces: polar foliation. Using coordinates as in (3.49), so that the hyperplane H_0 is identified with \mathbb{C}^2 , we expressed each $L_{\Psi^{-1}((0,t),X)}$ as the graph of the following function

$$H^{t,X} + F^{t,X} : D_0 \rightarrow \mathbb{R}^2 = \mathbb{C},$$

which is a perturbation of the affine function $H^{t,X}$ representing the projection on \mathbb{R}^4 of the disk X through $(0, t)$.

For the construction that we are about to make, we need to fix a smooth determination of vectors $V_X \in X$ for $X \in \mathcal{U}_1$. There are many ways to do so, we will do it as follows. In our coordinates $\partial_{x_1} \in [0, 1]$. Then, in the unit disk

centered at 0 inside X , chose the vector v_X that minimizes²³ the distance to ∂_{x_1} and take $V_X = \frac{v_X}{|v_X|}$.

For any $t \in (-1, 1)$, and for each $X \in \mathcal{U}_1$, at the point $(0, t) \in \mathbb{R}^5$ (here $0 \in \mathbb{R}^4$), take the 2-plane given by $X^t := V_X \wedge J_{(0,t)}(V_X)$. In this notation, $X = X^0$. For each X and t , consider the Legendrian $\mathcal{L}_{\Psi^{-1}((0,t), X^t)}$ going through the point $(0, t)$ with tangent X^t : we will now denote it by $\tilde{\mathcal{L}}_{t, X^t}$. As $t \in (-1, 1)$, the union

$$\Sigma_0^X := \cup_{t \in (-1, 1)} \tilde{\mathcal{L}}_{t, X^t} \quad (3.53)$$

gives rise to a 3-dimensional smooth surface, as can be seen by writing the parametrization of Σ_0^X on $D_0 \times (-1, 1)$ and using (3.52)²⁴.

Each $\tilde{\mathcal{L}}_{t, X^t}$ has a projection \tilde{L}_{0, X^t} onto \mathbb{R}^4 which has a representation as the graph on D_0 of the function

$$H^{X^t} + F^{X^t} : D_0 \rightarrow \mathbb{R}^2 = \mathbb{C}.$$

From \tilde{L}_{0, X^t} , the surface $\tilde{\mathcal{L}}_{t, X^t}$ is uniquely recovered by lifting with starting point $(0, t)$.

Now with a little more effort we can show:

Proposition 7. *For $X \in \mathcal{U}_1$, the 3-surfaces Σ_0^X foliate the set $\{(\zeta, z, t) : |\zeta| \leq |z| \leq 1, |t| \leq \frac{1}{2}\} \subset \mathbb{C} \times \mathbb{C} \times \mathbb{R} = \mathbb{R}^5$.*

Remark 3.2.2. Following the terminology used in chapter 2, we can restate this proposition by saying that there exist locally *polar* foliations made of 3-surfaces built from embedded, Legendrian, J -invariant disks.

Proof. Choose any point $q = (\zeta_q, z_q, t_q) \in B^5 \subset \mathbb{R}^5 = \mathbb{C} \times \mathbb{C} \times \mathbb{R}$ which lies inside the set $\{|\zeta| \leq |z| \leq 1, |t| \leq \frac{1}{2}\}$. We need to show the existence and uniqueness of $X \in \mathcal{U}_1$ such that $q \in \Sigma_0^X$.

For $X \in \mathcal{U}_1$, denote by $Q = Q(q, X)$ the intersection point

$$Q = Q(q, X) := \Sigma_0^X \cap \{(\zeta, z, t) : z = z_q, t = t_q\}. \quad (3.54)$$

This is well-defined because $|T\Sigma_0^X - X| \leq K(\varepsilon)$ and the 3-plane spanned by X and ∂_t is transversal to the 2-plane $\{(\zeta, z, t) : z = z_q, t = t_q\}$ and they have a unique intersection point. By intersection theory, for ε small enough, Q is well defined for all $X \in \mathcal{U}_1$.

²³There is no geometric meaning in this particular choice, we are just suggesting a smooth determination of vectors, any choice would work the same.

²⁴Actually, from (3.52) we get that Σ_0^X is C^2 -smooth. However, (3.48) and (3.52) can be proved in the same way for higher-order derivatives, so we can get that Σ_0^X are as smooth as we want.

Consider the map

$$\begin{aligned} \chi_q : \mathcal{U}_1 &\rightarrow \mathbb{CP}^1 \\ X &\rightarrow [\zeta_Q, z_q] \end{aligned} \quad (3.55)$$

Due to the structure of Σ_0^X , the intersection Q is actually realized, for a certain t , as

$$Q = \tilde{\mathcal{L}}_{0, X^t} \cap \{(\zeta, z, t) : z = z_q, t = t_q\} \quad (3.56)$$

and we can also write

$$\chi_q(X) = [(H^{X^t} + F^{X^t})(z_q), z_q] \quad (3.57)$$

for the right t .

We will now prove that χ_q is a C^1 -perturbation of the identity map, which is nothing else but

$$\begin{aligned} Id : \mathcal{U}_1 &\rightarrow \mathcal{U}_1 \\ X &\rightarrow [H^X(z_q), z_q]. \end{aligned} \quad (3.58)$$

More precisely, we will prove that, independently of q ,

$$\|\nabla(\chi_q - Id)\|_{L^\infty} \leq K(\varepsilon), \quad (3.59)$$

for a constant $K(\varepsilon)$ that is an infinitesimal of ε .

We can use the chart $X = [W_1, W_2] = \frac{W_1}{W_2}$ on $\mathcal{U}_1 \subset \mathbb{CP}^1$. Then we must estimate

$$\begin{aligned} \|\nabla(\chi_q - Id)\|_{L^\infty} &= \left\| \nabla_X \left(\frac{(H^{X^t} + F^{X^t})(z_q)}{z_q} - \frac{H^X(z_q)}{z_q} \right) \right\|_{L^\infty} \\ &\leq \left\| \nabla_z \nabla_X (H^{X^t} - H^X + F^{X^t}) \right\|_{L^\infty} \leq \\ &\left\| \nabla_z \nabla_X (H^{X^t} - H^X) \right\|_{L^\infty} + \left\| \nabla_z \nabla_X F^{X^t} \right\|_{L^\infty} \leq K(\varepsilon), \end{aligned}$$

thanks to (3.52).

Thus χ_q is a diffeomorphism from \mathcal{U}_1 to an open subset of \mathbb{CP}^1 that tends to \mathcal{U} as $\varepsilon \rightarrow 0$. This means that we can invert χ_q and, for any chosen q we can find $X_q := (\chi_q)^{-1}([\zeta_q, z_q])$ such that $q \in \Sigma_0^{X_q}$. \square

Construction of the 3-dimensional surfaces: parallel foliation.

We are always using coordinates as in (3.49), so that H_0 is identified with \mathbb{C}^2 .

Choose a J -invariant plane $X \in \mathcal{U}_1$ passing through 0. We are going to produce a family of "parallel" 3-dimensional surfaces which foliate a neighbourhood of 0, where parallel means the following: each 3-surface has tangent planes which are everywhere ε -close to $X \wedge \partial_t$ in $C^{2,\nu}$ -norm.

This can be done in several ways, we choose the following. Take the vector v in the unit ball inside X which minimizes the distance to ∂_{x_1} , and set $V = \frac{v}{|v|}$. Parallel transport (in the euclidean sense²⁵) the vector V to each point P in the 2-plane $\{z = 0, t = 0\}$ and consider the family of J -invariant planes

$$\{X_P\} := \{V \wedge J_P(V)\}_{P \in \{z=0, t=0\}}.$$

Now, for each P , consider the line of points that project to P via $\pi : \mathbb{R}^5 \rightarrow \mathbb{R}^4$, and denote them by (P, t) . Take the Legendrian, J -invariant 2-surface going through the point (P, t) with tangent $X_P^t = V \wedge J_{(P,t)}(V)$: we will denote it by $\tilde{\mathcal{L}}_{P,t,X}$. Define the 3-dimensional surface

$$\Sigma_P^X := \cup_{t \in (-1,1)} \tilde{\mathcal{L}}_{P,t,X}. \quad (3.60)$$

As in (3.53), this is a smooth 3-surface.

Proposition 8. *For a fixed $X \in \mathcal{U}_1$, the 3-surfaces*

$$\{\Sigma_P^X\}_{P \in \{z=0, t=0, |\zeta| \leq 1\}}$$

foliate the set $\{(\zeta, z, t) : |\zeta| \leq 1, |z| \leq 1, |t| \leq \frac{1}{2}\} \subset \mathbb{C} \times \mathbb{C} \times \mathbb{R} = \mathbb{R}^5$.

Remark 3.2.3. Again, using the terminology of chapter 2, we are showing that there exist (locally) families of *parallel* foliations made of 3-surfaces built from embedded, Legendrian, J -invariant disks. Each family is determined by a "direction" X at 0.

Proof. Take any $q = (\zeta_q, z_q, t_q) \in B^5 \subset \mathbb{R}^5 = \mathbb{C} \times \mathbb{C} \times \mathbb{R}$. Denote by $Q = Q(q, X)$ the intersection point

$$Q = Q(q, P) := \Sigma_P^X \cap \{(\zeta, z, t) : z = z_q, t = t_q\}. \quad (3.61)$$

This is well-defined because $|T\Sigma_P^X - X| \leq K(\varepsilon)$ and the 3-plane spanned by X and ∂_t is transversal to the 2-plane $\{(\zeta, z, t) : z = z_q, t = t_q\}$ and they have a unique intersection point. By intersection theory, for ε small enough, Q is uniquely well-defined for all $P \in \{z = 0, t = 0\}$.

²⁵Again, this is just a possible way of doing it: there is no direct geometric meaning.

Consider the map

$$\begin{aligned} \Gamma_q : D_1^2 \subset \{z = 0, t = 0\} &\rightarrow \mathbb{R}^2 \cong \{(\zeta, z, t) : z = z_q, t = t_q\} \\ P &\rightarrow Q = Q(q, P) \end{aligned} \quad (3.62)$$

With an argument very similar to the one in proposition 7, we can prove that Γ_q is a C^1 -perturbation of the identity map and therefore the family

$$\{\Sigma_P^X\}_{P \in \{z=0, t=0, |\zeta| \leq 1\}} \quad (3.63)$$

foliates $\{|\zeta| \leq 1, |z| \leq 1, |t| \leq \frac{1}{2}\}$. □

Remark, from the construction of these 3-surfaces Σ , that each of them is made by attaching J -invariant Legendrian disks along a fiber of the contact structure. This fact yields the following fundamental

positive intersection property: each Σ constructed above has the property of intersecting positively any transversal J -invariant Legendrian.

The proof is just analogous to the corresponding corollary 2.1.1 of chapter 2. The key point is that two transversal J -invariant 2-planes in a hyperplane H_p intersect themselves positively with respect to the orientation inherited by H_p . The 3-surfaces Σ are smooth perturbations of a 3-plane of the form $X \wedge \partial_t$ for a J -invariant 2-plane X , so the result follows by continuity.

At this stage we have all the ingredients to show theorem 3.0.2 by following the proof of sections 2.2, 2.3, 2.4 and 2.5. For the convenience of the reader, here follows a brief overview of the forementioned proof with references to the corresponding sections.

3.2.2 Structure of the proof

A standard blow-up procedure, combined with the almost-monotonicity formula for semi-calibrated cycles²⁶, yields that C has a “stratified” structure: the multiplicity is well-defined and integer-valued at every point and, for

²⁶Recall that in section 3.1.3 we remarked that J -invariant 2-planes are just the semi-calibrated ones for a suitable 2-form Ω , therefore an almost-monotonicity formula (see [47] and the appendix to this thesis) holds with respect to the metric induced by J and Ω . Precisely, for any point x_0 , denoting by B_r the geodesic ball of radius r , we have that $\frac{M(C \llcorner B_r(x_0))}{r^2} = R(r) + O(r)$ for a function R which is monotonically non-increasing as $r \downarrow 0$ and tends to the multiplicity at x_0 as $r \downarrow 0$, and a function $O(r)$ which is infinitesimal.

$Q \in \mathbb{N}$, the set \mathcal{C}^Q of points having multiplicity $\leq Q$ is open in \mathcal{M} . This allows a localization of the problem by restricting to \mathcal{C}^Q and we can prove the final result by induction on the multiplicity for increasing integers Q .

A first outcome of the existence of foliations with the positive intersection property, is a self-contained proof of the uniqueness of tangent cones (section 2.3). This result was proved for general semi-calibrated cycles in [47] and for area-minimizing ones in [62], using different techniques.

Next, still exploiting the algebraic property of positive intersection, we can locally describe our current C as a multi-valued graph from a two-dimensional disk into \mathbb{R}^3 (section 2.4). The inductive step is divided into two parts: in the first we show that singularities of order Q cannot accumulate onto a singularity of the same multiplicity (section 2.4.5). In the second part, we prove that singularities of multiplicity $\leq Q - 1$ cannot accumulate on a singularity of order Q (section 2.5).

In the first part of the inductive step, we translate the J -invariance condition into a system of first-order PDEs for the multi-valued graph. These equations are “perturbations” of the classical Cauchy-Riemann equations, although in this case we have two real variables and three functions. We prove a $W^{1,2}$ -estimate on the average of the branches of the multi-valued graph (theorem 2.4.2). Then we complete the proof of the first part of the inductive step by suitably adapting the unique continuation argument used in [58].

For the second part of the inductive step (section 2.5) we use a homological argument. On a space modelled on $C \times \mathbb{R}$, we produce a S^2 -valued function u which allows to “count” the lower-multiplicity singularities by looking at its degree on the level sets of $|u|$ (lemma 2.5.4). A lower bound for the degree (lemma 2.5.5) then yields the result. This argument is inspired to the one used in [58], however the fifth coordinate induces a more involved and rather lengthy argument.

3.3 Final remarks

Examples. Let us illustrate some examples where the regularity result of theorem 3.0.2 applies.

- Let \mathcal{Y} be a Calabi-Yau 3-fold and denote by Θ the so-called *holomorphic volume form* and by β the symplectic form. Any²⁷ hypersurface $M^5 \subset \mathcal{Y}$ of

²⁷A Calabi-Yau 3-fold has *real* dimension 6. By hypersurface we mean here that the *real* codimension is 1.

contact type inherits a contact structure from the symplectic structure of \mathcal{Y} (see [41]), namely the structure associated to the one-form $\alpha = \iota_N \beta$, where N denotes a unit Liouville vector field and ι denotes the interior product. The form $Re(\iota_N \Theta)$ fulfils the requirements of proposition 4.

A typical situation is the following: let $\mathcal{Y} = \mathbb{C}^3$, with the standard complex structure I , and $\Theta = dz^1 \wedge dz^1 \wedge dz^3$. Take f to be a smooth and strictly plurisubharmonic function on \mathbb{C}^3 . Choose M^5 to be any level set $\{f = k\}$, for $k \in \mathbb{R}$; this is a hypersurface of contact type, with $N = \frac{\nabla f}{|\nabla f|}$ the normalized gradient field (see [23]). The 2-form

$$\omega = Re(\iota_N \Theta)$$

(restricted to M) is a horizontal two-form for this contact structure and satisfies $\omega \wedge d\alpha = 0$, $\omega \wedge \omega = (d\alpha)^2$. Moreover ω is of comass 1 (for the metric induced on M by \mathbb{C}^3), it is therefore a semi-calibration. Then we deduce from proposition 4 that integral cycles semi-calibrated by ω are smooth except possibly at isolated point singularities.

This yields, for example, a regularity result on some **Special Lagrangian** cycles in \mathbb{C}^3 that are invariant under a non-zero vector field. Recall that a current is Special Lagrangian if it is calibrated by the (closed) form $Re(\Theta) = Re(dz^1 \wedge dz^1 \wedge dz^3)$. In particular Special Lagrangians are mass-minimizers.

For example, a Special Lagrangian cycle that is invariant under the gradient flow of a smooth and strictly plurisubharmonic function $f : \mathbb{C}^3 \rightarrow (-\infty, +\infty)$ has, in every bounded region, a singular set made of at most finitely many flow lines of ∇f .

• In the previous framework, we can also recover the Special Legendrians in S^5 . Consider the canonical embedding $\mathcal{E} : S^5 \hookrightarrow \mathbb{C}^3$ and denote by N the radial vector field $N := r \frac{\partial}{\partial r}$ in \mathbb{C}^3 . The sphere inherits from the symplectic manifold $(\mathbb{C}^3, \sum_{i=1}^3 dz^i \wedge d\bar{z}^i)$ the contact structure given by the form

$$\gamma := \mathcal{E}^* \iota_N \left(\sum_{i=1}^3 dz^i \wedge d\bar{z}^i \right).$$

The 3-form $\Omega = Re(dz^1 \wedge dz^2 \wedge dz^3)$ is known as *Special Lagrangian calibration* in \mathbb{C}^3 . The *Special Legendrian semi-calibration* is defined as the following 2-form on S^5 (of comass 1):

$$\omega := \mathcal{E}^* \iota_N \Omega = Re(z_1 dz^2 \wedge dz^3 + z_2 dz^3 \wedge dz^1 + z_3 dz^1 \wedge dz^2).$$

ω -semicalibrated cycles are known as Special Legendrians.

We remark that there is a natural projection $\Pi : S^5 \rightarrow \mathbb{C}\mathbb{P}^2$ (Hopf projection) whose kernel is given by the Reeb vectors of the contact distribution. The Reeb vector field can be integrated to obtain closed orbits which are nothing but the Hopf fibers $e^{i\theta}p$, for $p \in S^5$ and $\theta \in [0, 2\pi)$. Every Special Legendrian curve is projected via Π to a minimal Lagrangian in $\mathbb{C}\mathbb{P}^2$ (see [48]).

- The same as in the first example of this section applies, more generally, in a contact 5-manifold with an $SU(2)$ -structure, as defined in [13]. In the mentioned work, it is proved that, if the data are analytic and hypo, then this 5-manifold embeds in a Calabi-Yau 3-fold. Our regularity result, however, only requires the $SU(2)$ -structure on a contact 5-manifold.

- A special case of interest is that of a Sasaki-Einstein 5-manifold (see [8] and the related notion of hypo-contact $SU(2)$ -structures in [13]). In this case, denoting by α the contact form, the structure I , compatible with $d\alpha$, is integrable on the horizontal subbundle and there exists a holomorphic 2-form Ω that is parallel along the horizontal subbundle: with reference to proposition 4, we can take $\omega = Re(e^{i\phi}\Omega)$, for a fixed $\phi \in [0, 2\pi]$, and get the regularity for ω -semicalibrated cycles.

It is interesting that, in such a contact manifold, a legendrian curve is **minimal** (i.e. the mean curvature vanishes) if and only if it is semicalibrated by $\omega = Re(e^{i\phi}\Omega)$, for a fixed $\phi \in [0, 2\pi]$.

This is the analog of what happens for Lagrangians in Calabi-Yau manifolds (see [30] III.2.D) and the proof is just the same as in that case.

- Let us look at the following situation, [49]. Let S^3 be the unit sphere in \mathbb{R}^4 and consider the following Riemannian 5-manifold

$$N^5 = \{(e_1, e_2) \in S^3 \times S^3 : \langle e_1, e_2 \rangle_{\mathbb{R}^4} = 0\},$$

endowed with the metric inherited from $\mathbb{R}^4 \times \mathbb{R}^4$.

The tangent space to N^5 at a point (e_1, e_2) , is identified with those $U = (U_1, U_2) \in \mathbb{R}^4 \times \mathbb{R}^4$, such that $\langle U_1, e_1 \rangle_{\mathbb{R}^4} = 0$, $\langle U_2, e_2 \rangle_{\mathbb{R}^4} = 0$ and $\langle U_1, e_2 \rangle_{\mathbb{R}^4} + \langle U_2, e_1 \rangle_{\mathbb{R}^4} = 0$.

At every $(e_1, e_2) \in N^5$, consider the tangent vector $v = (-e_2, e_1) \in T_{(e_1, e_2)}N^5$ and take the orthogonal hyperplane $H_{(e_1, e_2)} = v^\perp \subset T_{(e_1, e_2)}N^5$. The distribution H defines a contact structure on N^5 . It can be described by the one-form $\alpha_{(e_1, e_2)}(U) = \frac{1}{2}(\langle e_1, U_2 \rangle_{\mathbb{R}^4} - \langle e_2, U_1 \rangle_{\mathbb{R}^4})$ with associated symplectic form $\Omega(U, V) = \langle U_1, V_2 \rangle_{\mathbb{R}^4} - \langle V_1, U_2 \rangle_{\mathbb{R}^4}$.

By integrating the Reeb vectors v , we get closed fibers isomorphic to S^1 of the form

$$\{(\cos \theta e_1 - \sin \theta e_2, \sin \theta e_1 + \cos \theta e_2)\}_{\theta \in [0, 2\pi)}.$$

The map²⁸

$$\begin{aligned} \Pi : N^5 &\rightarrow G_2(\mathbb{R}^4) \cong \mathbb{C}\mathbb{P}^1 \times \mathbb{C}\mathbb{P}^1 \\ (e_1, e_2) &\rightarrow e_1 \wedge e_2 \end{aligned}$$

is an orthogonal projection whose kernel is given by the Reeb vectors.

Define the following 2-form on N^5

$$\omega(U, V) := e_1 \wedge e_2 \wedge (U_1 \wedge V_2 - V_1 \wedge U_2),$$

for U, V tangent vectors to N^5 at (e_1, e_2) .

It can be checked that ω is a horizontal form of comass 1 and our regularity result applies to ω -semicalibrated cycles.

- In [61], the authors introduce the notions of Contact Calabi-Yau manifolds and Special Legendrians in Contact Calabi-Yau manifolds. With regard to the notation in [61], the two-form $Re \epsilon$ is a calibration (it is assumed to be closed) and Proposition 4 yields the regularity of calibrated cycles in dimension 5. We still get the regularity result if we drop the closedness assumption on ϵ .

What else? We conclude with a short motivational digression regarding theorem 3.0.2, in connection to general calibrations.

For a general calibrating 2-form φ in a 5-dimensional manifold M , let us look, at every point, at the set \mathcal{G}_φ of calibrated 2-planes: as explained in [30] (Thm. II 7.16) or [34] (Thm. 4.3.2), there exist suitable orthogonal coordinates at the chosen point such that \mathcal{G}_φ is the same as the set of 2-planes calibrated by one of the following canonical forms

$$dx^1 \wedge dx^2 + dx^3 \wedge dx^4 \quad \text{or} \quad dx^1 \wedge dx^2.$$

At the points where the first case is realized, we can define an almost complex structure J such that calibrated 2-planes are identified with the J -invariant ones. If moreover the manifold M is contact, then, as we already discussed, a calibrated manifold (or also an integer multiplicity rectifiable current) can have as tangents only those J -invariant planes which are Lagrangian for the symplectic form on the horizontal distribution. Therefore, if we require the calibration to admit, for every point p and calibrated 2-plane Π at p , a calibrated submanifold passing through p with tangent Π , the corresponding J must fulfil conditions (3.8) and (3.9).

²⁸Here $G_2(\mathbb{R}^4)$ denotes the Grassmannian of 2-planes in \mathbb{R}^4 . We have the identification $G_2(\mathbb{R}^4) \cong \mathbb{C}\mathbb{P}^1 \times \mathbb{C}\mathbb{P}^1$ by splitting into the self-dual and anti self-dual components.

In many instances, a calibration is considered interesting if it admits a lot of calibrated submanifolds²⁹. Indeed, the richer the family of calibrated submanifolds is, more examples of area-minimizing surfaces and their possible singularities can we get. On a contact 5-manifold, therefore, our assumption on J includes, in some sense, the most generic cases of calibrations.

This 5-dimensional situation can be considered as the analogue of the one addressed in [50] and [58] in dimension 4, or in [51] for general even dimension, where the corresponding regularity for J -holomorphic cycles is proven.

²⁹This point of view is present both in [30] and in [34].

Chapter 4

Tangent cones to positive $(1, 1)$ cycles

In this chapter we prove a uniqueness result for tangent cones to positive $(1, 1)$ -De Rham currents of finite mass and zero boundary in arbitrary almost complex manifolds. Absolute uniqueness is known to fail (already in \mathbb{C}^n) and our result applies to non-isolated points of positive density. The key idea is an implementation, for currents in an almost complex setting, of the classical blow up of curves in algebraic or symplectic geometry. Unlike the classical approach in complex manifolds, we cannot rely on plurisubharmonic potentials. The content of this chapter is [6] and an overview was given in section 1.5.3. We nonetheless recall the setting briefly, in order to tress a few important points that are needed later.

Let (\mathcal{M}, J) be a smooth almost complex manifold of dimension $2n + 2$ (with $n \in \mathbb{N}^*$), endowed with a non-degenerate 2-form ω compatible with J . If $d\omega = 0$ then we have a symplectic form, but we will not need to assume closedness. Let g be the associated Riemannian metric, $g(\cdot, \cdot) := \omega(\cdot, J\cdot)$.

The form ω is a semi-calibration on \mathcal{M} . A useful equivalent characterization for the fact that a unit simple 2-vector at x is in \mathcal{G}_x , i.e. it is ω_x -calibrated, is obtained as follows.

Testing on $w_1 \wedge w_2$ such that w_1 and w_2 are unit orthogonal vectors at x for g_x and recalling that J is an othogonal endomorphism of the tangent space we get

$$\omega_x(w_1 \wedge w_2) = 1 \Leftrightarrow g_x(J_x(w_1), w_2) = 1 \Leftrightarrow J_x(w_1) = w_2. \quad (4.1)$$

Thus a 2-plane is in \mathcal{G}_x if an only if it is J_x -invariant or, in other words, if an only if it is J_x -holomorphic.

So an equivalent way to express ω -positiveness for a current T (see section 1.4 for the usual definition) is that $\|T\|$ -a.e. \vec{T} belongs to the convex hull of J -holomorphic simple unit 2-vectors, in particular \vec{T} itself is J -invariant. For this reason ω -positive normal cycles are also called positive (1, 1)-normal cycles. Remarkably the (1, 1)-condition only depends on J , so a positive (1, 1)-cycle is ω -positive for any J -compatible couple (ω, g) .

As described in section 1.5.3, we are concerned with the study of tangent cones to positive (1, 1)-cycles. Consider a dilation of T around x_0 of factor r which, in normal coordinates around x_0 , is expressed by the push-forward of T under the action of the map $\frac{x - x_0}{r}$:

$$(T_{x_0,r} \llcorner B_1)(\psi) := \left[\left(\frac{x - x_0}{r} \right)_* T \right] (\chi_{B_1} \psi) = T \left(\chi_{B_r(x_0)} \left(\frac{x - x_0}{r} \right)^* \psi \right). \quad (4.2)$$

The current $T_{x_0,r}$ is positive for the two-form $\omega_{x_0,r} := \frac{1}{r^2}(r|x - x_0|)^* \omega$ and with respect to the metric $g_{x_0,r}(X, Y) := \frac{1}{r^2}g((r|x - x_0|)_* X, (r|x - x_0|)_* Y)$. We have the equality $M(T_{x_0,r} \llcorner B_1) = \frac{M(T \llcorner B_r(x_0))}{r^2}$, where the masses are computed respectively with respect to $g_{x_0,r}$ and g .

The fact that $\frac{M(T \llcorner B_r(x_0))}{r^2}$ is monotonically almost-decreasing as $r \downarrow 0$ gives that, for $r \leq r_0$ (for a small enough r_0), we are dealing with a family of currents $\{T_{x_0,r} \llcorner B_1\}$ that satisfy the hypothesis of Federer-Fleming's compactness theorem (see [28] page 141) with respect to the flat metric (the metrics $g_{x_0,r}$ converge, as $r \rightarrow 0$, uniformly to the flat metric g_0).

Thus there exist a sequence $r_n \rightarrow 0$ and a rectifiable boundaryless current T_∞ such that

$$T_{x_0,r_n} \llcorner B_1 \rightarrow T_\infty.$$

This procedure is called the *blow up limit* and the idea goes back to De Giorgi [17]. Any such limit T_∞ turns out to be a cone (a so called **tangent cone** to T at x_0) with density at the origin the same as the density of T at x_0 . Moreover T_∞ is ω_{x_0} -positive.

The main issue regarding tangent cones is whether the limit T_∞ depends or not on the sequence $r_n \downarrow 0$ yielded by the compactness theorem, i.e. whether T_∞ is **unique or not**. This question was already raised in [30] and much is still to be found out.

The fact that a current possesses a unique tangent cone is a symptom of regularity, roughly speaking of regularity at infinitesimal level. It is generally expected that currents minimizing (or almost-minimizing) functionals such

as the mass should have fairly good regularity properties. This issues are however hard in general.

As discussed in section 1.5.3, the uniqueness of tangent cones is only known for some particular classes of integral currents. Passing normal currents, things get harder and the uniqueness of tangent cones to ω -positive normal 2-cycles **fails** in general, already in the case of the complex manifold (\mathbb{C}^n, J_0) , where J_0 is the standard complex structure: this was proven by Kiselman [36]. Further works extended the result to arbitrary dimension and codimension (see [9] and [10], where conditions on the rate of convergence of the mass ratio are given, under which uniqueness holds).

While in the integrable case (\mathbb{C}^n, J_0) positive cycles have been studied quite extensively, there are no results available for $(1, 1)$ cycles when the structure J is *almost complex*.

In this work we prove the following result:

Theorem 4.0.1. *Given an almost complex $(2n + 2)$ -dimensional manifold $(\mathcal{M}, J, \omega, g)$ as above, let T be a $(1, 1)$ -normal cycle, i.e. a ω -positive normal 2-cycle.*

Let x_0 be a point of positive density $\nu(x_0) > 0$ and assume that there is a sequence $x_m \rightarrow x_0$ of points $x_m \neq x_0$ all having positive densities $\nu(x_m)$ and such that $\nu(x_m) \rightarrow \nu(x_0)$.

Then the tangent cone at x_0 is unique and is given by $\nu(x_0)[[D]]$ for a certain J_{x_0} -invariant disk D .

The notation $[[D]]$ stands for the current of integration on D . Our proof actually yields the stronger result stated in theorem 4.1.1.

In the integrable case, theorem 4.0.1 follows from Siu's result [56], but in the almost complex setting techniques ought to be different, due to the lack of a plurisubharmonic potential for the current.

In a certain sense Siu's result shows that, in the integrable case, unique continuation is still valid for positive $(1, 1)$ -cycles if we only look at points of positive density. Then we can roughly rephrase theorem 4.0.1 by saying that unique continuation is valid at the infinitesimal level for these points.

In the next section we recall some facts on monotonicity and tangent cones for ω -positive cycles and state the stronger theorem 4.1.1.

In section 4.2 we construct suitable coordinates, used in section 4.3 for the almost complex implementation of the algebraic blow up. In section 4.3 we also prove that the proper transform actually yields a current of finite mass and without boundary. The appendix contains two lemmas: pseudo

holomorphic maps preserve both the (1, 1)-condition and the densities. With all this, in section 4.4 we conclude the proof.

In section 4.5, for sake of completeness, we revisit the main aspects in the counterexample [36] to the general uniqueness of tangent cones; the algebraic blow up proves effective for a clearer picture of the geometry of this counterexample.

4.1 Tangent cones to (1, 1)-normal cycles.

Given an almost complex $(2n + 2)$ -dimensional manifold $(\mathcal{M}, J, \omega, g)$, let T be a ω -positive normal 2-cycle. Tangent cones are a local matter, it suffices then to work in a chart around the point under investigation.

One of the key properties of positive currents is the following *almost monotonicity property* for the mass-ratio. The statement here follows from proposition 11 in the appendix, which is in turn borrowed from [47].

Proposition 9. *Let T be a ω -positive normal cycle in an open and bounded set of \mathbb{R}^{2n+2} , endowed with a metric g and a semicalibration ω . We assume that g and ω are L -Lipschitz for some constant $L > 1$ and that $\frac{1}{5}\mathbb{I} \leq g \leq 5\mathbb{I}$, where \mathbb{I} is the identity matrix, representing the flat metric.*

Let $B_r(x_0)$ be the ball of radius r around x_0 with respect to the metric g_{x_0} and let M be the mass computed with respect to the metric g . There exists $r_0 > 0$ depending only on L such that, for any x_0 and for $r \leq r_0$ the mass ratio $\frac{M(T \llcorner B_r(x_0))}{\pi r^2}$ is an almost-increasing function in r , i.e. $\frac{M(T \llcorner B_r(x_0))}{\pi r^2} = R(r) + o_r(1)$ for a function R that is monotonically non-increasing as $r \downarrow 0$ and a function $o_r(1)$ which is infinitesimal of r .

Independently of x_0 , the perturbation term $o_r(1)$ is bounded in modulus by $C \cdot L \cdot r$, where C is a universal constant.

The fact that r_0 and C do not depend on the point yield that the density $\nu(x)$ of T is an upper semi-continuous function; the proof is rather standard.

Another very important consequence of monotonicity is that the mass is continuous and not just lower semi-continuous under weak convergence of semicalibrated or positive cycles. Basically this is due to the fact that computing mass for a ω -positive cycle amounts to testing it on the form ω , as described in (1.4); testing on forms is exactly how weak convergence is defined.

This fact is of key importance for this work and will be formally proved when needed (see (4.26) in section 4.4).

Let us now focus on tangent cones. If we perform the blow up procedure around a point of density 0, then the limiting cone is unique and is the zero-current. So in this situation there is no issue about the uniqueness of the tangent cone.

We are therefore interested in the limiting behaviour around a point x_0 of strictly positive density $\nu(x_0) > 0$.

From [9] we know that any normal positive 2-cone in \mathbb{C}^{n+1} is a positive Radon measure on $\mathbb{C}\mathbb{P}^n$. Combining¹ this with the fact that a tangent cone T_∞ at x_0 to a ω -positive cycle is ω_{x_0} -positive and has density $\nu(x_0)$ at the vertex, we get that T_∞ is represented by a Radon measure, with total measure $\nu(x_0)$, on the set of ω_{x_0} -calibrated 2-planes. Precisely, there exists a positive Radon measure τ on $\mathbb{C}\mathbb{P}^n$ such that, denoting by D^X the unit disk in $B_1^{2n+2}(0)$ corresponding to $X \in \mathbb{C}\mathbb{P}^n$, the action of T_∞ on any two-form β is expressed as

$$T_\infty(\beta) = \int_{\mathbb{C}\mathbb{P}^n} \left\{ \int_{D^X} \langle \beta, \vec{D}^X \rangle d\mathcal{L}^2 \right\} d\tau(X). \quad (4.3)$$

Let x_0 be a point of positive density $\nu(x_0) > 0$ and assume that there is a sequence $x_m \rightarrow x_0$ of points of positive density $\nu(x_m) \geq \kappa > 0$ for a fixed $\kappa > 0$. By upper-semicontinuity of ν it must be $\nu(x_0) \geq \kappa$.

Blow up around x_0 for the sequence of radii $|x_m - x_0|$: up to a subsequence we get a tangent cone T_∞ . What can we immediately say about this cone?

With these dilations, the currents $T_{x_0, |x_m - x_0|}$ always have a point $y_m := \frac{x_m - x_0}{|x_m - x_0|}$ on the boundary of B_1 with density $\nu(y_m) \geq \kappa$. By compactness we can assume $y_m \rightarrow y \in \partial B_1$. By monotonicity, for any fixed $\delta > 0$, localizing to the ball $B_\delta(y)$ we find, using (1.4) and recalling from (4.2) that T_∞ and $T_{x_0, r}$ are positive respectively for ω_{x_0} and $\omega_{x_0, r}$,

$$\begin{aligned} M(T_\infty \llcorner B_\delta(y)) &= T_\infty(\chi_{B_\delta(y)} \omega_{x_0}) = \lim_m T_{x_0, |x_m - x_0|}(\chi_{B_\delta(y)} \omega_{x_0}) = \\ &= \lim_m T_{x_0, |x_m - x_0|} \left[\frac{\chi_{B_\delta(y)}}{|x_m - x_0|^2} (|x_m - x_0|(x - x_0))^* \omega \right] = \\ &= \lim_m M(T_{x_0, |x_m - x_0|} \llcorner B_\delta(y)) \geq \kappa \pi \delta^2, \end{aligned}$$

which² implies that y has density $\nu(y) \geq \kappa$.

¹As explained in [36] and [9], the family of possible tangent cones at a point x_0 must be a convex and connected subset of the space of ω_{x_0} -positive cones with density $\nu(x_0)$.

²This computation is an instance of the fact that the mass is continuous under weak convergence of positive currents, unlike the general case when it is just lower semi-continuous.

Therefore T_∞ “must contain” $\kappa\llbracket D \rrbracket$, where D is the holomorphic disk through 0 and y ; i.e. $T_\infty - \kappa\llbracket D \rrbracket$ is a ω_{x_0} -positive cone having density $\nu(x_0) - \kappa$ at the vertex.

More precisely, what we have just shown the following well-known

Lemma 4.1.1. *Let x_0 be a point of positive density $\nu(x_0) > 0$ and assume that there is a sequence $x_m \rightarrow x_0$, $x_m \neq x_0$, of points of positive density $\nu(x_m) \geq \kappa > 0$ for a fixed $\kappa > 0$. Let $\{y_\alpha\}_{\alpha \in A}$ be the set of accumulation points on ∂B_1 for the sequence $y_m := \frac{x_m - x_0}{|x_m - x_0|}$. Let D_α be the holomorphic disk through 0 and y_α (for the structure J_{x_0}). Then for every $\alpha \in A$ there is at least a tangent cone to T at x_0 of the form $\kappa\llbracket D_\alpha \rrbracket + \tilde{T}_\alpha$, for a ω_{x_0} -positive cone \tilde{T}_α .*

In other words, each $\kappa\llbracket D_\alpha \rrbracket$ “must appear” in at least one tangent cone. What about all other (possibly different) tangent cones that we get by choosing different sequences of radii?

The following result shows that **any** tangent cone to T at x_0 “must contain” each disk $\kappa\llbracket D_\alpha \rrbracket$, for all $\alpha \in A$. Let $H : S^{2n+1} \rightarrow \mathbb{C}\mathbb{P}^n$ be the standard Hopf projection.

Theorem 4.1.1. *Given an almost complex $(2n + 2)$ -dimensional manifold $(\mathcal{M}, J, \omega, g)$, let T be a ω -positive normal 2-cycle.*

Let x_0 be a point of positive density $\nu(x_0) > 0$ and assume that there is a sequence of points $\{x_m\}$ such that $x_m \rightarrow x_0$, $x_m \neq x_0$ and the x_m have positive density $\nu(x_m) \geq \kappa$ for a fixed $\kappa > 0$.

Let $\{y_\alpha\}_{\alpha \in A}$ be the set of accumulation points in $\mathbb{C}\mathbb{P}^n$ for the sequence $y_m := H\left(\frac{x_m - x_0}{|x_m - x_0|}\right)$. Let D_α be the holomorphic (for the structure J_{x_0}) disk in $T_{x_0}\mathcal{M}$ containing 0 and $H^{-1}(y_\alpha)$.

Then the points y_α ’s are finitely many and any tangent cone T_∞ to T at x_0 is such that $T_\infty - \bigoplus_\alpha \kappa\llbracket D_\alpha \rrbracket$, is a ω_{x_0} -positive cone.

Remark 4.1.1. It follows that the cardinality of the y_α ’s is bounded by $\left\lceil \frac{\nu(x_0)}{\kappa} \right\rceil$. In particular, theorem 4.0.1 follows from this result.

4.2 Pseudo holomorphic polar coordinates

T is ω -positive 2-cycle of finite mass in a $(2n + 2)$ -dimensional almost complex manifold endowed with a compatible metric and form, $(\mathcal{M}, J, \omega, g)$; T is also called a positive (1, 1)-normal cycle.

Since tangent cones to T at a point x_0 are a local issue it suffices to work in a chart. We can assume straight from the beginning to work in the geodesic

ball of radius 2, in normal coordinates centered at x_0 ; for this purpose it is enough to start with the current T already dilated enough around x_0 . Always up to a dilation, without loss of generality we can actually start with the following situation.

T is a ω -positive normal cycle in the unit ball $B_2^{2n+2}(0)$, the coordinates are normal, J is the standard complex structure at the origin, ω is the standard symplectic form at the origin, $\|\omega - \omega_0\|_{C^{2,\nu}(B_2^{2n+2})}$ and $\|J - J_0\|_{C^{2,\nu}(B_2^{2n+2})}$ are small enough.

The dilations needed for the blow up are expressed by the map $\frac{x}{r}$ for $r > 0$ (we are in a normal chart centered at the origin). So in these coordinates we need to look at the family of currents

$$T_{0,r} := \left(\frac{x}{r}\right)_* T.$$

It turns out effective, however, to work in coordinates adapted to the almost-complex structure, as we are going to explain in this section.

With coordinates (z_0, \dots, z_n) in \mathbb{C}^{n+1} , we use the notation (ε is a small positive number)

$$\tilde{\mathcal{S}}_\varepsilon := \{(z_0, z_1, \dots, z_n) \in B_{1+\varepsilon}^{2n+2} \subset \mathbb{C}^{n+1} : |(z_1, \dots, z_n)| < (1 + \varepsilon)|z_0|\}. \quad (4.4)$$

We have a canonical identification of $X = [z_0, z_1, \dots, z_n] \in \mathbb{C}\mathbb{P}^n$ with the 2-dimensional plane $D^X = \{\zeta(z_0, z_1, \dots, z_n) : \zeta \in \mathbb{C}\}$, which is complex for the standard structure J_0 .

As X ranges in the open ball

$$\mathcal{V}_\varepsilon \subset \mathbb{C}\mathbb{P}^n, \quad \mathcal{V}_\varepsilon := \{[z_0, z_1, \dots, z_n] : |(z_1, \dots, z_n)| < (1 + \varepsilon)|z_0|\},$$

the planes D^X foliate the sector $\tilde{\mathcal{S}}_\varepsilon$. We thus canonically get a *polar foliation* of the sector, by means of holomorphic disks.

Let the ball (of radius 2) $B_2^{2n+2} \subset \mathbb{R}^{2n+2}$ be endowed with an almost complex structure J . The same set as in (4.4), this time thought of as a subset of (B_2^{2n+2}, J) , will be denoted by \mathcal{S}_ε .

We can get a *polar foliation* of the sector \mathcal{S}_0 , by means of J -pseudo holomorphic disks; this is achieved by perturbing the canonical foliation exhibited for $\tilde{\mathcal{S}}_\varepsilon$. The case $n = 1$ is lemma A.2 in the appendix of [50], the proof is however valid for any n : here is the statement.

Existence of a J -pseudo holomorphic polar foliation. There exists $\alpha_0 > 0$ small enough such that, if $\|J - J_0\|_{C^{2,\nu}(B_2^{2n+2})} < \alpha_0$ and $J = J_0$ at the origin, then the following holds.

There exists a diffeomorphism

$$\Psi : \tilde{\mathcal{S}}_\varepsilon \rightarrow (B_2^{2n+2}, J) , \quad (4.5)$$

continuous up to the origin, with $\Psi(0) = 0$, with the following properties (see top picture of figure 4.1):

- (i) Ψ sends the 2-disk $D^X \cap \tilde{\mathcal{S}}_\varepsilon$ represented by $X = [z_0, z_1, \dots, z_n] \in \mathbb{C}\mathbb{P}^n$ to an embedded J -pseudo holomorphic disk through 0 with tangent D^X at the origin;
- (ii) the image of Ψ contains $\mathcal{S}_0 = B_1^{2n+2} \cap \{|(z_1, \dots, z_n)| < |z_0|\}$;
- (iii) $\|\Psi - Id\|_{C^{2,\nu}(\mathcal{S}_\varepsilon)} < C_0$, where C_0 is a positive constant that can be made as small as wished by assuming α_0 small enough.

The collection $\{\Psi(D^Y) : Y \in \mathcal{V}_\varepsilon\}$ of these embedded J -pseudo holomorphic disks foliates a neighbourhood of the sector \mathcal{S}_0 ; we will call it a *J -pseudo holomorphic polar foliation*.

The proof (see [50]) also shows that, in order to foliate \mathcal{S}_0 , the ε needed in (4.5) can be made small by taking α_0 small enough.

Rescale the foliation. We are now going to use this *polar foliation* to construct coordinates adapted to J .

The result in [50] actually shows that there exists α_0 such that for all $\alpha \in [0, \alpha_0]$, if $\|J - J_0\|_{C^{2,\nu}(B_2^{2n+2})} = \alpha$ and $J = J_0$ at the origin, then there is a map Ψ_α yielding a polar foliation with $\|\Psi_\alpha - Id\|_{C^{2,\nu}(\mathcal{S}_\varepsilon)} < o_\alpha(1)$ (an infinitesimal of α).

We make use however only of the result for α_0 , as we are about to explain. When we dilate the current T in normal coordinates with a factor r and look at the dilated current in the new ball B_2^{2n+2} , we find that it is of type (1, 1) for J_r , where $J_r := (\lambda_r^{-1})^* J$, i.e. $J_r(V) := (\lambda_r)_*[J((\lambda_r^{-1})_* V)]$.

As $r \rightarrow 0$ it holds $\|J_r - J_0\|_{C^{2,\nu}(B_2^{2n+2})} \rightarrow 0$. Once we have applied the existence result of the J -pseudo holomorphic polar foliation to the ball B_2^{2n+2} endowed with J (assuming $\|J - J_0\|_{C^2} < \alpha_0$), then we get a J_r -pseudo holomorphic polar foliation of (B_2, J_r) just as follows.

Let $\tilde{\lambda}_r$ be the dilation (in euclidean coordinates) $x \rightarrow \frac{x}{r}$; we use the tilda to remind that we are in $\tilde{\mathcal{S}}_\varepsilon$. The same dilation in normal coordinates in $\Psi(\mathcal{S}_\varepsilon) \subset (B_2^{2n+2}, J)$ is denoted by λ_r . Introduce the map (see figure 4.1)

$$\begin{aligned} \Psi_r : \tilde{\mathcal{S}}_\varepsilon &\rightarrow (B_2^{2n+2}, J_r) \\ x &\rightarrow \lambda_r \circ \Psi \circ \tilde{\lambda}_r^{-1}(x). \end{aligned} \quad (4.6)$$

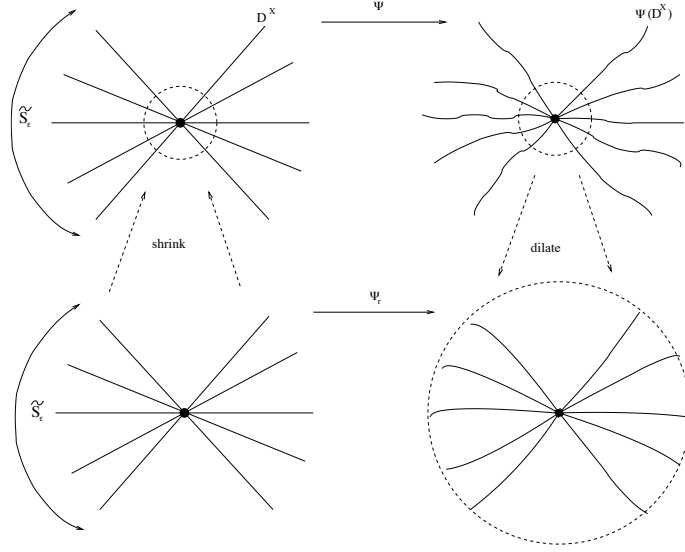

Figure 4.1: J -pseudo holomorphic polar foliation via Ψ and J_r -pseudo holomorphic polar foliation via Ψ_r .

Ψ_r clearly yields a J_r -pseudo holomorphic polar foliation for the ball B_2^{2n+2} endowed with J_r . Remark, in view of (4.10), that Ψ_r can actually be defined on the sector $\tilde{\lambda}_r(\tilde{\mathcal{S}}_\varepsilon)$.

From the proof in [50] we get that³ $\Psi_r \rightarrow Id$ in $C^1(\mathcal{S}_\varepsilon)$ as $r \rightarrow 0$.

Adapted coordinates. The aim is to pull back the problem on $\tilde{\mathcal{S}}_\varepsilon$ via Ψ . Endow for this purpose $\tilde{\mathcal{S}}_\varepsilon$ with the almost complex structure Ψ^*J .

Recall that we have in mind to look at $T_{0,r}$ in (B_2^{2n+2}, J_r) as $r \rightarrow 0$. So we are going to study the family

$$(\Psi_r^{-1})_* \left[T_{0,r} \llcorner \left(\Psi_r(\tilde{\mathcal{S}}_\varepsilon) \right) \right]$$

as $r \rightarrow 0$. For each $r > 0$ these currents are $(1, 1)$ -normal cycles in $\tilde{\mathcal{S}}_\varepsilon$ endowed with the almost complex structure $\Psi_r^*J_r$, as proved in lemma B.0.1.

It is elementary to check that

$$\Psi_r^*J_r = (\tilde{\lambda}_r^{-1})^*\Psi^*\lambda_r^*J_r = (\tilde{\lambda}_r^{-1})^*\Psi^*J,$$

so we can equivalently look, for $r > 0$, at $\tilde{\mathcal{S}}_\varepsilon$ with the almost complex structure $(\tilde{\lambda}_r^{-1})^*\Psi^*J$. The latter is obtained from $(\tilde{\mathcal{S}}_\varepsilon, \Psi^*J)$ by dilation. Remark

³This follows, with reference to the notation in [50], by observing that the map Ξ_q on page 84 (associated to the diffeomorphism that we called Ψ) satisfies $\Xi_q \rightarrow Id$ uniformly as $q \rightarrow 0$, by the condition that above we called (i). Then the $C^{1,\nu}$ bounds there and Ascoli-Arzelà's theorem yield that $\Psi_r \rightarrow Id$ in C^1 .

that $\Psi_r^* J_r \rightarrow J_0$ in C^0 as $r \rightarrow 0$; moreover, assuming α_0 small enough, the fact that $D\Psi$ is C^0 -close to \mathbb{I} yields $|\nabla(\Psi^* J)| \leq 2|\nabla J|$.

We are looking, in normal coordinates, at a sequence $T_{0,r_n} := (\lambda_{r_n})_* T = \left(\frac{x}{r_n}\right)_* T \rightarrow T_\infty$. Restricting to $\Psi_{r_n}(\tilde{\mathcal{S}}_\varepsilon)$, i.e. $T_{0,r_n} \llcorner \Psi_{r_n}(\tilde{\mathcal{S}}_\varepsilon)$, we pull back the problem on $\tilde{\mathcal{S}}_\varepsilon$ and look at

$$(\Psi_{r_n}^{-1})_* \left(T_{0,r_n} \llcorner \Psi_{r_n}(\tilde{\mathcal{S}}_\varepsilon) \right). \quad (4.7)$$

Recalling that $\Psi_r \rightarrow Id$ in C^1 and that T_{0,r_n} have equibounded masses we have, for any two-form β ,

$$(\Psi_{r_n}^{-1})_* \left(T_{0,r_n} \llcorner \Psi_{r_n}(\tilde{\mathcal{S}}_\varepsilon) \right) (\beta) - (Id)_* \left(T_{0,r_n} \llcorner \Psi_{r_n}(\tilde{\mathcal{S}}_\varepsilon) \right) (\beta) \rightarrow 0. \quad (4.8)$$

This follows with a proof as in step 2 of lemma B.0.2, by writing the difference $(\Psi_{r_n}^{-1})_* \beta - Id_* \beta$ in terms of the coefficients of β . Then from (4.7) and (4.8) we get

$$\lim_{n \rightarrow \infty} (\Psi_{r_n}^{-1})_* \left(T_{0,r_n} \llcorner \Psi_{r_n}(\tilde{\mathcal{S}}_\varepsilon) \right) = \left(\lim_{n \rightarrow \infty} (\lambda_{r_n})_* T \right) \llcorner \mathcal{S}_\varepsilon. \quad (4.9)$$

In the last equality we are identifying the space with the tilda and the one without. On the other hand by (4.5) we have

$$\begin{aligned} (\Psi_{r_n}^{-1})_* \left(T_{0,r_n} \llcorner \Psi_{r_n}(\tilde{\mathcal{S}}_\varepsilon) \right) &= \left[(\Psi_{r_n}^{-1})_* \lambda_{r_n} \left(T \llcorner \Psi(\tilde{\mathcal{S}}_\varepsilon) \right) \right] \llcorner \tilde{\mathcal{S}}_\varepsilon \\ &= \left[(\tilde{\lambda}_{r_n})_* (\Psi^{-1})_* \left(T \llcorner \Psi(\tilde{\mathcal{S}}_\varepsilon) \right) \right] \llcorner \tilde{\mathcal{S}}_\varepsilon. \end{aligned} \quad (4.10)$$

What we have obtained with (4.9) and (4.10) is that, using Ψ , we can just pull back T to $\tilde{\mathcal{S}}_\varepsilon$ endowed with $\Psi^* J$, $\Psi^* g$ and $\Psi^* \omega$ and dilate with $\tilde{\lambda}_r$ and observe what happens in the limit. All the possible limits of this family are cones, namely all the possible tangent cones to the original T , restricted to the sector \mathcal{S}_ε .

All the information we need about the family $T_{0,r} \llcorner \mathcal{S}_0$ can be obtained in this way. So we are substituting the blow up in normal coordinates with a different one, that behaves well with respect to J and has the same asymptotic behaviour, i.e. it yields the same cones.

Remark that lemmas B.0.1 and B.0.2 tell us that $(\Psi^{-1})_* \left(T \llcorner \Psi(\tilde{\mathcal{S}}_\varepsilon) \right)$ is still (1, 1) and the densities are preserved. Observe that we cannot use the monotonicity formula for $(\Psi^{-1})_* \left(T \llcorner \Psi(\tilde{\mathcal{S}}_\varepsilon) \right)$ at the origin, since 0 is now a boundary point. However the monotonicity for T reflects into the following

Lemma 4.2.1. *For the current $(\Psi^{-1})_* \left(T\mathbb{L}\Psi(\tilde{\mathcal{S}}_\varepsilon) \right)$, with respect to the flat metric in \mathcal{S}_ε , it holds*

$$\frac{M \left((\Psi^{-1})_* \left(T\mathbb{L}\Psi(\tilde{\mathcal{S}}_\varepsilon) \right) \mathbb{L}(B_r \cap \tilde{\mathcal{S}}_\varepsilon) \right)}{\pi r^2} \leq K \quad (4.11)$$

with a constant K independent of r .

proof of lemma 4.2.1. We denote, only for this proof, by C the current $(\Psi^{-1})_* \left(T\mathbb{L}\Psi(\tilde{\mathcal{S}}_\varepsilon) \right)$. Since $|D\Psi - \mathbb{I}| \leq cr^\nu$ (where $\mathbb{I} = D(Id)$ is the identity matrix) and $g = g_0 + O(r^2)$ (where g_0 is the flat metric), we also get $\Psi^*g = g_0 + O(r^\nu)$.

Comparing the masses of C with respect to g_0 and Ψ^*g we get

$$M_{g_0} \left(C\mathbb{L}(B_r \cap \tilde{\mathcal{S}}_\varepsilon) \right) \leq (1 + |O(r^\nu)|) M_{\Psi^*g} \left(C\mathbb{L}(B_r \cap \tilde{\mathcal{S}}_\varepsilon) \right),$$

where B_r is always euclidean. Now recall that, by the positiveness of the currents,

$$M_{\Psi^*g} \left(C\mathbb{L}(B_r \cap \tilde{\mathcal{S}}_\varepsilon) \right) = \left(C\mathbb{L}(B_r \cap \tilde{\mathcal{S}}_\varepsilon) \right) (\Psi^*\omega) = M_g \left(T\mathbb{L}\Psi(B_r \cap \tilde{\mathcal{S}}_\varepsilon) \right).$$

The condition $|\Psi - Id| \leq cr^{1+\nu}$ implies that $\Psi(B_r \cap \tilde{\mathcal{S}}_\varepsilon) \subset B_{r+cr^{1+\nu}} \cap \mathcal{S}_\varepsilon$. In \mathcal{S}_ε coordinates are normal, so, putting all together:

$$\frac{M_{g_0} \left(C\mathbb{L}(B_r \cap \tilde{\mathcal{S}}_\varepsilon) \right)}{r^2} \leq (1 + |O(r^\nu)|) \frac{(r + cr^{1+\nu})^2}{r^2} \frac{M_g(T\mathbb{L}B_{r+cr^{1+\nu}})}{(r + cr^{1+\nu})^2},$$

which is equibounded in r by almost monotonicity (proposition 9). \square

So we restate our problem in the following terms, where we drop the tildas and the pull-backs (resp. push-forwards) via Ψ (resp. Ψ^{-1}), since there will be no more confusion arising.

New setting: pseudo holomorphic polar coordinates.

Endow $\mathcal{S}_\varepsilon \subset B_2^{2n+2}(0)$ with a smooth almost complex structure J such that, denoting by J_0 the standard complex structure,

- there is $Q > 0$ such that for any $0 < r < 1$, $|J - J_0|_{C^0(\mathcal{S}_\varepsilon \cap B_r)} < Q \cdot r$ and $|\nabla J| < Q$ (and Q can be assumed to be small);

- the 2-planes D^X (for $X \in \mathcal{V}_\varepsilon$) foliating the sector \mathcal{S}_ε are J -pseudo holomorphic.

Let ω and g be respectively a compatible non-degenerate two-form and the associated Riemannian metric such that $\|\omega - \omega_0\|_{C^0(\mathcal{S}_\varepsilon \cap B_r)} < Q \cdot r$ and $\|g - g_0\|_{C^0(\mathcal{S}_\varepsilon \cap B_r)} < Q \cdot r$, where ω_0 and g_0 are the standard ones.

Let T be a normal (1, 1)-cycle in \mathcal{S}_ε .

Study the asymptotic behaviour as $r \rightarrow 0$ of the family $(\lambda_r)_* T$, where $\lambda_r = \frac{Id}{r}$ in euclidean coordinates. More precisely we can restate theorem 4.1.1 as follows; in theorem 4.1.1 we can assume, up to a rotation and passing to a subsequence, that $y_n = \frac{x_n}{|x_n|} \rightarrow (1, 0, \dots, 0)$.

Proposition 10. *With the assumptions just made on J and T , assume that there exists a sequence $x_m \rightarrow 0$, $0 \neq x_m \in \mathcal{S}_\varepsilon$, of points all having densities $\nu(x_m) \geq \kappa$ for a fixed $\kappa > 0$ and such that $y_m := \frac{x_m}{|x_m|} \rightarrow (1, 0, \dots, 0)$. Then any limit*

$$\lim_{r_n \rightarrow 0} (\lambda_{r_n})_* T$$

is a (1, 1)-cone (for J_0) of the form $\kappa[D^{[1,0,\dots,0]}] + \tilde{T}$, where \tilde{T} is also a (1, 1)-cone for J_0 (\tilde{T} possibly depending on $\{r_n\}$).

Remark 4.2.1. As observed in (4.11), our new T satisfies, with respect to the flat metric, $\frac{M(T \llcorner (B_r \cap \mathcal{S}_\varepsilon))}{r^2} \leq K$ for a constant independent of r .

Remark 4.2.2. For the proof of proposition 10 it suffices to understand the asymptotic behaviour of T in \mathcal{S}_0 , which we will just denote by \mathcal{S} . So at some point we will look at $T \llcorner \mathcal{S}$ and this current has boundary on $\partial \mathcal{S}$. Indeed the operation \llcorner is defined in such a way that it yields a current with support in \mathcal{S} , but we still view it as a current in the open set \mathcal{S}_ε .

On the other hand we may wish to look at $T \llcorner \mathcal{S}$ as a current in the open set \mathcal{S} , which means that we only test it against forms compactly supported in \mathcal{S} : in this case T is boundaryless in \mathcal{S} . It will be specified when we wish to do so.

4.3 Algebraic blow up

The classical symplectic (or algebraic) blow up was recalled in the introduction. More details can be found in [41]. $\tilde{\mathbb{C}}^{n+1}$ is a complex line bundle over $\mathbb{C}\mathbb{P}^n$, that we view as an embedded submanifold in $\mathbb{C}\mathbb{P}^n \times \mathbb{C}^{n+1}$. We use standard coordinates on $\mathbb{C}\mathbb{P}^n \times \mathbb{C}^{n+1}$ coming from the product, so we

have $2n$ “horizontal variables” and $2n + 2$ “vertical variables”. The standard symplectic form on $\mathbb{C}\mathbb{P}^n \times \mathbb{C}^{n+1}$ is given by the two form $\vartheta_{\mathbb{C}\mathbb{P}^n} + \vartheta_{\mathbb{C}^{n+1}}$, where $\vartheta_{\mathbb{C}\mathbb{P}^n}$ is the standard symplectic form⁴ on $\mathbb{C}\mathbb{P}^n$ extended to $\mathbb{C}\mathbb{P}^n \times \mathbb{C}^{n+1}$ (so independent of the “vertical variables”) and $\vartheta_{\mathbb{C}^{n+1}}$ is the symplectic two-form on \mathbb{C}^{n+1} , extended to $\mathbb{C}\mathbb{P}^n \times \mathbb{C}^{n+1}$ (so independent of the “horizontal variables”). To $\vartheta_{\mathbb{C}\mathbb{P}^n} + \vartheta_{\mathbb{C}^{n+1}}$ we associate the standard metric, i.e. the product of the Fubini-Study metric on $\mathbb{C}\mathbb{P}^n$ and the flat metric on \mathbb{C}^{n+1} . The associated complex structure is denoted I_0 .

As a complex submanifold, $\tilde{\mathbb{C}}^{n+1}$ inherits from the ambient space a complex structure, still denoted I_0 , and the restricted symplectic form $\vartheta_0 := \mathcal{E}^*(\vartheta_{\mathbb{C}\mathbb{P}^n} + \vartheta_{\mathbb{C}^{n+1}})$, where \mathcal{E} is the embedding in $\mathbb{C}\mathbb{P}^n \times \mathbb{C}^{n+1}$. Let further \mathbf{g}_0 denote the ambient metric restricted to $\tilde{\mathbb{C}}^{n+1}$: \mathbf{g}_0 is then compatible with I_0 and ϑ_0 , i.e. $\vartheta_0(\cdot, \cdot) := \mathbf{g}_0(\cdot, -I_0 \cdot)$.

We now turn to the almost complex situation and will adapt the previous construction by building on the results of section 4.2.

Implementation in the almost complex setting. With the notation

$$\mathcal{S}_\varepsilon = \{(z_0, z_1, \dots, z_n) \in B_{1+\varepsilon}^{2n+2} \subset \mathbb{C}^{n+1} : |(z_1, \dots, z_n)| < (1 + \varepsilon)|z_0|\}$$

as in (4.4), let $\mathcal{S} = \mathcal{S}_0$. Also denote by $\mathcal{V}_\varepsilon := \left\{ \sum_{j=1}^n \frac{|z_j|^2}{|z_0|^2} < 1 + \varepsilon \right\} \subset \mathbb{C}\mathbb{P}^n$ and $\mathcal{V} = \mathcal{V}_0$.

The inverse image $\Phi^{-1}(\mathcal{S}_\varepsilon)$ is given by $\{(\ell, z) \in \mathcal{V}_\varepsilon \times \mathbb{C}^{n+1} : 0 < |z| < 1 + \varepsilon\}$. The union $\Phi^{-1}(\mathcal{S}_\varepsilon) \cup (\mathcal{V}_\varepsilon \times \{0\})$ will be denoted by \mathcal{A}_ε .

\mathcal{A}_ε is an open set in $\tilde{\mathbb{C}}^{n+1}$ but we will endow it with other almost complex structures, different from I_0 , so \mathcal{A}_ε should be thought of just as an oriented manifold and the structure on it will be specified in every instance.

We will keep using the same letters Φ^{-1} and Φ to denote the restricted maps

$$\begin{aligned} \Phi^{-1} : \mathcal{S} &\rightarrow \mathcal{A} \\ \Phi : \mathcal{A} &\rightarrow \mathcal{S} \cup \{0\} \end{aligned} \tag{4.12}$$

also when we look at these spaces just as oriented manifolds (not complex ones). We will make use of the notation

⁴In the chart $\mathbb{C}^n \equiv \{z_0 \neq 0\}$ of $\mathbb{C}\mathbb{P}^n$, the form $\vartheta_{\mathbb{C}\mathbb{P}^n}$ is expressed, using coordinates $Z = (Z_1, \dots, Z_n)$, by $\partial\bar{\partial}f$, where $f = \frac{1}{2} \log(1 + |Z|^2)$ (see [41]). The metric g_{FS} associated to $\vartheta_{\mathbb{C}\mathbb{P}^n}$ and to the standard complex structure is called Fubini-Study metric and it fulfils $\frac{1}{4}\mathbb{I} \leq g_{\text{FS}} \leq 4\mathbb{I}$ when we compare it to the flat metric on the domain $\{|Z| < 1\}$.

$$\mathcal{S}_\rho := \mathcal{S} \cap B_\rho^{2n+2} \text{ and } \mathcal{A}_\rho := \Phi^{-1}(\mathcal{S}_\rho) \cup (\mathcal{V} \times \{0\}).$$

It should be kept in mind that Φ^{-1} and Φ in (4.12) can be extended a bit beyond their boundaries, namely to \mathcal{S}_ε and to $\mathcal{A}_\varepsilon := \Phi^{-1}(\mathcal{S}_\varepsilon) \cup (\mathcal{V}_\varepsilon \times \{0\})$.

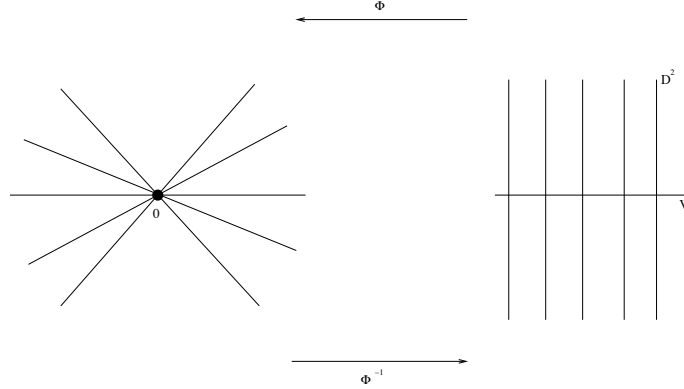

Figure 4.2: Blowing up the origin. The maps $\Phi^{-1} : \mathcal{S} \rightarrow \mathcal{A}$ and $\Phi : \mathcal{A} \rightarrow \mathcal{S} \cup \{0\}$.

Define on $\mathcal{A} \setminus (\mathbb{C}\mathbb{P}^n \times \{0\})$:

- the almost complex structure $I := \Phi^* J$, i.e. $I(\cdot) := (\Phi^{-1})_* J \Phi_*(\cdot)$,
- the metric $\mathbf{g}(\cdot, \cdot) := \mathbf{g}_0(\cdot, \cdot) + \mathbf{g}_0(I\cdot, I\cdot)$,
- the non-degenerate two-form $\vartheta(\cdot, \cdot) := \mathbf{g}(I\cdot, \cdot) = \mathbf{g}_0(I\cdot, \cdot) - \mathbf{g}_0(\cdot, I\cdot)$.

The triple $(I, \mathbf{g}, \vartheta)$ is smooth on $\mathcal{A} \setminus (\mathbb{C}\mathbb{P}^n \times \{0\})$ and makes it an almost complex manifold. We do not know yet, however, the behaviour of $(I, \mathbf{g}, \vartheta)$ as we approach $\mathcal{V} \times \{0\}$.

Lemma 4.3.1 (the new structure is Lipschitz). *The almost complex structure I fulfils*

$$|I - I_0|(\cdot) \leq c \text{dist}_{\mathbf{g}_0}(\cdot, \mathbb{C}\mathbb{P}^n \times \{0\}),$$

for $c = C \cdot Q$, where C is a dimensional constant and Q is as in the hypothesis on J (just before proposition 10). I can thus be extended continuously across $\mathbb{C}\mathbb{P}^n \times \{0\}$.

Analogously we have $|\mathbf{g} - \mathbf{g}_0|(\cdot) \leq c \text{dist}_{\mathbf{g}_0}(\cdot, \mathbb{C}\mathbb{P}^n \times \{0\})$ and $|\vartheta - \vartheta_0|(\cdot) \leq c \text{dist}_{\mathbf{g}_0}(\cdot, \mathbb{C}\mathbb{P}^n \times \{0\})$. The triple $(I, \mathbf{g}, \vartheta)$ can be extended across $\mathbb{C}\mathbb{P}^n \times \{0\}$ to the whole of \mathcal{A} by setting it to be the standard $(I_0, \mathbf{g}_0, \vartheta_0)$ on $\mathbb{C}\mathbb{P}^n \times \{0\}$.

The structures I, \mathbf{g}, ϑ so defined are globally Lipschitz-continuous on \mathcal{A} , with Lipschitz constant $L + C \cdot Q$, where $L > 0$ is an upper bound for the Lipschitz constants of I_0, \mathbf{g}_0 and ϑ_0 .

proof of lemma 4.3.1. Recall that Φ is holomorphic for the standard structures J_0 and I_0 . With respect to the flat metric on \mathcal{S} , we can choose an orthonormal basis at any point $q \neq 0$ made as follows:

$$\{L_1, J_0(L_1), L_2, J_0(L_2), \dots, L_n, J_0(L_n), W, J_0(W)\},$$

where W and $J_0(W)$ span the J_0 -complex 2-plane through the origin and q . The map $(\Phi^{-1})_*$ is holomorphic and sends this basis to one at $(\Phi^{-1})(q) \in \mathcal{A}$, sending W and $I_0(W)$ to a pair of vectors spanning the fiber through $(\Phi^{-1})(q)$. On the vertical vectors $(\Phi^{-1})_*$ is length preserving, while for the others $|(\Phi^{-1})_* L_j| = |(\Phi^{-1})_* J_0(L_j)| = \frac{\sqrt{1+|q|^2}}{|q|}$, as one can compute from the explicit expression of the Fubini-Study metric.

Reversing this construction we can choose two basis, respectively at p and $q = \Phi(p)$, as follows.

$$\{H_1, I_0(H_1), \dots, H_n, I_0(H_n), V, I_0(V)\}$$

made of \mathbf{g}_0 -unit vectors with scalar products w.r.t \mathbf{g}_0 bounded by $\frac{|q|}{\sqrt{1+|q|^2}}$, and

$$\left\{ \frac{\sqrt{1+|q|^2}}{|q|} K_1, \frac{\sqrt{1+|q|^2}}{|q|} J_0(K_1), \dots, \frac{\sqrt{1+|q|^2}}{|q|} K_n, \frac{\sqrt{1+|q|^2}}{|q|} J_0(K_n), W, J_0(W) \right\},$$

orthonormal at $q = \Phi(p)$, such that:

- (i) $K_j := \Phi_* H_j$ and $W := \Phi_* V$;
- (ii) V and $I_0(V)$ are vertical, i.e. they span the vertical fiber through p : by (i), W and $J_0(W)$ span the J_0 -complex 2-plane through the origin and q .

By the assumption that J is close to J_0 in B_1 we can write the action of J on K_1 as

$$\begin{aligned} J(K_1) &= (1 + \lambda) J_0(K_1) + \sum_{j=1}^n \mu_j K_j + \sum_{j=2}^n \tilde{\mu}_j J_0(K_j) + \\ &+ \frac{|q|}{\sqrt{1+|q|^2}} \sigma W_1 + \frac{|q|}{\sqrt{1+|q|^2}} \tilde{\sigma} J_0(W_1). \end{aligned} \tag{4.13}$$

Here $\lambda, \mu_j, \tilde{\mu}_j, \sigma$ and $\tilde{\sigma}$ are functions on \mathcal{S} depending on $J - J_0$, evaluated at q , so their moduli are bounded by $|J - J_0|(q) < Q|q|$.

Let us write the action of I on H_1 explicitly: by definition of I , using (4.13),

$$\begin{aligned} I(H_1) &:= (\Phi^{-1})_* J\Phi_*(H_1) = (\Phi^{-1})_* J(K_1) = \\ &= ((1 + \lambda) \circ \Phi)I_0(H_1) + \sum_{j=1}^n (\mu_j \circ \Phi)H_j + \sum_{j=2}^n (\tilde{\mu}_j \circ \Phi)I_0(K_j) + \\ &\quad + \frac{|q|}{\sqrt{1 + |q|^2}}(\sigma \circ \Phi)V_1 + \frac{|q|}{\sqrt{1 + |q|^2}}(\tilde{\sigma} \circ \Phi)I_0(V_1). \end{aligned} \tag{4.14}$$

Similar expressions are obtained for the actions on H_j and $I_0(H_j)$ for all j . Now

$$J(W) = \sigma W + (1 + \tilde{\sigma})J_0(W),$$

since the 2-plane spanned by W and $J_0(W)$ is J -pseudo holomorphic by hypothesis.

Here σ and $\tilde{\sigma}$ are functions on \mathcal{S} depending on $J - J_0$, evaluated at q , and their moduli are bounded by $|J - J_0| < Q|q|$.

So the action of I on V is explicitly given by

$$\begin{aligned} I(V) &:= (\Phi^{-1})_* J\Phi_*(V) = (\Phi^{-1})_* J(W) = \\ &= (\sigma \circ \Phi)(\Phi^{-1})_*(W) + ((1 + \tilde{\sigma}) \circ \Phi)(\Phi^{-1})_* J_0(W) \\ &= (\sigma \circ \Phi)V + ((1 + \tilde{\sigma}) \circ \Phi)I_0(V). \end{aligned} \tag{4.15}$$

So we have, from (4.14) and (4.15) that there exists $c = C \cdot Q$ (for some dimensional constant C) such that $(I - I_0)$ at the point $p = (\Phi^{-1})(q)$ has norm $\leq c|q| = c \operatorname{dist}_{\mathbf{g}_0}(\cdot, \mathbb{C}\mathbb{P}^n \times \{0\})$.

The analogous estimates on \mathbf{g} and ϑ follow by their definition. So we can extend the triple $(I, \mathbf{g}, \vartheta)$ across $\mathbb{C}\mathbb{P}^n \times \{0\}$ in a Lipschitz continuous fashion.

From (4.14) and (4.15) we also get that I is, globally in \mathcal{A} , a Lipschitz continuous perturbation of I_0 , and the same goes for \mathbf{g} and ϑ : indeed the Lipschitz constants of $\lambda, \mu_j, \tilde{\mu}_j, \sigma$ and $\tilde{\sigma}$ are controlled by $C \cdot Q$, for some dimensional constant C (which can be taken the same as the C above, by choosing the larger of the two).

□

Remark 4.3.1. The importance of working with coordinates adapted to J , as chosen in section 4.2, relies in the fact that this allows to obtain the Lipschitz extension across $\mathbb{C}\mathbb{P}^n \times \{0\}$, which could fail on the vertical vectors if coordinates were taken arbitrary.

The aim is now to **translate our problem** in the new space $(\mathcal{A}, I, g, \vartheta)$. The trouble is that the push-forward of T via Φ^{-1} can only be done away from the origin and the map Φ^{-1} degenerates as we get closer to 0.

For any $\rho > 0$ we can take the *proper transform* of $T\mathbf{L}(\mathcal{S} \setminus \mathcal{S}_\rho)$ by pushing forward via Φ^{-1} , since this is a diffeomorphism away from the origin:

$$P_\rho := (\Phi^{-1})_* (T\mathbf{L}(\mathcal{S} \setminus \mathcal{S}_\rho)).$$

What happens when $\rho \rightarrow 0$? The following two lemmas yield the answers.

Lemma 4.3.2. *The current $P := \lim_{\rho \rightarrow 0} P_\rho = \lim_{\rho \rightarrow 0} (\Phi^{-1})_* (T\mathbf{L}(\mathcal{S} \setminus \mathcal{S}_\rho))$ is well-defined as the limit of currents of equibounded mass to be a current of finite mass in \mathcal{A} .*

The mass of P , both with respect to \mathbf{g} and to \mathbf{g}_0 , is bounded by a dimensional constant C times the mass of T .

Lemma 4.3.3. *The current $P := \lim_{\rho \rightarrow 0} P_\rho = \lim_{\rho \rightarrow 0} (\Phi^{-1})_* (T\mathbf{L}(\mathcal{S} \setminus \mathcal{S}_\rho))$ is a ϑ -positive normal cycle in the open set \mathcal{A} .*

A little notation before the proofs. For any ρ consider the dilation $\lambda_\rho(\cdot) := \frac{\cdot}{\rho}$, sending B_ρ to B_1 , and the map

$$\Lambda_\rho : \mathcal{A}_\rho \rightarrow \mathcal{A}, \quad \Lambda_\rho := \Phi^{-1} \circ \lambda_\rho \circ \Phi, \quad (4.16)$$

which in the coordinates of $\mathbb{C}\mathbb{P}^n \times \mathbb{C}^{n+1}$ reads $\Lambda_\rho(\ell, z) = \left(\ell, \frac{z}{\rho}\right)$.

proof of lemma 4.3.2. The currents T and $T_{0,r}$ are defined in \mathcal{S}_ε and by remark 4.2.1, i.e. by the monotonicity formula, we have a uniform bound on the masses: $M(T_{0,r}) \leq K$.

The map Φ^{-1} is pseudo holomorphic with respect to J and I by definition of I ; thus each $P_\rho = (\Phi^{-1})_* (T\mathbf{L}(\mathcal{S} \setminus \mathcal{S}_\rho))$ is ϑ -positive by construction (see lemma B.0.1), so $M(P_\rho) = P_\rho(\vartheta)$, where the mass is computed here with respect to g , the metric defined before lemma 4.3.1. The currents P_ρ and $P_{\rho'}$, for $\rho > \rho'$, coincide on $\mathcal{A} \setminus \overline{\mathcal{A}_\rho}$, therefore in order to study the limit as $\rho \rightarrow 0$, it is enough to look at a chosen sequence $\rho_k \rightarrow 0$ and prove that P_{ρ_k} have

equibounded masses and thus converge to a limit P , which must then be the limit of the whole family P_ρ .

1st step: choice of the sequence. Denote by $\langle T, |z| = r \rangle$ the slice of a current T with the sphere ∂B_r . Choose ρ_k so to ensure

- (i) $T_{\rho_k} \rightharpoonup T_\infty$ in \mathcal{S} for a certain cone T_∞ ,
- (ii) $M(\langle T_{\rho_k}, |z| = 1 \rangle)$ are equibounded by $4K$.

This is achieved as follows: take a sequence ρ'_k fulfilling (i); remark 4.2.1 tells us that $M(T_{\rho'_k})$ are equibounded by a constant K independent of k . By slicing theory (see [28])

$$\int_{\frac{1}{2}}^1 M(\langle T_{\rho'_k}, |z| = r \rangle) dr \leq M(T_{\rho'_k} \llcorner (B_1 \setminus B_{\frac{1}{2}})) \leq K,$$

thus at least half of the slices $\langle T_{\rho'_k}, |z| = r \rangle_{r \in [\frac{1}{2}, 1]}$ have masses $\leq 2K$. For every k we can choose $\frac{1}{2} \leq s_k \leq 1$ such that all the slices $\langle T_{\rho'_k}, |z| = s_k \rangle$ exist and have mass $\leq 2K$. Then with $\rho_k = s_k \rho'_k$ it holds

$$M(\langle T_{\rho_k}, |z| = 1 \rangle) = M\left(\left(\lambda_{\frac{\rho_k}{\rho'_k}}\right)_* \left\langle T_{\rho'_k}, |z| = s_k = \frac{\rho_k}{\rho'_k} \right\rangle\right) \leq 2 \cdot 2K$$

and since $\frac{\rho'_k}{2} \leq \rho_k \leq \rho'_k$ the sequence T_{ρ_k} also converges to the same T_∞ .

Since $\langle T_{\rho_k}, |z| = 1 \rangle = (\lambda_{\rho_k})_* \langle T, |z| = \rho_k \rangle$, condition (ii) also reads

$$M(\langle T, |z| = \rho_k \rangle) \leq 4K\rho_k. \quad (4.17)$$

2nd step: uniform bound on the masses. We use in \mathcal{A} standard coordinates inherited from $\mathbb{C}\mathbb{P}^n \times \mathbb{C}^{n+1}$, i.e. we have $2n$ horizontal variables (from $\mathbb{C}\mathbb{P}^n$) and $2n + 2$ vertical variables.

The standard symplectic form ϑ_0 is $\mathcal{E}^*(\vartheta_{\mathbb{C}\mathbb{P}^n} + \vartheta_{\mathbb{C}^{n+1}})$, as in the beginning of section 4.3. We want to estimate $M(P_\rho) = P_\rho(\vartheta) = P_\rho(\vartheta_0) + P_\rho(\vartheta - \vartheta_0)$.

Let us first deal with $P_\rho(\mathcal{E}^*\vartheta_{\mathbb{C}\mathbb{P}^n}) = T_{0,\rho} \llcorner (\mathcal{S} \setminus \mathcal{S}_\rho)((\Phi^{-1})^*\mathcal{E}^*\vartheta_{\mathbb{C}\mathbb{P}^n})$. It is convenient here to keep in mind that ϑ_0 is actually defined on \mathcal{A}_ε and consider $(\Phi^{-1})^*\mathcal{E}^*\vartheta_{\mathbb{C}\mathbb{P}^n}$ as a form on \mathcal{S}_ε , since Φ^{-1} also extends to \mathcal{S}_ε . The map $\mathcal{E} \circ \Phi^{-1} : \mathcal{S}_\varepsilon \rightarrow \mathcal{A}_\varepsilon$ has the coordinate expression $(z_0, \dots, z_n) \rightarrow \left(\left(\frac{z_1}{z_0}, \dots, \frac{z_n}{z_0} \right), (z_0, \dots, z_n) \right) \in \mathcal{V}_\varepsilon \times \mathbb{C}^{n+1}$, using the chart $z_0 \neq 0$ on $\mathcal{V}_\varepsilon \subset \mathbb{C}\mathbb{P}^n$.

Using the explicit expression of $\vartheta_{\mathbb{C}\mathbb{P}^n}$ (see [41] and the beginning of this section) we can write in the domain \mathcal{S}_ε , where $z_0 \neq 0$,

$$(\Phi^{-1})^* \mathcal{E}^*(\vartheta_{\mathbb{C}\mathbb{P}^n}) = \partial \bar{\partial} \log \left(1 + \sum_{j=1}^n \frac{|z_j|^2}{|z_0|^2} \right).$$

We are neglecting a factor $\frac{i}{2}$, which would not play any significant role in this proof. In particular $(\Phi^{-1})^* \mathcal{E}^*(\vartheta_{\mathbb{C}\mathbb{P}^n}) = d\eta$, where

$$\eta = \frac{1}{2} \left(\bar{\partial} \log \left(1 + \sum_{j=1}^n \frac{|z_j|^2}{|z_0|^2} \right) - \partial \log \left(1 + \sum_{j=1}^n \frac{|z_j|^2}{|z_0|^2} \right) \right).$$

We thus have

$$\begin{aligned} P_\rho(\vartheta_{\mathbb{C}\mathbb{P}^n}) &= (T\mathbf{L}(\mathcal{S} \setminus \mathcal{S}_\rho))((\Phi^{-1})^* \vartheta_{\mathbb{C}\mathbb{P}^n}) = (T\mathbf{L}(\mathcal{S} \setminus \mathcal{S}_\rho))(d\eta) = \\ &= \partial [T\mathbf{L}(\mathcal{S} \setminus \mathcal{S}_\rho)](\eta). \end{aligned}$$

The boundary of $T\mathbf{L}(\mathcal{S} \setminus \mathcal{S}_\rho)$ is made of three portions: two live in the spheres ∂B_1 and ∂B_ρ and the third one is given by the slice of $(T\mathbf{L}\mathcal{S}_\varepsilon)\mathbf{L}(B_1 \setminus B_\rho)$ with the hypersurface $\sum_{j=1}^n \frac{|z_j|^2}{|z_0|^2} = 1$. There is no loss of generality in assuming that these slices exists.

The explicit form of η then implies that the latter portion of boundary, i.e. the slice of T with the hypersurface $\sum_{j=1}^n \frac{|z_j|^2}{|z_0|^2} = 1$, has zero action on η . We can thus write

$$P_\rho(\vartheta_{\mathbb{C}\mathbb{P}^n}) = \langle T\mathbf{L}\mathcal{S}, |z| = 1 \rangle(\eta) - \langle T\mathbf{L}\mathcal{S}, |z| = \rho \rangle(\eta).$$

Now observe the comass of η . The comasses are equivalent up to a universal constant C to the maximum modulus of the coefficients of the form. We can explicitly compute $\|\eta\|^* \leq \frac{C}{\rho}$, where ρ is the distance from the origin.

Now we focus on the sequence ρ_k chosen in step 1, for which (ii) and (4.17) hold. We thus get, independently of ρ_k ,

$$|P_{\rho_k}(\vartheta_{\mathbb{C}\mathbb{P}^n})| \leq 4K C. \quad (4.18)$$

The estimate

$$|P_\rho(\mathcal{E}^* \vartheta_{\mathbb{C}^{n+1}})| = |T_{0,\rho} \mathbf{L}(\mathcal{S} \setminus \mathcal{S}_\rho)((\Phi^{-1})^* \mathcal{E}^* \vartheta_{\mathbb{C}^{n+1}})| \leq K \quad (4.19)$$

follows easily since Φ^{-1} is length-preserving in the vertical coordinates and thus $(\mathcal{E} \circ \Phi^{-1})^*$ preserves the comass of $\vartheta_{\mathbb{C}^{n+1}}$.

Now let us consider $|P_\rho(\vartheta - \vartheta_0)|$. Thanks to the Lipschitz control from lemma 4.3.1, i.e. $|\vartheta - \vartheta_0|(\cdot) \leq \text{cdist}_{\mathbf{g}_0}(\cdot, \mathbb{C}\mathbb{P}^n \times \{0\})$, the two-form $(\Phi^{-1})^*(\vartheta -$

ϑ_0) in \mathcal{S} has comass $\leq \frac{cC}{\rho} \leq \frac{C}{\rho}$, where ρ is the distance from the origin and C is a dimensional constant (c can be assumed to be smaller than 1).

We can then decompose $\mathcal{S} = \cup_{j=0}^{\infty} A_j$, where $A_j = \mathcal{S} \cap \left(B_{\frac{1}{2^j}} \setminus B_{\frac{1}{2^{j+1}}} \right)$. As observed in remark 4.2.1 it holds $M(T \llcorner A_j) \leq K \frac{1}{2^{2j}}$. On the other hand the comass of $(\Phi^{-1})^*(\vartheta - \vartheta_0)$ in A_j is $\leq C 2^{j+1}$.

Therefore summing on all j 's we can bound

$$\begin{aligned} |P_\rho(\vartheta - \vartheta_0)| &= |(T \llcorner \mathcal{S})((\Phi^{-1})^*(\vartheta - \vartheta_0))| \leq \\ &\leq K C \sum_{j=0}^{\infty} 2^{j+1} \frac{1}{2^{2j}} = K C \sum_{j=0}^{\infty} 2^{1-j} = 4K C, \end{aligned} \quad (4.20)$$

so $|P_\rho(\vartheta - \vartheta_0)|$ is also equibounded independently of ρ .

Putting (4.18), (4.19) and (4.20) together, we obtain that $M(P_{\rho_k})$ are uniformly bounded by K times a dimensional constant C . By compactness there exists a current P in \mathcal{A} such that $P_\rho \rightharpoonup P$.

So far we were taking the mass with respect to \mathbf{g} . Since \mathbf{g} is c -close to \mathbf{g}_0 , for a small constant c , an analogous bound holds, up to doubling the constant C , for the mass of P computed with respect to \mathbf{g}_0 . This observation is needed later in section 4.4. □

Our next aim is to prove that the current P just obtained is in fact a cycle in the open set \mathcal{A} . A priori this is not clear, for in the limit $\rho \rightarrow 0$ some boundary could be created on $\mathbb{C}\mathbb{P}^n \times \{0\}$.

proof of lemma 4.3.3. Step 1. We are viewing P as a current in the open set \mathcal{A} in the manifold $\tilde{\mathbb{C}}^{n+1}$, so the same should be done for the currents $P_\rho := (\Phi^{-1})_*(T \llcorner (\mathcal{S} \setminus \mathcal{S}_\rho))$. Given a sequence $\rho_k \rightarrow 0$, we want to observe the boundaries ∂P_{ρ_k} . Up to a subsequence we may assume that ρ_k is such that $T_{0,\rho_k} \rightharpoonup T_\infty$ for a certain cone. Then the boundaries ∂P_{ρ_k} satisfy, as $k \rightarrow \infty$, by the definition (4.16) of Λ_{ρ_k} :

$$(\Lambda_{\rho_k})_*(\partial P_{\rho_k}) = -(\Phi^{-1})_* \langle T_{0,\rho_k}, |z| = 1 \rangle \rightharpoonup -(\Phi^{-1})_* \langle T_\infty, |z| = 1 \rangle. \quad (4.21)$$

Recall that we are viewing P_{ρ_k} as currents in the open set \mathcal{A} , so also $T \llcorner (\mathcal{S} \setminus \mathcal{S}_\rho)$ should be thought of as a current in the open set \mathcal{S} : this is why the only boundary comes from the slice of T with $|z| = \rho_k$.

Moreover if the sequence is chosen (and we will do so) as in step 1 of lemma 4.3.2, then $(\Lambda_{\rho_k})_*(\partial P_{\rho_k})$ have equibounded masses, since so do $\partial(T_{0,\rho_k})$ and Φ^{-1} is a diffeomorphism on ∂B_1 .

The current T_∞ has a special form: it is a $(1,1)$ -cone, so the 1-current $\langle T_\infty, |z| = 1 \rangle$ has an associated vector field that is always tangent to the Hopf fibers⁵ of S^{2n+1} .

Step 2. We want to show that P is a cycle in \mathcal{A} , i.e. that $\partial P_{\rho_k} \rightarrow 0$ as $n \rightarrow \infty$. The boundary in the limit could possibly appear on $\mathbb{C}\mathbb{P}^n \times \{0\}$ and we can exclude that as follows.

Let α be a 1-form of comass one with compact support in \mathcal{A} and let us prove that $\partial P_{\rho_k}(\alpha) \rightarrow 0$. Since \mathcal{A} is a submanifold in $\mathbb{C}\mathbb{P}^n \times \mathbb{C}^{n+1}$, we can extend α to be a form in $\mathbb{C}\mathbb{P}^n \times \mathbb{C}^{n+1}$. Let us write, using horizontal coordinates $\{t_j\}_{j=1}^{2n}$ on $\mathbb{C}\mathbb{P}^n$ and vertical ones $\{s_j\}_{j=1}^{2n+2}$ for \mathbb{C}^{n+1} , $\alpha = \alpha_h + \alpha_v$, where α_h is a form in the dt_j 's, α_v in the ds_j 's. Rewrite, viewing P_{ρ_n} as currents in $\mathbb{C}\mathbb{P}^n \times \mathbb{C}^{n+1}$,

$$\partial P_{\rho_k}(\alpha) = [(\Lambda_{\rho_k})_*(\partial P_{\rho_k})] (\Lambda_{\rho_k}^{-1})^* \alpha.$$

The map $\Lambda_{\rho_k}^{-1}$ is expressed in our coordinates by $(t_1, \dots, t_{2n}, s_1, \dots, s_n) \rightarrow (t_1, \dots, t_{2n}, \rho_k s_1, \dots, \rho_k s_{2n+2})$, therefore

$$(\Lambda_{\rho_k}^{-1})^* \alpha = \alpha_h^n + \alpha_v^n,$$

where the decomposition is as above and with $\|\alpha_h^n\|^* \approx \|\alpha_h\|^*$ and $\|\alpha_v^n\|^* \lesssim \rho_k \|\alpha_v\|^*$. The signs \approx and \lesssim mean respectively equality and inequality of the comasses up to a dimensional constant, so independently of the index n of the sequence.

As $k \rightarrow \infty$ it holds $\alpha_h^k \rightarrow \alpha_h^\infty$ in some C^ℓ -norm, where $\|\alpha_h^\infty\|^* \lesssim 1$ and α_h^∞ is a form in the dt_j 's. More precisely α_h^∞ coincides with the restriction of α_h to $\mathbb{C}\mathbb{P}^n \times \{0\}$, extended to $\mathbb{C}\mathbb{P}^n \times \mathbb{C}^{n+1}$ independently of the s_j variables. We can write

$$|[(\Lambda_{\rho_k})_*(\partial P_{\rho_k})](\alpha_h^k)| \leq |[(\Lambda_{\rho_k})_*(\partial P_{\rho_k})](\alpha_h^k - \alpha_h^\infty)| + |[(\Lambda_{\rho_k})_*(\partial P_{\rho_k})](\alpha_h^\infty)|$$

and both terms on the r.h.s. go to 0. The first, since $M((\Lambda_{\rho_k})_*(\partial P_{\rho_k}))$ are equibounded and $|\alpha_h^k - \alpha_h^\infty| \rightarrow 0$; the second because we can use (4.21) and $(\Phi^{-1})_* \partial(T_\infty)$ has zero action on a form that only has the dt_j 's components, as remarked in step 1.

⁵The Hopf fibration is defined by the projection $H : S^{2n+1} \subset \mathbb{C}^{n+1} \rightarrow \mathbb{C}\mathbb{P}^n$, $H(z_0, \dots, z_n) = [z_0, \dots, z_n]$. The Hopf fibers $H^{-1}(p)$ for $p \in \mathbb{C}\mathbb{P}^n$ are maximal circles in S^{2n+1} , namely the links of complex lines of \mathbb{C}^{n+1} with the sphere.

Moreover

$$|[(\Lambda_{\rho_k})_*(\partial P_{\rho_k})](\alpha_v^k)| \rightarrow 0,$$

because $(\Lambda_{\rho_k})_*(\partial P_{\rho_k}) = -(\Phi^{-1})_*(T_{0,\rho_k}, |z| = 1)$ have equibounded masses by the choice of ρ_k , while $\|\alpha_v^k\|^* \lesssim \rho_k \|\alpha_v\|^*$ have comasses going to 0.

Therefore no boundary appears in the limit and P is a normal cycle in \mathcal{A} . The fact that it is ϑ -positive follows easily by the fact that so are the currents P_{ρ} , as remarked in the beginning of the proof of lemma 4.3.2. □

Summarizing, we define the current P thus constructed to be the **proper transform** of the positive (1, 1)-normal cycle $T \llcorner \mathcal{S}$. P is a normal and ϑ -positive cycle in \mathcal{A} , where the semicalibration ϑ is Lipschitz (and actually smooth away from $\mathbb{C}\mathbb{P}^n \times \{0\}$). Therefore the almost monotonicity formula holds true for P . Observe that the metric \mathbf{g} on \mathcal{A} fulfils the hypothesis $\frac{1}{5}\mathbb{I} \leq \mathbf{g} \leq 5\mathbb{I}$ of proposition 9, being a perturbation of \mathbf{g}_0 , which is in turn built from the Fubini-Study metric.

4.4 Proof of the result

With the assumptions in proposition 10, we have to observe a sequence $T_{0,r_n} = (\lambda_{r_n})_*T$ as $r_n \rightarrow 0$. These currents have equibounded masses by (4.11).

Take any converging sequence $T_{0,r_n} := (\lambda_{r_n})_*T \rightharpoonup T_\infty$ for $r_n \rightarrow 0$. Take the proper transform of each T_{0,r_n} and denote it by P_n . Lemmas 4.3.2 and 4.3.3 yield that P_n is a ϑ_n -positive cycle, for a semicalibration ϑ_n in the manifold \mathcal{A} . ϑ_n is smooth away from $\mathcal{V} \times \{0\}$ and it is Lipschitz-continuous, with $|\vartheta_n - \vartheta_0| < c_n \text{dist}_{\mathbf{g}_0}(\cdot, \mathbb{C}\mathbb{P}^n \times \{0\})$. Recalling lemma 4.3.1 we can see that, since the almost complex structure J_{r_n} on \mathcal{S} fulfils $|J_{r_n} - J_0| < (Q r_n) \cdot r$ in \mathcal{S} (by dilation), then the constants c_n go to 0 as $n \rightarrow \infty$. Analogously we get that the Lipschitz constants of ϑ_n are uniformly bounded.

By lemma 4.3.2 the masses of P_n are uniformly bounded in n (with respect to \mathbf{g}_0), since so are the masses of T_{0,r_n} , $M(T_{0,r_n}) \leq K$.

So by compactness, up to a subsequence that we do not relabel, we can assume $P_n \rightharpoonup P_\infty$ as $n \rightarrow \infty$ for a normal cycle P_∞ .

Lemma 4.4.1. *P_∞ is a ϑ_0 -positive cycle; more precisely it is the proper transform of T_∞ .*

Proof. ϑ_0 -positiveness follows stright from the ϑ_n -positiveness of P_n and $|\vartheta_n - \vartheta_0| < c_n \text{dist}_{\mathbf{g}_0}(\cdot, \mathbb{C}\mathbb{P}^n \times \{0\})$, $c_n \rightarrow 0$.

Recall that $\vartheta_0 = \mathcal{E}^*(\vartheta_{\mathbb{C}\mathbb{P}^n} + \vartheta_{\mathbb{C}\mathbb{P}^{n+1}})$; we want to estimate

$$M(P_\infty \llcorner \mathcal{A}_\rho) = (P_\infty \llcorner \mathcal{A}_\rho)(\vartheta_0) = \lim_{n \rightarrow \infty} (P_n \llcorner \mathcal{A}_\rho)(\vartheta_0).$$

Write

$$(P_n \llcorner \mathcal{A}_\rho)(\vartheta_0) = (P_n \llcorner \mathcal{A}_\rho)(\mathcal{E}^* \vartheta_{\mathbb{C}\mathbb{P}^n}) + (P_n \llcorner \mathcal{A}_\rho)(\mathcal{E}^* \vartheta_{\mathbb{C}\mathbb{P}^{n+1}}). \quad (4.22)$$

Let us bound the second term on the r.h.s.

$$(P_n \llcorner \mathcal{A}_\rho)(\mathcal{E}^* \vartheta_{\mathbb{C}\mathbb{P}^{n+1}}) = (\Lambda_\rho)_*(P_n \llcorner \mathcal{A}_\rho) \left((\Lambda_r^{-1})^*(\mathcal{E}^* \vartheta_{\mathbb{C}\mathbb{P}^{n+1}}) \right).$$

The current $(\Lambda_\rho)_*(P_n \llcorner \mathcal{A}_\rho)$ is the proper transform of $T_{0, \rho r_n}$, therefore (lemma 4.3.2) $M((\Lambda_\rho)_*(P_n \llcorner \mathcal{A}_\rho)) \leq K C$ independently of n ; the form in brackets $(\Lambda_r^{-1})^*(\mathcal{E}^* \vartheta_{\mathbb{C}\mathbb{P}^{n+1}})$ has comass bounded by ρ^2 . Altogether

$$(P_n \llcorner \mathcal{A}_\rho)(\mathcal{E}^* \vartheta_{\mathbb{C}\mathbb{P}^{n+1}}) \leq K C \rho^2.$$

To bound the first term on the r.h.s. of (4.22), let P be the proper transform of T ; using that $(\Lambda_{r_n})^* \mathcal{E}^* \vartheta_{\mathbb{C}\mathbb{P}^n} = \mathcal{E}^* \vartheta_{\mathbb{C}\mathbb{P}^n}$ we can write

$$(P_n \llcorner \mathcal{A}_\rho)(\mathcal{E}^* \vartheta_{\mathbb{C}\mathbb{P}^n}) = (P \llcorner \mathcal{A}_{r_n \rho})(\mathcal{E}^* \vartheta_{\mathbb{C}\mathbb{P}^n}) \leq M(P \llcorner \mathcal{A}_{r_n \rho}) \leq M(P \llcorner \mathcal{A}_\rho),$$

which goes to 0 as $\rho \rightarrow 0$ by lemma 4.3.2. Summarizing we get that there exists a function $o_\rho(1)$ that is infinitesimal as $\rho \rightarrow 0$, such that $|(P_n \llcorner \mathcal{A}_\rho)(\vartheta_0)| \leq o_\rho(1)$ (the point is that $o_\rho(1)$ can be chosen independently of n).

Therefore also $M(P_\infty \llcorner \mathcal{A}_\rho) = \lim_{n \rightarrow \infty} (P_n \llcorner \mathcal{A}_\rho)(\vartheta_0) \leq o_\rho(1)$, which means that

$$P_\infty = \lim_{\rho \rightarrow 0} P_\infty \llcorner (\mathcal{A} \setminus \mathcal{A}_\rho). \quad (4.23)$$

Recall now that the proper transform is a diffeomorphism away from the origin, thus

$$P_\infty \llcorner (\mathcal{A} \setminus \mathcal{A}_\rho) = \lim_n (\Phi^{-1})_* T_{0, r_n} \llcorner (\mathcal{S} \setminus \mathcal{S}_\rho) = (\Phi^{-1})_* T_\infty \llcorner (\mathcal{S} \setminus \mathcal{S}_\rho),$$

which concludes, together with (4.23), the proof that P_∞ is the proper transform of $(\Phi^{-1})_* T_\infty$. □

Recalling (4.3), the previous lemma tells us that P_∞ is of a very special form. Denoting $\mathcal{V} := \left\{ \sum_{j=1}^n \frac{|z_j|^2}{|z_0|^2} < 1 \right\} \subset \mathbb{C}\mathbb{P}^n$ and, for each disk D^X in \mathcal{S} , L^X the disk such that $\Phi(L^X) = D^X$, we have

$$P_\infty(\beta) = \int_{\mathcal{V}} \left\{ \int_{L^X} \langle \beta, L^{\vec{X}} \rangle d\mathcal{L}^2 \right\} d\tau|_{\mathcal{V}}(X). \quad (4.24)$$

When we take the proper transform the density is conserved going from \mathcal{S} to $\Phi^{-1}(\mathcal{S})$, since Φ^{-1} is a diffeomorphism on \mathcal{S} (see lemma B.0.2).

We are ready to conclude the proof of proposition 10, and therefore of theorems 4.0.1 and 4.1.1.

proof of proposition 10. The points $\frac{x_m}{|x_m|}$ converge to the point $(1, 0, \dots, 0)$ in $D \cap S^{2n+1}$, where D is the disk $D = D^{[1,0,\dots,0]}$.

We want to show that any converging sequence $T_{0,r_n} := (\lambda_{r_n})_* T \rightarrow T_\infty$ is such that the cone T_∞ contains $\kappa[D]$.

Let us apply the proper transform to T_{0,r_n} and get P_n as in lemma 4.4.1. Fix n : there is a sequence $\{x_m\}$ tending to the origin of points with densities $\geq \kappa$. By lemma B.0.2 the points $p_m := (\Phi^{-1})(x_m)$ have density $\geq \kappa$ for P_n . It easily seen that it holds $p_m \rightarrow p_0 = ([1, 0, \dots, 0], 0) \in \mathbb{C}\mathbb{P}^n \times \mathbb{C}^{n+1}$.

By upper semi-continuity of the density (which follows from the almost monotonicity formula for P_n) we get that p_0 also has density $\geq \kappa$ for P_n .

Doing this for every n we get that we are dealing with a sequence of normal cycles P_n all having the point p_0 as a point of density $\geq \kappa$. We wish to prove that, being the cycles P_n positive, then the point p_0 is also of density $\geq \kappa$ for the limit P_∞ .

The cycles P_n are ϑ_n -positive so for any $\delta > 0$ it holds

$$M(P_n \llcorner B_\delta(p_0)) = (P_n \llcorner B_\delta(p_0))(\vartheta_n).$$

By weak convergence

$$\begin{aligned} M(P_\infty \llcorner B_\delta(p_0)) &= (P_\infty \llcorner B_\delta(p_0))(\vartheta_0) = \\ &= \lim_{n \rightarrow \infty} (P_n \llcorner B_\delta(p_0))(\vartheta_0). \end{aligned}$$

We can split

$$(P_n \llcorner B_\delta(p_0))(\vartheta_0) = (P_n \llcorner B_\delta(p_0))(\vartheta_0 - \vartheta_n) + (P_n \llcorner B_\delta(p_0))(\vartheta_n). \quad (4.25)$$

The semi-calibrations ϑ_n have uniform bounds on their Lipschitz constants, say $2L$. The metrics at p_0 coincide with \mathbf{g}_0 independently of n . We

can therefore use the almost monotonicity formula for P_n at p_0 (proposition 9) to get

$$(P_n \llcorner B_\delta(p_0))(\vartheta_n) = M(P_n \llcorner B_\delta(p_0)) \geq \pi(\kappa - C2L\delta)\delta^2,$$

where C is a universal constant. The forms ϑ_n fulfil $|\vartheta_n - \vartheta_0| < c_n$ in $B_\delta(p_0)$ and $c_n \rightarrow 0$ as $n \rightarrow \infty$. Therefore we can bound, from (4.25),

$$|(P_n \llcorner B_\delta(p_0))(\vartheta_0)| \geq -c_n K C + M(P_n \llcorner B_\delta(p_0)) \geq -c_n K C + \pi\kappa\delta^2 - 2CL\delta^3.$$

Since $c_n \rightarrow 0$ we can conclude

$$M(P_\infty \llcorner B_\delta(p_0)) \geq \pi\kappa\delta^2 - 2CL\delta^3 \tag{4.26}$$

independently of δ , which means that p_0 is a point of density $\geq \kappa$ for the ϑ_0 -positive cycle P_∞ .

Recall the structure of P_∞ : it is made by the holomorphic disks L^X weighted with the positive measure τ , so if y_0 has density $\geq \kappa$, then the disk $L^{[1,0,\dots,0]}$ must be weighted with a mass $\geq \kappa$, in other words the measure τ must have an atom of mass $\geq \kappa$ at y_0 .

So P_∞ is of the form $\kappa\llbracket L^{[1,0,\dots,0]} \rrbracket + \tilde{P}$, for a ϑ_0 -positive current \tilde{P} . Transforming back via Φ , T_∞ contains the disk $\kappa\llbracket D \rrbracket$, as required. □

4.5 Kiselman's counterexample revisited

We would like to provide a geometric picture of Kiselman's counterexample [36]. The blow up used in the proof turns out to be useful again. From now on, for sake of simplicity, we assume to be working in the integrable case $(\mathbb{C}^2, J_0, \omega_0)$, with coordinates $z = (z_1, z_2)$. The word positive will be used instead of ω_0 -positive.

We briefly recall the connection between plurisubharmonic functions and positive currents.

A plurisubharmonic (psh) function f is, by definition, an upper semi-continuous function whose restriction to complex lines is subharmonic. Equivalently, the Levi form $L_{ij} := \frac{\partial^2 f}{\partial z_i \partial \bar{z}_j}$, for $i, j \in \{1, 2\}$, is positive definite. This last condition automatically implies that $\frac{\partial^2 f}{\partial z_i \partial \bar{z}_j}$ are Radon measures.

For $i \in \{1, 2\}$, denote by $\partial_i : \Lambda^k \rightarrow \Lambda^{k+1}$ (respectively $\bar{\partial}_i$) the operator on forms whose action on a function f is given by $\partial_i(f) := \frac{\partial f}{\partial z_i} dz^i$ (resp.

$\partial_i(f) := \frac{\partial f}{\partial \bar{z}_i} d\bar{z}^i$. So the two-form

$$\partial\bar{\partial}f = (\partial_1 + \partial_2)(\bar{\partial}_1 + \bar{\partial}_2)f = \sum_{ij} \frac{\partial^2 f}{\partial z_i \partial \bar{z}_j} dz^i \wedge d\bar{z}^j$$

has measure coefficients and gives rise to a normal positive cycle T_f , which acts on a two-form β as follows

$$T_f(\beta) := \int_{\mathbb{C}^2} \partial\bar{\partial}f \wedge \beta.$$

Recall that $\partial^2 = \bar{\partial}^2 = 0$. Since the standard differential d equals $\partial + \bar{\partial}$, the two-form $\partial\bar{\partial}f$ is closed and T_f is easily seen to be a cycle: for any one-form α

$$\partial T_f(\alpha) := \int_{\mathbb{C}^2} \partial\bar{\partial}f \wedge d\alpha = \int_{\mathbb{C}^2} d(\partial\bar{\partial}f) \wedge \alpha = 0.$$

With this in mind, every positive cone with density ν at the vertex (assume without loss of generality that the vertex is at the origin) is representable as a plurisubharmonic function h with the following homogeneity property (see [36])

$$h(tz) = \nu \log |t| + h(z), \text{ for any } t \in \mathbb{C}, z \in \mathbb{C}^2.$$

More precisely (see [9]), denoting $\pi : \mathbb{C}^2 \rightarrow \mathbb{C}\mathbb{P}^1$ the standard projection, h is of the form $\nu \log |z| + f \circ \pi$ for some $f : \mathbb{C}\mathbb{P}^1 \rightarrow \mathbb{R}$.

Let us see a concrete example, where we translate the question from \mathbb{C}^2 to $\tilde{\mathbb{C}}^2$ using the algebraic blow up. Let us fix notations first.

We send the point $0 \neq (z_1, z_2) \in \mathbb{C}^2$ to the point $([z_1, z_2], z_1, z_2) \in \tilde{\mathbb{C}}^2 \subset \mathbb{C}\mathbb{P}^1 \times \mathbb{C}^2$. Using the chart $\frac{z_1}{z_2}$ on $\mathbb{C}\mathbb{P}^1$, we can identify $([z_1, z_2], z_1, z_2)$ with $(\frac{z_1}{z_2}, \frac{z_1}{z_2} z_2, z_2) = (a, \lambda a, \lambda) \in \mathbb{C} \times \mathbb{C}^2$ with $a, \lambda \in \mathbb{C}$. Therefore we can locally identify the complex line bundle $\tilde{\mathbb{C}}^2$ with $\mathbb{C} \times \mathbb{C}^2$ with coordinates (a, λ) . The holomorphic planes through the origin are sent to the holomorphic planes $\{p\} \times \mathbb{C}^2$. The image of a sphere of radius r in \mathbb{C}^2 is, after the blow-up, the hypersurface $|\lambda| = \frac{r}{\sqrt{1+|a|^2}}$.

A positive cone in \mathbb{C}^2 , with density ν at the vertex (placed at the origin) is given by assigning a positive Radon measure on $\mathbb{C}\mathbb{P}^1$, having total mass ν . Let us blow-up the origin of \mathbb{C}^2 and move to $\mathbb{C} \times \mathbb{C}^2$. We have a measure μ on the first \mathbb{C} -factor, i.e. a measure on the set of ‘‘vertical’’ holomorphic planes. Consider the psh function $\nu \log |\lambda| + f(a)$ (with $\nu = |\mu|$), where

$f(a) = \int_{\mathbb{C}} \log |\zeta - a| d\mu(\zeta)$, i.e. f is the convolution of μ with the fundamental solution of the Laplace operator in \mathbb{C} . In particular, $\Delta f = \mu$.

The current $\partial\bar{\partial}(\nu \log |\lambda| + f(a))$ is the sum of the current associated to the 2-surface $\mathbb{C} \times \{0\}$ with multiplicity ν and the current associated to integration on the vertical 2-planes, weighted with μ .⁶

To fix ideas, let $\nu = 1$. Let us assume that, for $r_1 < R_2$, in the domain $\frac{R_2}{\sqrt{1+|a|^2}} < |\lambda| < \frac{R_1}{\sqrt{1+|a|^2}}$ the current is very close to the plane $\nu[\{p_1\} \times \mathbb{C}]$ and for $\frac{r_2}{\sqrt{1+|a|^2}} < |\lambda| < \frac{r_1}{\sqrt{1+|a|^2}}$ it is very close to the plane $\nu[\{p_2\} \times \mathbb{C}]$, where $\{p_1\} \times \mathbb{C}$ and $\{p_2\} \times \mathbb{C}$ are distinct “vertical” holomorphic planes. To fix ideas, let f, g be such that Δf and Δg are positive measures of total mass 1, very close to Dirac deltas placed respectively in correspondence of the points p_1 and p_2 .

Question: how can we extend the current across the intermediate domain $\frac{r_1}{\sqrt{1+|a|^2}} < |\lambda| < \frac{R_2}{\sqrt{1+|a|^2}}$ in such a way that it is globally positive and boundaryless?

Consider the currents T_1 and T_2 representable as integration of the actions of the vertical planes with weights $c_1\Delta f$ and $c_2\Delta g$, with $c_1 > c_2 > 1$. In terms of psh functions, $T_1 = c_1\partial\bar{\partial}f$ and $T_2 = c_2\partial\bar{\partial}g$. Consider the function

$$E(a, \lambda) := c_2g(a) - c_1f(a) - (c_1 - c_2) \log |\lambda|.$$

Its level sets $E_\eta = \{E = \eta\}$ are the hypersurfaces $|\lambda| = e^{\frac{c_2g - c_1f - \eta}{c_1 - c_2}}$. Choose a positive value of η , large enough in modulus, so to ensure that the corresponding level set E_η is contained in the intermediate domain $\frac{r_1}{\sqrt{1+|a|^2}} < |\lambda| < \frac{R_2}{\sqrt{1+|a|^2}}$.

Set the current $\chi_{\{E \geq \eta\}}T_1 + \chi_{\{E \leq \eta\}}T_2$, which equals T_1 above E_η and T_2 below E_η . Such a current develops a boundary on E_η given by the slices of T_1 and T_2 with the level set E_η . Precisely the boundary is given by the 1-current of integration along the “vertical” circles $E_\eta \cap (\{a\} \times \mathbb{C})$ weighted with $-c_1\Delta f + c_2\Delta g$.

Claim: there exists a positive 2-current, supported in E_η , whose boundary is the same as the boundary just described with opposite sign.

This can be seen explicitly as follows. Let us consider the one form $\iota_{\nabla E}\omega_0$. Its differential is given, through Cartan’s formula, by $d(\iota_{\nabla E}\omega_0) = \mathcal{L}_{\nabla E}\omega_0$, the Lie derivative of ω_0 along the gradient field.

⁶By going back to the coordinates $z_1 = a\lambda, z_2 = \lambda$, we can recover the psh function on \mathbb{C}^2 : for this purpose it is convenient to rewrite $\nu \log |\lambda| + f(a) = \nu \log |\lambda| + \nu \log \sqrt{1 + |a|^2} - \nu \log \sqrt{1 + |a|^2} + f(a)$, so that the inverse transform of $\nu \log |\lambda| + \nu \log \sqrt{1 + |a|^2}$ is $\nu \log |z|$.

It holds, as we are about to see, on the set $\{\lambda \neq 0\}$,

$$\mathcal{L}_{\nabla E}\omega_0 = (c_1\Delta f - c_2\Delta g) \left(\frac{i}{2}da \wedge d\bar{a} \right). \quad (4.27)$$

Let us compute this Lie derivative. For the sake of notation, only for this computation we take coordinates x_1, x_2, x_3, x_4 so that $a = x_1 + ix_2$ and $\lambda = x_3 + ix_4 = 0$ and denote by ∂_j the derivations w.r.t. x_j . So we write $\omega_0 = dx^1 \wedge dx^2 + dx^3 \wedge dx^4$ and $\nabla E = (\partial_i E)\partial_i$.

$$\begin{aligned} \mathcal{L}_{\nabla E}dx^1 \wedge dx^2 &= (\mathcal{L}_{\nabla E}dx^1) \wedge dx^2 + dx^1 \wedge (\mathcal{L}_{\nabla E}dx^2) = \\ &= (d\mathcal{L}_{\nabla E}x^1) \wedge dx^2 + dx^1 \wedge (d\mathcal{L}_{\nabla E}x^2) = (d(\partial_1 E)) \wedge dx^2 + dx^1 \wedge (d(\partial_2 E)) \\ &= (\partial_k \partial_1 E)dx^k \wedge dx^2 + (\partial_k \partial_2 E)dx^1 \wedge dx^k = (\partial_1 \partial_1 E + \partial_2 \partial_2 E)dx^1 \wedge dx^2. \end{aligned}$$

In the last equality we used the specific form of E . An analogous computation yields

$$\mathcal{L}_{\nabla E}dx^3 \wedge dx^4 = (\partial_3 \partial_3 E + \partial_4 \partial_4 E)dx^3 \wedge dx^4.$$

Away from $\{\lambda = x_3 + ix_4 = 0\}$, the Laplacian $(\partial_3 \partial_3 E + \partial_4 \partial_4 E) = \Delta(\log \lambda)$ vanishes, so (4.27) is proven.

If we take, in the boundaryless 3-surface E_η , the 2-current corresponding in duality to the one-form $\iota_{\nabla \eta}\omega_0$, this is positive and its boundary is the 1-current dual to $d(\iota_{\nabla E}\omega_0)$, i.e. its boundary erases exactly that of $\chi_{\{E \geq \eta\}}T_1 + \chi_{\{E \leq \eta\}}T_2$. So the claim is proved: this current fills the gap between T_1 and T_2 along E_η .

This operation seems a bit magical, but is nothing else than the geometric picture corresponding to the operation of taking the supremum of the psh functions $c_1 f$ and $c_2 g - \eta$. Since psh functions are closed under this operation, the current $\partial\bar{\partial}(\sup\{c_1 f, c_2 g - \eta\})$ is guaranteed to be positive and boundaryless: E_η is the set where the two functions are equal and the operation of taking the sup amounts to filling the gap along E_η with the current $\iota_{\nabla E}\omega_0$.

Remarks on the counterexample [36]. The construction described in this section is exactly what Kiselman does, although the geometric picture in [36] is a bit hidden by the fact that everything is expressed in terms of psh functions. The current he constructs is made by iterating the construction: with suitable choices of the parameters involved he alternates currents defined in suitable domains $\frac{r_2}{\sqrt{1+|a|^2}} < |\lambda| < \frac{r_1}{\sqrt{1+|a|^2}}$ and ensures that the measures that we called Δf and Δg have different limits.

The failure of uniqueness of tangent cone for a positive $(1, 1)$ cycle must happen at a point x_0 where there exists $\delta > 0$ so that the Lelong number ν fulfils $\nu(x_0) \geq \nu(x) + \delta$ for all points x in a neighbourhood of x_0 . This fact follows, in the complex setting, from Siu's result [56], while for an almost complex setting it is yielded by theorem 4.0.1.

Indeed, the current constructed in [36] has the property that the point x_0 where it fails to have a unique tangent cone is an isolated point of strictly positive density. Therefore the proof given in this chapter for theorem 4.0.1 fails in that case.

We can make a few more comments on the “shape” of the current in [36]. It follows from the discussion in this section, and with reference to the notations used before, that the current $\chi_{\{E \geq \eta\}} T_1 + \chi_{\{E \leq \eta\}} T_2$ is perfectly “vertical”.

If we observe the slices of the current $\partial\bar{\partial}(\sup\{c_1 f, c_2 g - \eta\})$ with “vertical” holomorphic planes, we get zero contribution to the slicing for $\chi_{\{E \geq \eta\}} T_1 + \chi_{\{E \leq \eta\}} T_2$, since the current is perfectly vertical there. As for the current supported in E_η , dual to $\iota_{\nabla E} \omega_0$, we get indeed a positive contribution to the slicing, but the amount is only $\frac{c_1 - c_2}{\lambda}$, which can be made very small if the parameters are suitably chosen.

Considerations based on slicing theory tell us that slicing the algebraic blow up $(\Phi^{-1})_* T_{0,r_n}$ of a positive $(1, 1)$ current T (dilated around x_0 of a factor r_n) must lead to slices of finite mass for almost all vertical planes; moreover the slices of $(\Phi^{-1})_* T_{0,r_n}$ should tend to zero as $r_n \rightarrow 0$. It follows then that this can only happen if $(\Phi^{-1})_* T_{0,r_n}$ is “mostly vertical”, as described before. Then we get a heuristic argument that forces the “shape” of a positive $(1, 1)$ current to be just like the one exhibited in [36], if it has to have a non-unique tangent cone.

Appendix A

Almost monotonicity formula

The following almost-monotonicity formula for positive or semi-calibrated cycles is proved in [47], Proposition 1, for a C^1 semi-calibration: the same proof works as well for a form with Lipschitz-continuous coefficients (this is needed in chapter 4), so we only give the statement.

Let the ball of radius 2 in \mathbb{R}^d be endowed with a metric g and a two-form ω such that both g and ω have Lipschitz-continuous coefficients (with respect to the standard distance) and ω has unit comass for g . The metric g is represented by a matrix and we further assume that $\frac{1}{5}\mathbb{I} \leq g \leq 5\mathbb{I}$, where \mathbb{I} is the identity matrix. So g is a Lipschitz perturbation of the flat metric.

Let T be a ω -positive normal cycle. Then we have a 2-vector field $\vec{T}(x)$, of unit mass with respect to g . This means that for $\|T\|$ -a.a. x , $\vec{T}(x) = \sum_{k=1}^{N(x)} \lambda_k(x) \vec{T}_k(x)$, a convex combination of $\omega(x)$ -calibrated unit simple 2-vectors. The mass refers pointwise to the metric g_x .

Proposition 11. *In the previous hypothesis, there exists $r_0 > 0$ and $C > 0$, depending only on the Lipschitz constants of g and ω such that, given an arbitrary point $x_0 \in B_1(0)$, the following holds.*

Denote by $B_r(x_0)$ (respectively $B_s(x_0)$) the ball around x_0 of radius r (respectively s) with respect to the metric g_{x_0} ; let $|\cdot|$ be the distance for g_{x_0} and $|\cdot|_g$ the mass-norm with respect to g . Let $\frac{\partial}{\partial r}$ be the unit radial vector field with respect to x_0 and g_{x_0} .

For any $0 < s < r < r_0$, we have

$$\begin{aligned} & \frac{e^{Cr} + Cr}{r^2} (T \llcorner B_r(x_0))(\omega) - \frac{e^{Cs} + Cs}{s^2} (T \llcorner B_s(x_0))(\omega) \\ & \geq \int_{B_r \setminus B_s(x_0)} \frac{1}{|x - x_0|^2} \sum_{k=1}^{N(x)} \lambda_k(x) \left| \vec{T}_k(x) \wedge \frac{\partial}{\partial r} \right|_{g(x)}^2 d\|T\| \end{aligned} \tag{A.1}$$

and

$$\begin{aligned}
& \frac{e^{C_r} - C_r}{r^2} (T \llcorner B_r(x_0))(\omega) - \frac{e^{C_s} - C_s}{s^2} (T \llcorner B_s(x_0))(\omega) \\
& \leq \int_{B_r \setminus B_s(x_0)} \frac{1}{|x - x_0|^2} \sum_{k=1}^{N(x)} \lambda_k(x) \left| \vec{T}_k(x) \wedge \frac{\partial}{\partial r} \right|_{g(x)}^2 d\|T\|. \tag{A.2}
\end{aligned}$$

Appendix B

Behaviour under diffeomorphisms

The following two lemmas are used in chapter 4 when pushing forward a positive cycle under a diffeomorphism.

Lemma B.0.1. *[the pushforward of a $(1, 1)$ -current via a pseudoholomorphic diffeomorphism is $(1, 1)$]*

Let C be a normal positive $(1, 1)$ -current in an open set $U \subset \mathbb{R}^{2N}$, endowed with an almost complex structure J_1 and a compatible metric g_1 (so the associated two-form is uniquely determined, but we will not need it). Let $f : U \rightarrow \mathbb{R}^{2N}$ be a smooth pseudoholomorphic diffeomorphism, where \mathbb{R}^{2N} is endowed with an almost complex structure J_2 and a compatible metric g_2 . Then f_*C is a positive $(1, 1)$ -normal current in for $(\mathbb{R}^{2N}, J_2, g_2)$.

proof of lemma B.0.1. We are going to use the characterization in (4.1). The current C is represented by a couple (μ_C, \vec{C}) , where μ_C is a Radon measure and \vec{C} is a unit 2-vector field, well defined μ_C -a.e. The $(1, 1)$ condition can be expressed by the fact that $\vec{C} = \sum_{j=1}^M \lambda_j \vec{C}_j$, with $\sum_{j=1}^M \lambda_j = 1$, $\lambda_j \geq 0$ and \vec{C}_j are unit simple J_1 -invariant.

The push-forward f_*C can be represented by the Radon measure $f_*\mu_C$ and the 2-vector field (defined $f_*\mu_C$ -a.e.) $f_*\vec{C}$, the latter is however not of unit mass. Denoting by $\|\cdot\|$ the mass norm on 2-vectors with respect to g_2 , we rewrite it as

$$\begin{aligned} f_*\vec{C} &= \sum_{j=1}^M \lambda_j f_*\vec{C}_j = \sum_{j=1}^M \lambda_j \cdot \|f_*\vec{C}_j\| \frac{f_*\vec{C}_j}{\|f_*\vec{C}_j\|} = \\ &= \left(\sum_{j=1}^M \lambda_j \cdot \|f_*\vec{C}_j\| \right) \sum_{j=1}^M \frac{\lambda_j \cdot \|f_*\vec{C}_j\|}{\left(\sum_{j=1}^M \lambda_j \cdot \|f_*\vec{C}_j\| \right)} \frac{f_*\vec{C}_j}{\|f_*\vec{C}_j\|}, \end{aligned}$$

where each simple 2-vector $\frac{f_*\vec{C}_j}{\|f_*\vec{C}_j\|}$ is of unit mass and J_2 -invariant (by the hypothesis on f).

We can then represent f_*C by the Radon measure

$$\left(\sum_{j=1}^M \lambda_j \cdot \|f_*\vec{C}_j\| \right) f_*\mu_C$$

and the 2-vector field

$$\sum_{j=1}^M \frac{\lambda_j \cdot \|f_*\vec{C}_j\|}{\left(\sum_{j=1}^M \lambda_j \cdot \|f_*\vec{C}_j\| \right)} \frac{f_*\vec{C}_j}{\|f_*\vec{C}_j\|},$$

that is a convex combination of unit simple J_2 -holomorphic 2-vectors. \square

Lemma B.0.2. *[the density is preserved]*

Let U, V be open sets in \mathbb{R}^{2n+2} , ω be a calibration in U , T be a normal ω -positive 2-cycle in U , $f : U \rightarrow V$ be a diffeomorphism. Be $\nu(p) \geq 0$ the density of T at $p \in U$. Then the current f_*T has 2-density equal to $\nu(p)$ at the point $f(p) \in V$.

proof of lemma B.0.2. Up to translations, which do not affect densities, we may assume $p = f(p) = 0$, the origin of \mathbb{R}^{2n+2} . We use coordinates $q = (q_1, q_2, \dots, q_{2n+2})$.

Step 1. Assume that f is linear. Choose any sequence of radii $R_n \downarrow 0$ and dilate the current f_*T around 0 with the chosen factors, i.e. observe the sequence:

$$\left(\frac{Id}{|R_n|} \right)_* (f_*T) = \left(\frac{Id}{|R_n|} \circ f \right)_* T.$$

By the linearity of f this is the same as

$$\left(f \circ \frac{Id}{|R_n|} \right)_* T = f_* \left(\frac{Id}{|R_n|} \right)_* T.$$

The assumptions yield a subsequence R_{n_j} such that $\left(\frac{Id}{|R_{n_j}|} \right)_* T \rightarrow T_\infty$ for a cone T_∞ , whose density at the vertex is $\nu(0)$. So

$$f_* \left(\frac{Id}{|R_{n_j}|} \right)_* T \rightarrow f_*T_\infty.$$

Recall that T_∞ is represented by a positive Radon measure on the 2-planes, with total mass $\nu(0)$. The linearity of f gives that f_*T_∞ is still a cone with the same density $\nu(0)$ at the vertex, so we have found a subsequence R_{n_j} such that $\left(\frac{Id}{|R_{n_j}|}\right)_* (f_*T)$ weakly converges to a cone with density $\nu(0)$. Since the sequence R_n was arbitrary, we get in particular that f_*T has 2-density equal to $\nu(0)$ at the point $f(0) = 0$.

Step 2. For a general f , write $f(q) = Df(0) \cdot q + o(|q|)$.

As before, we have to observe $\left(\frac{Id}{|R_n|}\right)_* (f_*T)$. We show that this sequence has the same limiting behaviour as $\left(\frac{Id}{|R_n|}\right)_* ((Df(0) \cdot q)_*T)$, for which *Step 1* applies.

We estimate the difference of the actions on a two-form β supported in the unit ball B_1 :

$$\begin{aligned} & \left(\frac{Id}{|R_n|}\right)_* [f_*T - (Df(0) \cdot q)_*T] (\beta) = \\ & = T \left(f^* \left(\frac{Id}{|R_n|}\right)^* \beta - (Df(0) \cdot q)^* \left(\frac{Id}{|R_n|}\right)^* \beta \right). \end{aligned}$$

Writing explicitly $\beta = \sum_I \beta_I dq^I$, where $dq^I = dq^i \wedge dq^j$ for $i \neq j \in \{1, 2, \dots, 2n+2\}$, the difference in brackets reads¹

$$\sum_I \frac{\beta_I \circ \frac{Id}{|R_n|} \circ f - \beta_I \circ \frac{Id}{|R_n|} \circ (Df(0) \cdot q)}{R_n^2} df^I.$$

This form is supported, for n large enough, in a ball of radius $\leq \frac{1}{2|Df(0)|} R_n$ around 0. Moreover, for each I , we can estimate from above, for n large enough:

$$\begin{aligned} |df^I| & \left| \frac{\beta_I \circ \frac{Id}{|R_n|} \circ f - \beta_I \circ \frac{Id}{|R_n|} \circ (Df(0) \cdot q)}{R_n^2} \right| \leq \\ & \leq \frac{\|f\|_{C^1(B_1)} \|\beta_i\|_{C^1(B_1)}}{R_n^3} \cdot |o(|q|)| \leq \frac{|o(1)|}{R_n^2}, \end{aligned}$$

for a function $o(1)$, infinitesimal as $n \rightarrow \infty$, depending on β and $\|f\|_{C^2}$. Using monotonicity, we get a constant $K > 0$, depending on $\nu(0)$ and $\|f\|_{C^1}$,

¹Writing $f = (f^1, f^2, \dots, f^{2n+2})$ and $I = (i, j)$ the notation df^I stands for $d(f^i) \wedge d(f^j)$, as in [28] (page 120).

such that $M\left(T\mathbb{L}B_{\frac{1}{2|Df(0)|}R_n}\right) \leq KR_n^2$ for n large enough. These estimates imply

$$T\left(f^*\left(\frac{Id}{|R_n|}\right)^*\beta - (Df(0) \cdot q)^*\left(\frac{Id}{|R_n|}\right)^*\beta\right) \rightarrow 0 \text{ as } n \rightarrow \infty,$$

so the limiting behaviour of $\left(\frac{Id}{|R_n|}\right)_*(f_*T)$ must be the same as that of $\left(\frac{Id}{|R_n|}\right)_*((Df(0) \cdot q)_*T)$. In particular the density of f_*T at the point $f(0) = 0$ is $\nu(0)$.

□

Bibliography

- [1] Alexander, H. *Holomorphic chains and the support hypothesis conjecture* J. Amer. Math. Soc. 10 (1997), no. 1, 123–138.
- [2] Almgren, Jr., Frederick J. *Almgren's big regularity paper*, World Scientific Monograph Series in Mathematics, 1, Q -valued functions minimizing Dirichlet's integral and the regularity of area-minimizing rectifiable currents up to codimension 2, With a preface by Jean E. Taylor and Vladimir Scheffer, World Scientific Publishing Co. Inc., River Edge, NJ, 2000, xvi+955.
- [3] Aronszajn, N. *A unique continuation theorem for solutions of elliptic partial differential equations or inequalities of second order*, J. Math. Pures Appl. (9) Journal de Mathématiques Pures et Appliquées. Neuvième Série, 36, 1957, 235–249.
- [4] Bellettini, Costante and Rivière, Tristan *The regularity of Special Legendrian integral cycles*, to appear in Ann. Sc. Norm. Sup. Pisa Cl. Sci.
- [5] Bellettini, Costante *Almost complex structures and calibrated integral cycles in contact 5-manifolds*, preprint 2010.
- [6] Bellettini, Costante *Tangent cones to positive $(1, 1)$ De Rham currents*, preprint 2011.
- [7] Berger, M. *Quelques problèmes de géométrie riemannienne ou deux variations sur les espaces symétriques compacts de rang un*, Enseignement Math. (2), 16, (1970), 73-96.
- [8] Blair, David E. *Riemannian geometry of contact and symplectic manifolds*, Progress in Mathematics, 203, Birkhäuser Boston Inc., Boston, MA, 2002, xii+260.
- [9] Blel, M. *Sur le cône tangent à un courant positif fermé* J. Math. Pures Appl. (9) 72 (1993), no. 6, 517 - 536

- [10] Blel, Mongi and Demailly, Jean-Pierre and Mouzali, Mokhtar, *Sur l'existence du cône tangent à un courant positif fermé*, Ark. Mat. 28 (1990), 2, 231-248.
- [11] Bombieri, E.; De Giorgi, E.; Giusti, E. *Minimal cones and the Bernstein problem* Invent. Math. 7 1969 243–268.
- [12] Chang, Sheldon Xu-Dong *Two-dimensional area minimizing integral currents are classical minimal surfaces*, J. Amer. Math. Soc., Journal of the American Mathematical Society, 1, 1988, 4, 699–778.
- [13] Conti, Diego and Salamon, Simon *Generalized Killing spinors in dimension 5*, Trans. Amer. Math. Soc., 359, 11, 5319–5343, 2007.
- [14] Dao Čong Thi *Minimal real currents on compact Riemannian manifolds*, Izv. Akad. Nauk SSSR Ser. Mat., 41 (1977) 4, 853-867.
- [15] De Lellis, Camillo and Spadaro, Emanuele *Q-Valued functions revisited*, to appear in Memoirs of the AMS.
- [16] De Lellis, Camillo and Spadaro, Emanuele *Higher Integrability and Approximation of Minimal Currents* Preprint.
- [17] De Giorgi, Ennio *Su una teoria generale della misura $(r - 1)$ -dimensionale in uno spazio ad r dimensioni* Ann. Mat. Pura Appl. (4) 36 1954 191–213.
- [18] De Giorgi, Ennio *Nuovi teoremi relativi alle misure $(r - 1)$ -dimensionali in uno spazio ad r dimensioni (Italian)* Ricerche Mat. 4 (1955), 95-113.
- [19] De Rham, G. *On the area of complex manifolds* Global Analysis (Papers in Honor of K. Kodaira), 141-148 Univ. Tokyo Press (1969)
- [20] Demailly, Jean-Pierre *Nombres de Lelong généralisés, théorèmes d'intégralité et d'analyticité*, Acta Math., Acta Mathematica, 159 (1987), 3-4, 153–169.
- [21] Donaldson S.K. and Thomas R.P., *Gauge Theory in higher dimensions* in " The geometric Universe" (Oxford, 1996), Oxford Univ. Press, 1998, 31-47.
- [22] Duzaar, Frank and Steffen, Klaus *λ minimizing currents*, Manuscripta Math. 80, (1993), 4, 403-447.

- [23] Eliashberg, Yakov *Symplectic geometry of plurisubharmonic functions (English summary)*, with notes by Miguel Abreu, Gauge theory and symplectic geometry (Montreal, PQ, 1995), 49-67.
- [24] Evans, Lawrence C. and Gariepy, Ronald F. *Measure theory and fine properties of functions*, Studies in Advanced Mathematics, CRC Press, Boca Raton, FL, 1992, viii+268.
- [25] Federer, Herbert *Geometric measure theory*, Die Grundlehren der mathematischen Wissenschaften, Band 153, Springer-Verlag New York Inc., New York, 1969, xiv+676.
- [26] Federer, Herbert *Some theorems on integral currents*, Trans. Amer. Math. Soc., 117, 1965, 43-67.
- [27] Federer, Herbert; Fleming, Wendell H. *Normal and integral currents* Ann. of Math. (2) 72 1960 458-520.
- [28] Giaquinta, Mariano and Modica, Giuseppe and Souček, Jiří *Cartesian currents in the calculus of variations. I*, Ergebnisse der Mathematik und ihrer Grenzgebiete. 3. Folge. A Series of Modern Surveys in Mathematics [Results in Mathematics and Related Areas. 3rd Series. A Series of Modern Surveys in Mathematics], 37, Cartesian currents, Springer-Verlag, Berlin, 1998, xxiv+711.
- [29] Gilbarg, David and Trudinger, Neil S. *Elliptic partial differential equations of second order*, Classics in Mathematics, Reprint of the 1998 edition, Springer-Verlag, Berlin, 2001, xiv+517.
- [30] Harvey, Reese; Lawson, H. Blaine, Jr., *Calibrated geometries*, Acta Math. 148 (1982), 47-157.
- [31] Harvey, Reese and Lawson, H. Blaine Jr. *Duality of positive currents and plurisubharmonic functions in calibrated geometry*, Amer. J. Math. 131 no. 5 (2009), 1211-1240.
- [32] Harvey, Reese; Shiffman, Bernard *A characterization of holomorphic chains* Ann. of Math. (2) 99 (1974), 553-587.
- [33] Haskins, Mark *Special Lagrangian cones*, Amer. J. Math., American Journal of Mathematics, 126, 2004, 4, 845-871.
- [34] Joyce, Dominic D. *Riemannian holonomy groups and calibrated geometry*, Oxford Graduate Texts in Mathematics, 12, Oxford University Press, Oxford, 2007, x+303.

- [35] King, James R. *The currents defined by analytic varieties* Acta Math. 127 (1971), no. 3-4, 185–220.
- [36] Kiselman, Christer O. *Tangents of plurisubharmonic functions* International Symposium in Memory of Hua Loo Keng, Vol. II (Beijing, 1988), 157-167, Springer, Berlin
- [37] Kiselman, Christer O. *Densité des fonctions plurisousharmoniques*, Bull. Soc. Math. France, Bulletin de la Société Mathématique de France, 107 (1979), 3, 295–304.
- [38] Lawlor, Gary *The angle criterion*, Invent. Math., 95 1989, 2, 437-446.
- [39] Lelong, P. *Fonctions plurisousharmoniques et formes différentielles positives*, Gordon & Breach, Paris (1968), ix+79.
- [40] Lelong, Pierre *Sur la structure des courants positifs fermés*, Séminaire Pierre Lelong (Analyse) (année 1975/76), 136–156. Lecture Notes in Math., Vol. 578, Springer, Berlin, (1977).
- [41] McDuff, Dusa and Salamon Dietmar *Introduction to symplectic topology*, Oxford Mathematical Monographs, 2, The Clarendon Press Oxford University Press, New York, 1998, x+486.
- [42] Micallef, Mario J. and White, Brian *The structure of branch points in minimal surfaces and in pseudoholomorphic curves*, Ann. of Math. (2) 141 (1995), no. 1, 35–85.
- [43] Morgan, Frank, *Geometric measure theory*, Fourth edition, A beginner's guide, Elsevier/Academic Press, Amsterdam, 2009, viii+249.
- [44] Morrey, Charles B. Jr., *Multiple integrals in the calculus of variations*, Die Grundlehren der mathematischen Wissenschaften, Band 130, Springer-Verlag New York, Inc., New York, 1966, ix+506.
- [45] Nance (Mackenzie), Dana *Sufficient conditions for a pair of n -planes to be area-minimizing*, Math. Ann., 279, 1987, 1, 161-164,
- [46] Plateau J. *Statique Expérimentale et Théorique des Liquides Sournis aux seules forces moléculaires*, Gauthier-Villars, Paris (1873).
- [47] Pumberger, David and Rivière, Tristan *Uniqueness of tangent cones for semi-calibrated 2-cycles*, Duke Math. J., Duke Mathematical Journal, 152 (2010), no. 3, 441–480.

- [48] Reckziegel, Helmut *Horizontal lifts of isometric immersions into the bundle space of a pseudo-Riemannian submersion*, Global differential geometry and global analysis 1984 (Berlin, 1984), 264–279, Lecture Notes in Math., 1156, Springer, Berlin, 1985.
- [49] Rivière, Tristan, *private communication*.
- [50] Rivière, Tristan; Tian, Gang *The singular set of J -holomorphic maps into projective algebraic varieties*, J. Reine Angew. Math. 570 (2004), 47–87. 58J45
- [51] Rivière, Tristan and Tian, Gang *The singular set of 1-1 integral currents*, Ann. of Math. (2), Annals of Mathematics. Second Series, 169, 2009, 3, 741–794.
- [52] Sacks, J. and Uhlenbeck, K. *The existence of minimal immersions of 2-spheres*, Ann. of Math. (2), Annals of Mathematics. Second Series, 113, (1981), 1, 1-24.
- [53] Simon, Leon *Lectures on geometric measure theory*, Proceedings of the Centre for Mathematical Analysis, Australian National University, 3, Australian National University Centre for Mathematical Analysis, Canberra, 1983, vii+272.
- [54] Simon, Leon *Asymptotics for a class of nonlinear evolution equations, with applications to geometric problems*, Ann. of Math. (2), Annals of Mathematics. Second Series, 118 (1983), 3, 525-571.
- [55] Simons, James *Minimal varieties in riemannian manifolds*, Ann. of Math. (2), Annals of Mathematics. Second Series, 88, 1968, 62–105.
- [56] Siu, Yum Tong *Analyticity of sets associated to Lelong numbers and the extension of closed positive currents* Invent. Math. 27 (1974), 53-156.
- [57] Strominger, Andrew and Yau, Shing-Tung and Zaslow, Eric *Mirror symmetry is T-duality*, Nuclear Phys. B 479 (1996), 243-259.
- [58] Taubes, Clifford Henry, "SW \Rightarrow Gr: from the Seiberg-Witten equations to pseudo-holomorphic curves". *Seiberg Witten and Gromov invariants for symplectic 4-manifolds*. , 1–102, First Int. Press Lect. Ser., 2, Int. Press, Somerville, MA, 2000.
- [59] Tian, Gang *Gauge theory and calibrated geometry. I*, Ann. of Math. (2), Annals of Mathematics. Second Series, 151, 2000, 1, 193–268.

- [60] Tian, Gang *Elliptic Yang-Mills equation*, Proc. Natl. Acad. Sci. USA, Proceedings of the National Academy of Sciences of the United States of America, 99, (2002), 24, 15281-15286.
- [61] Tomassini, Adriano and Vezzoni, Luigi *Contact Calabi-Yau manifolds and Special Legendrian submanifolds*, Osaka J. Math., 45, 127–147, 2008.
- [62] White, Brian *Tangent cones to two-dimensional area-minimizing integral currents are unique*, Duke Math. J., Duke Mathematical Journal, 50, 1983, 1, 143–160.
- [63] Wirtinger, W. *Eine Determinantenidentität und ihre Anwendung auf analytische Gebilde in Euklidischer und Hermitescher Massbestimmung*, Monatsh. Math. Phys. 44, 1936 1, 343-365.

Curriculum Vitae

General information	<ul style="list-style-type: none">• born on 08/06/1983 in Avellino (Italy)• tel.: (+41) (0)762012503• home address: Sandacker 20, 8052 Zürich (Switzerland)
Current employment	<ul style="list-style-type: none">• Assistant at the Mathematics Department of ETH (Swiss Federal Institute of Technology) in Zürich.
Education	<ul style="list-style-type: none">• October 2006 - present: PhD student in Mathematics at ETH (Swiss Federal Institute of Technology) in Zürich. Advisor: Prof. Tristan Rivière.• July 2007: Masters diploma in mathematics at Scuola Normale Superiore of Pisa (Italy), grade: 70/70 cum laude. Advisor: Prof. Luigi Ambrosio.• July 2006: Masters degrees in mathematics, University of Pisa, grade: 110/110 cum laude.• October 2004: 1st level diploma in mathematics at Scuola Normale Superiore of Pisa.• July 2004: Bachelor degrees in mathematics, University of Pisa, grade: 110/110 cum laude.
Research interests	Geometric Analysis, Geometric Measure theory, Calibrated geometries, Elliptic PDEs.
Languages	<ul style="list-style-type: none">• Italian (primary)• English (fluent)• French (good)• German (good)

**Teaching
experience**

Undergraduate classes (at ETH)

- Fall 2007/2008: **Analysis 1** (for Engineers), exercise classes.
- Spring 2007/2008: **Functional Analysis**, exercise classes.
- Fall 2008/2009: **Partial Differential Equations** (for Chemistry), coordination of the exercise classes.
- Spring 2008/2009: **Measure Theory and Integration**, coordination of the exercise classes.
- Fall 2010/2011: **Analysis 1** (for Information Scientists), coordination of the exercise classes.
- Spring 2010/2011: **Analysis 2** (for Information Scientists), coordination of the exercise classes.

Graduate classes (at ETH)

- Spring 2009/2010: **Regularity questions in calibrated geometry.**

**Publications
and
Preprints**

- with T. Rivière: *The regularity of Special Legendrian integral cycles*, accepted paper (2010): **Ann. Sc. Norm. Sup. Pisa Cl. Sci.**
- *Almost complex structures and calibrated integral cycles in contact 5-manifolds*, preprint 2010.
- *Tangent cones to positive-(1,1) De Rham currents*, preprint 2011.

**Invited
talks**

- 31.03.2009: *The singular set of Special Legendrian integral cycles in S^5* , Three-City-Seminar in Analysis at ETH Zürich.
- 13.01.2011: *Some Minimal Integral Currents in Geometry: the Calibrated Ones*, ERC School on Analysis in Metric Spaces and Geometric Measure Theory, Scuola Normale Superiore, Pisa.
- 22.02.2011: *The singular set of Special Legendrian integral cycles in S^5* , Research Seminar at Imperial College, London.
- 25.02.2011: *Calibrated Integral Currents in Geometry*, London Geometry and Topology Seminar, Imperial College.
- 01.06.2011: *Calibrated Integral Currents in Geometry*, Differential Geometry Seminar, University of Cambridge.

Awards

- 2010-2011 Swiss Polytechnic Federal Institute Graduate Research Fellowship
ETH-0109-3 for the project *The singular set of calibrated currents*.
- 2010 Swiss National Science Foundation Graduate Research Fellowship
200021-126489 for the project *The analysis of singular or blow up sets for solutions to PDE's arising in physics and geometry*.
- 2001-2006 Scuola Normale Superiore Mathematics Scholarship .